

EXPLODED DRAWING A

Model No. NTEX78214.0 R0115A

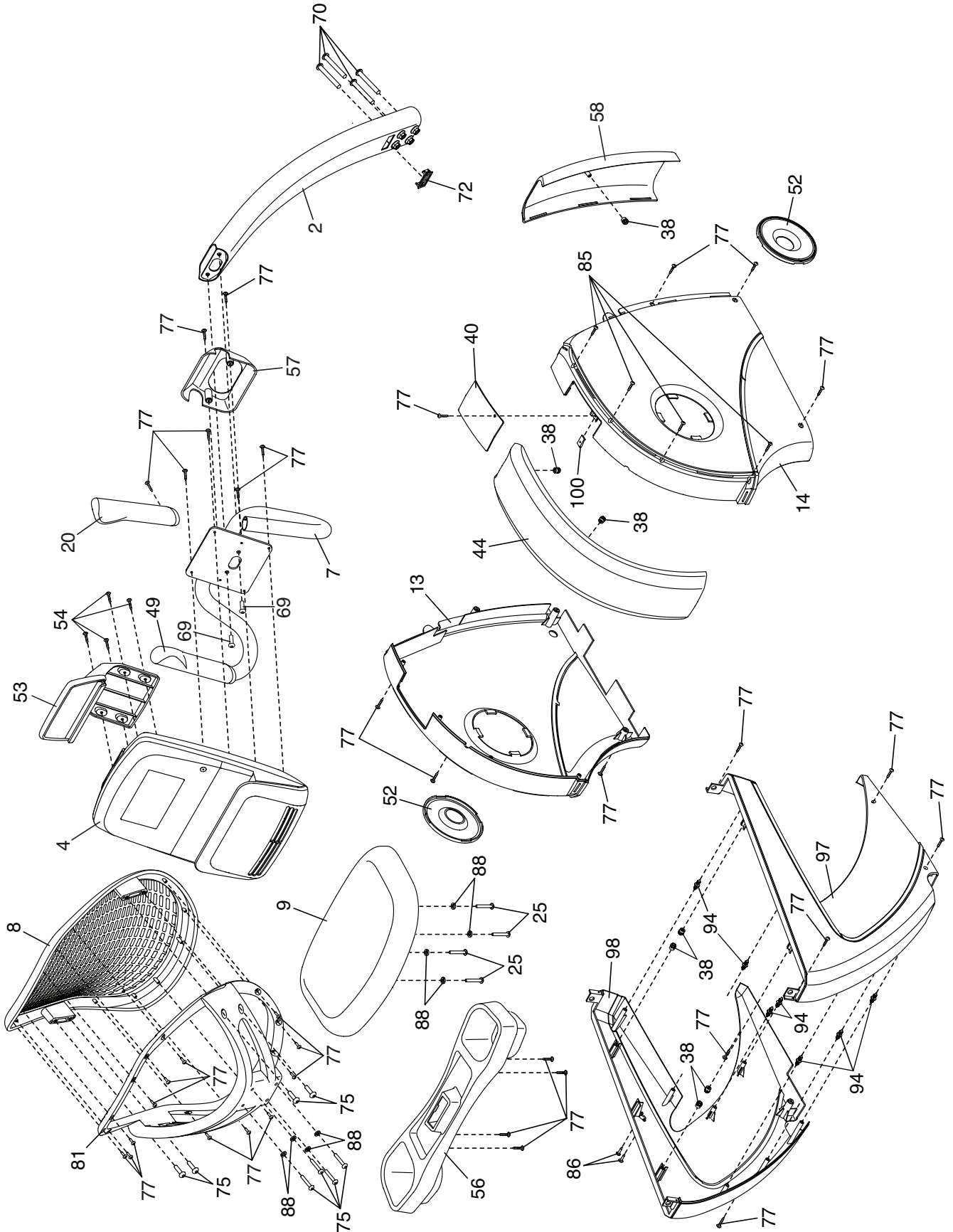

EXPLODED DRAWING B

Model No. NTEX78214.0 R0115A

