

EXPLODED DRAWING A

Model No. NTEX89918.0 R0118A

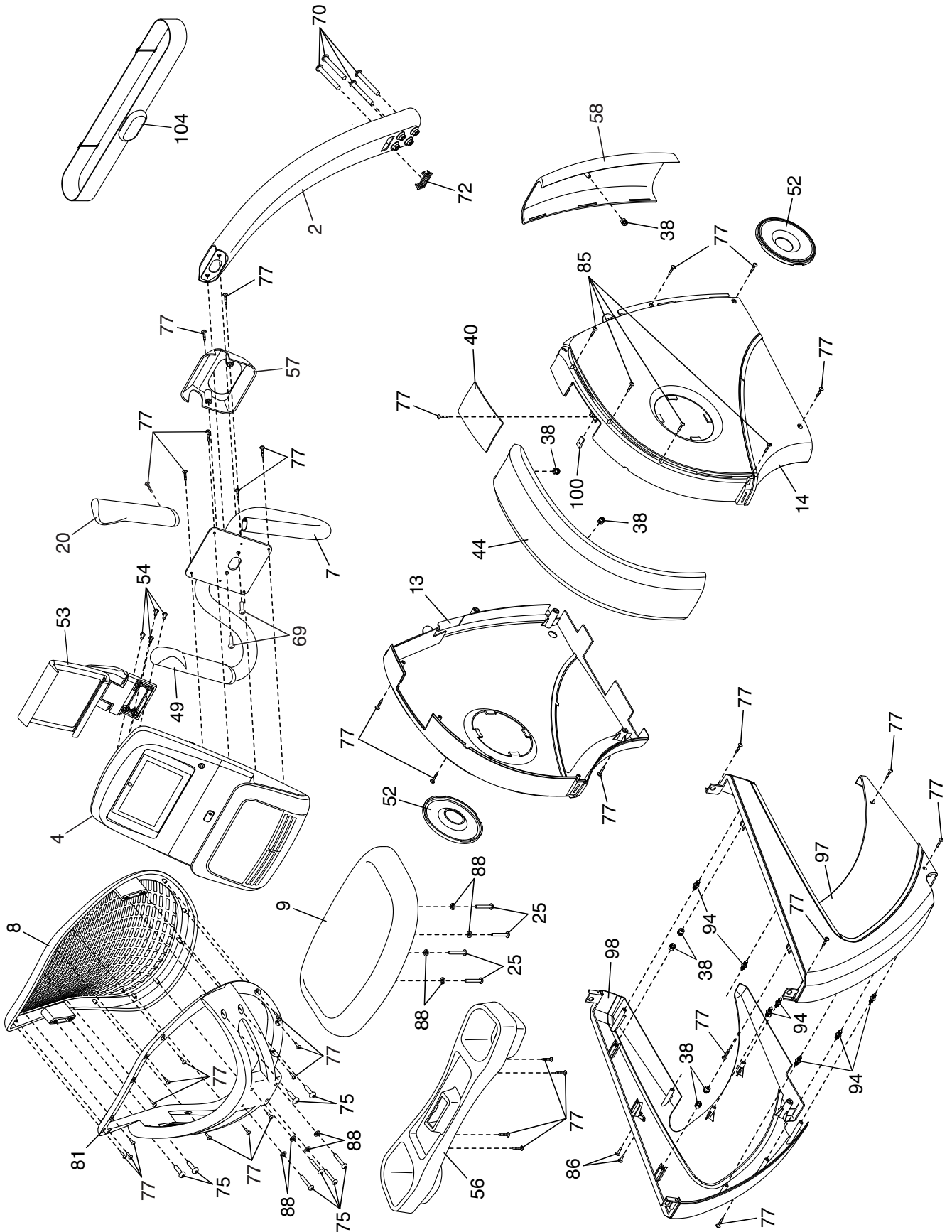

EXPLODED DRAWING B

Model No. NTEX89918.0 R0118A

