

GEDETAILEERDE TEKENING A

Modelnr. NTIVEL49416.3 R1117A

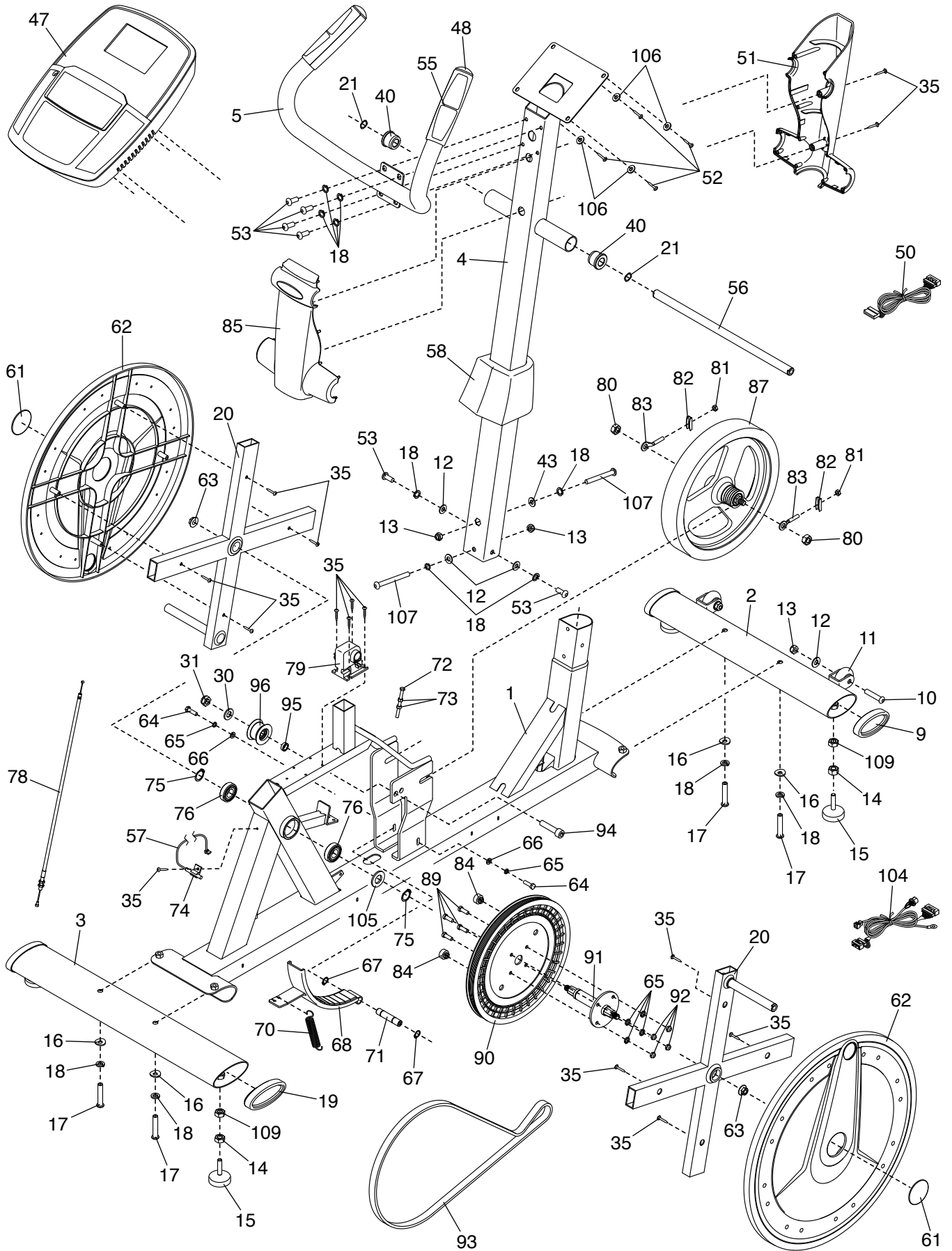

GEDETAILEERDE TEKENING B

Modelnr. NTIVEL49416.3 R1117A

