

# EXPLODED DRAWING A—Model No. NTL01109.0

R0110A

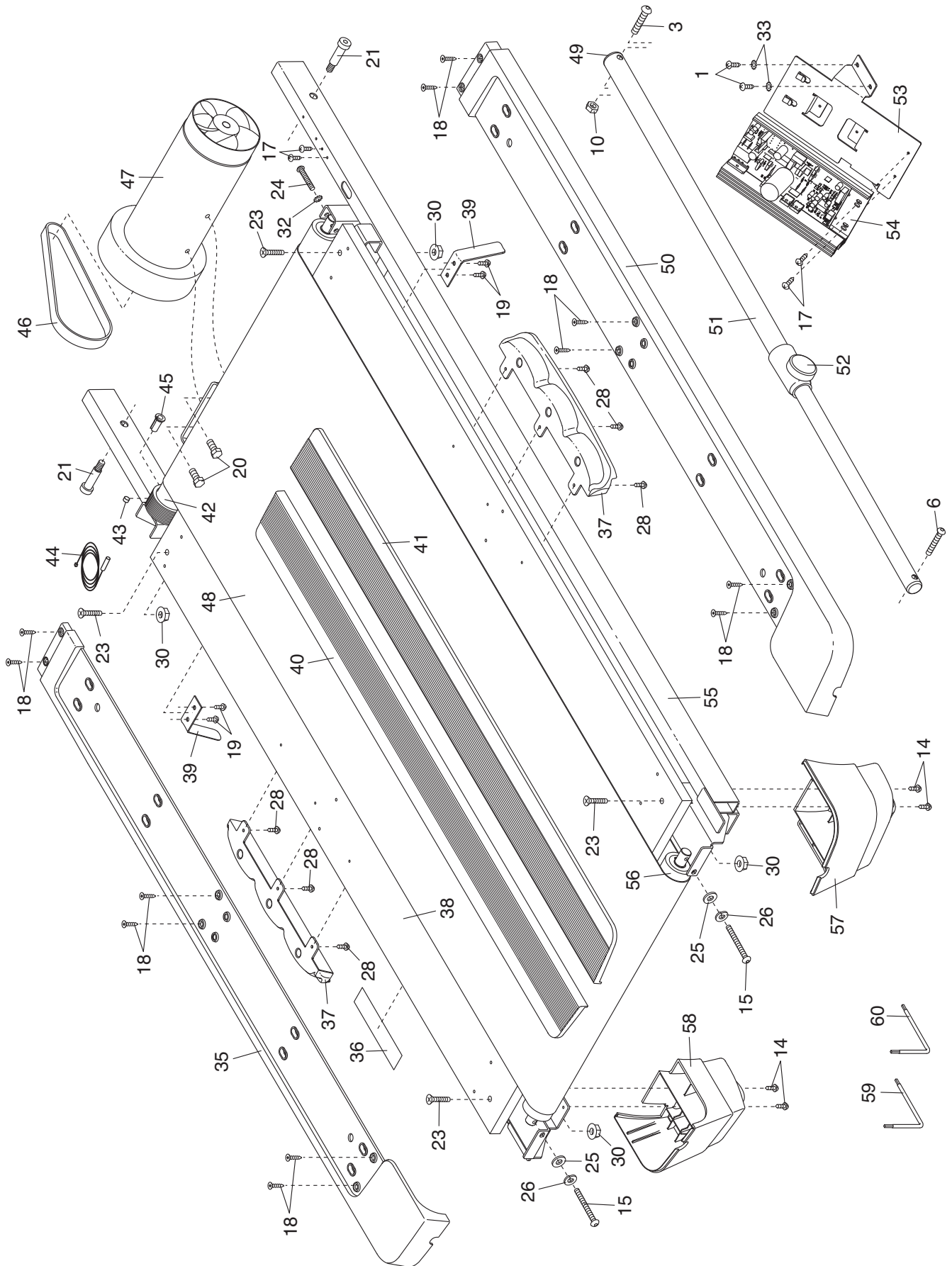

# EXPLODED DRAWING B—Model No. NTL01109.0

R0110A

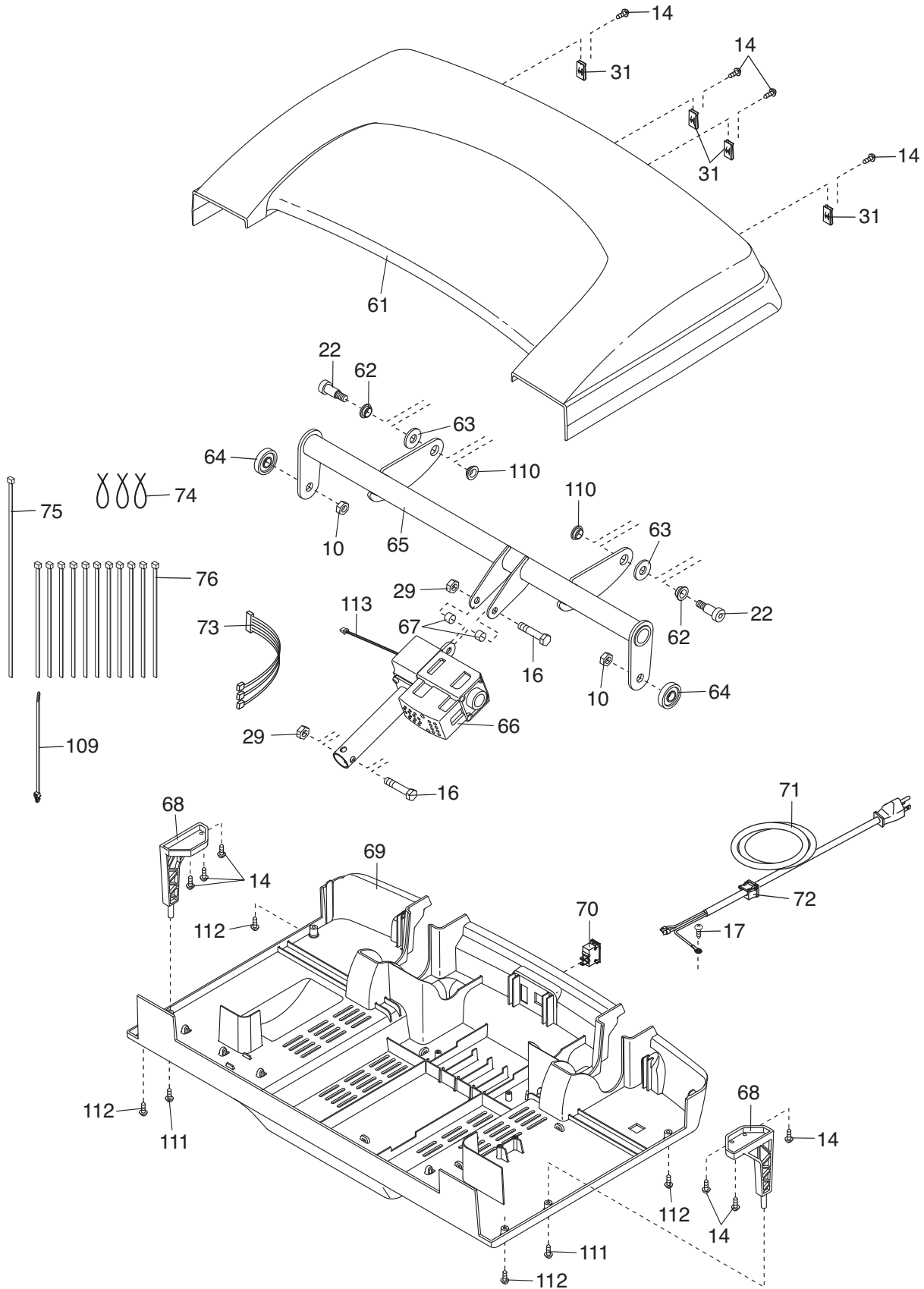

# EXPLODED DRAWING C—Model No. NTL01109.0

R0110A

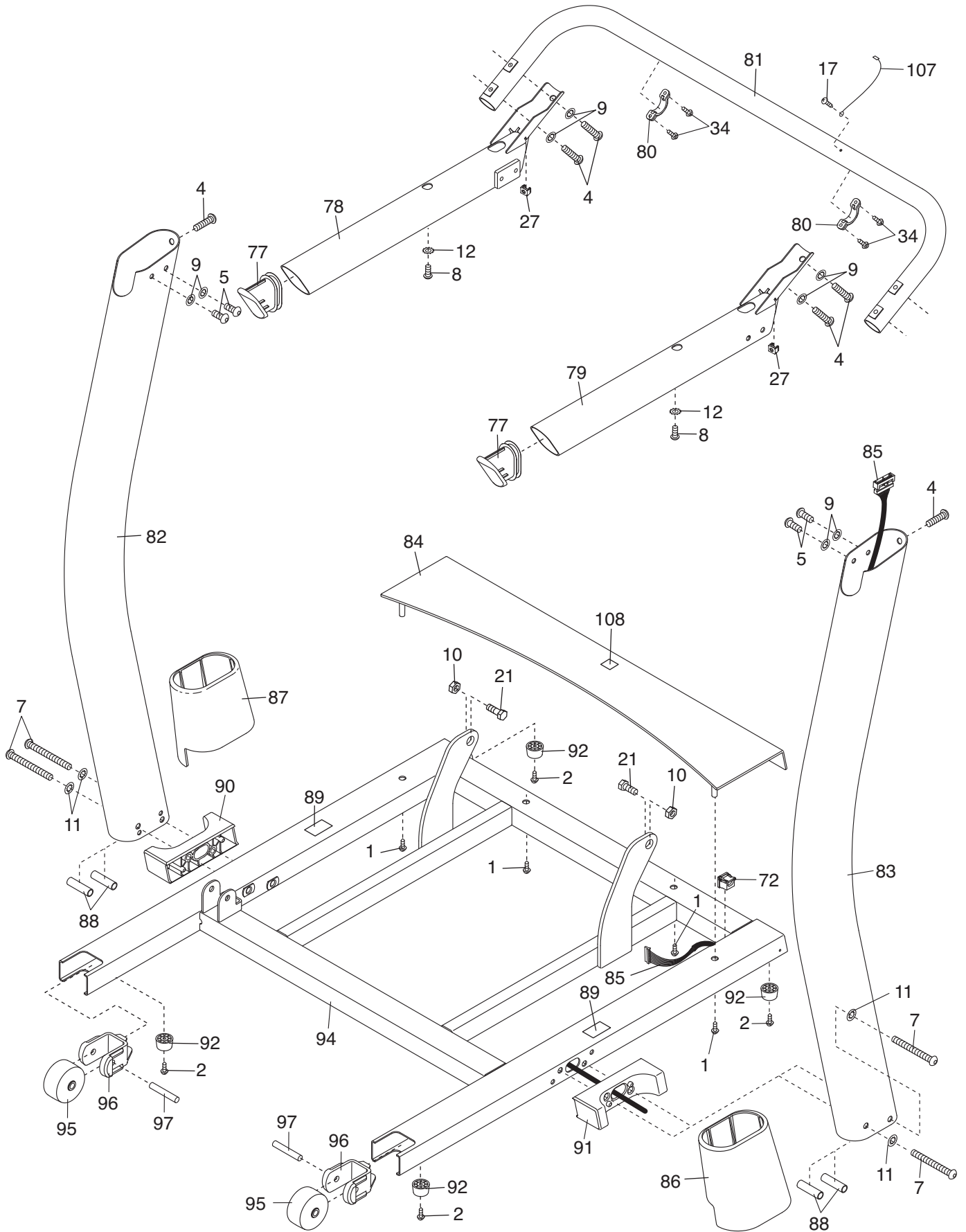

# EXPLODED DRAWING D—Model No. NTL01109.0

R0110A

