

EXPLODED DRAWING A—Model No. NTL07707.2

R1007A

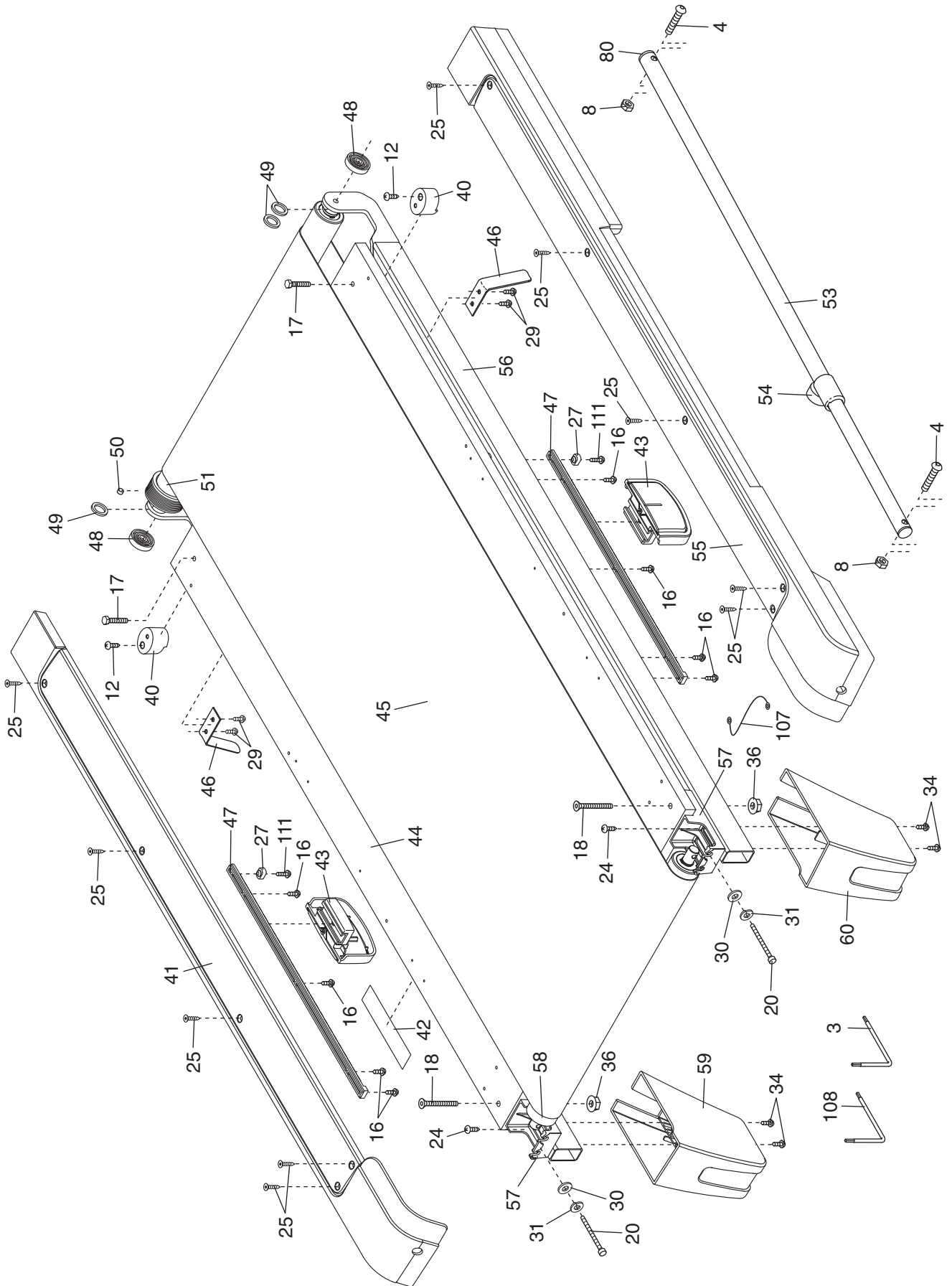

EXPLODED DRAWING B—Model No. NTL07707.2

R1007A

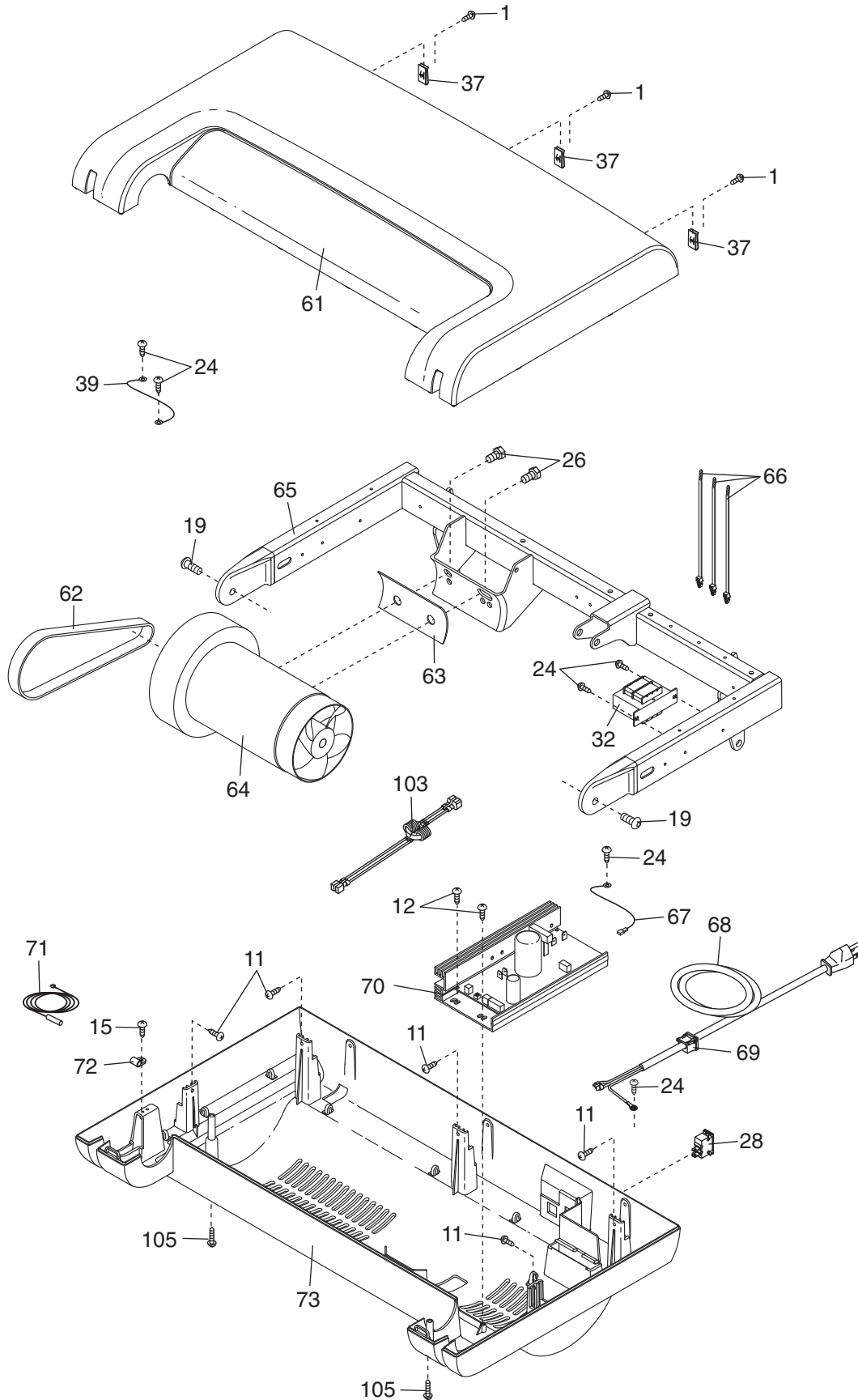

EXPLODED DRAWING C—Model No. NTL07707.2

R1007A

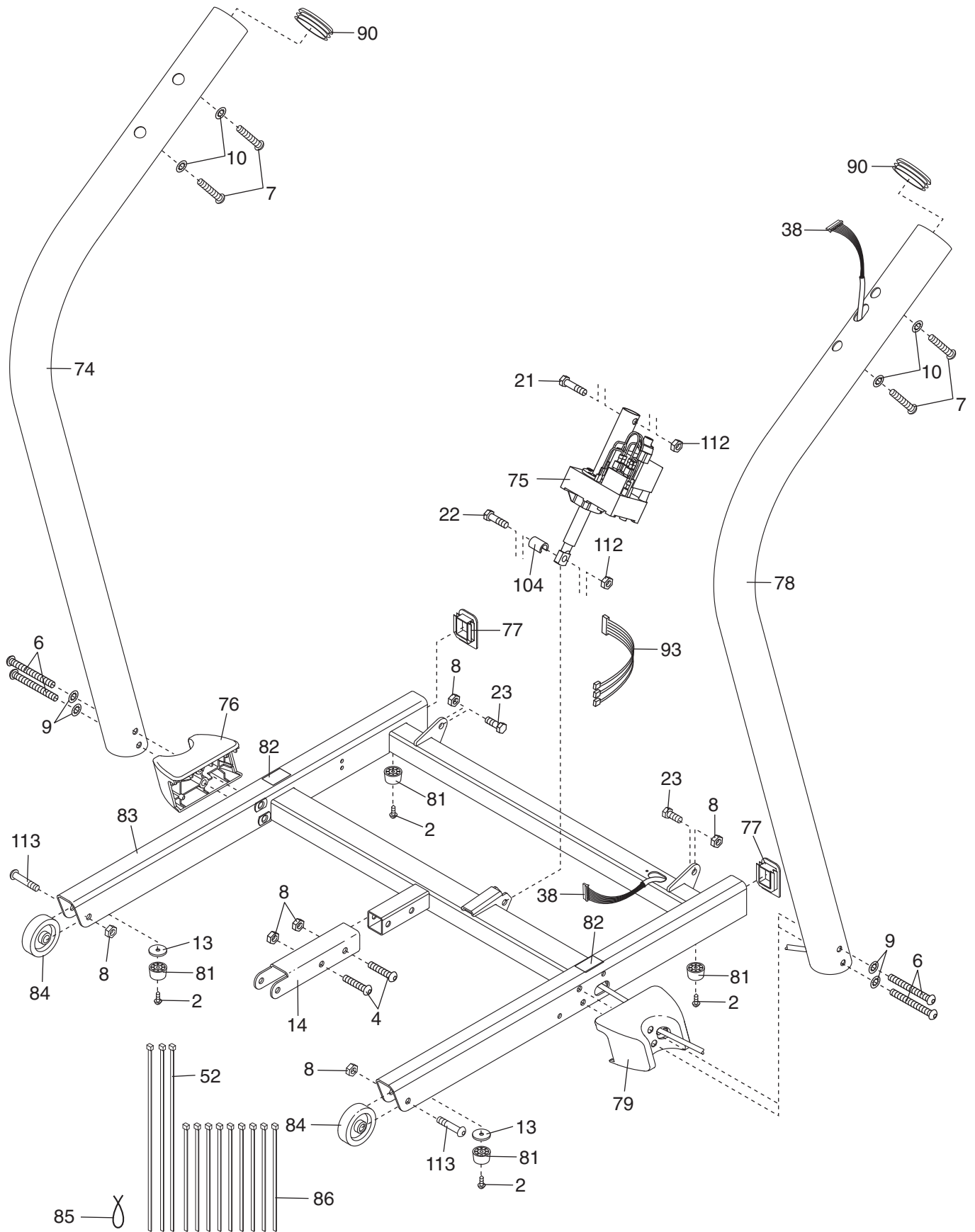

EXPLODED DRAWING D—Model No. NTL07707.2

R1007A

