

# EXPLODED DRAWING A—Model No. NTL07806.2

R0407A

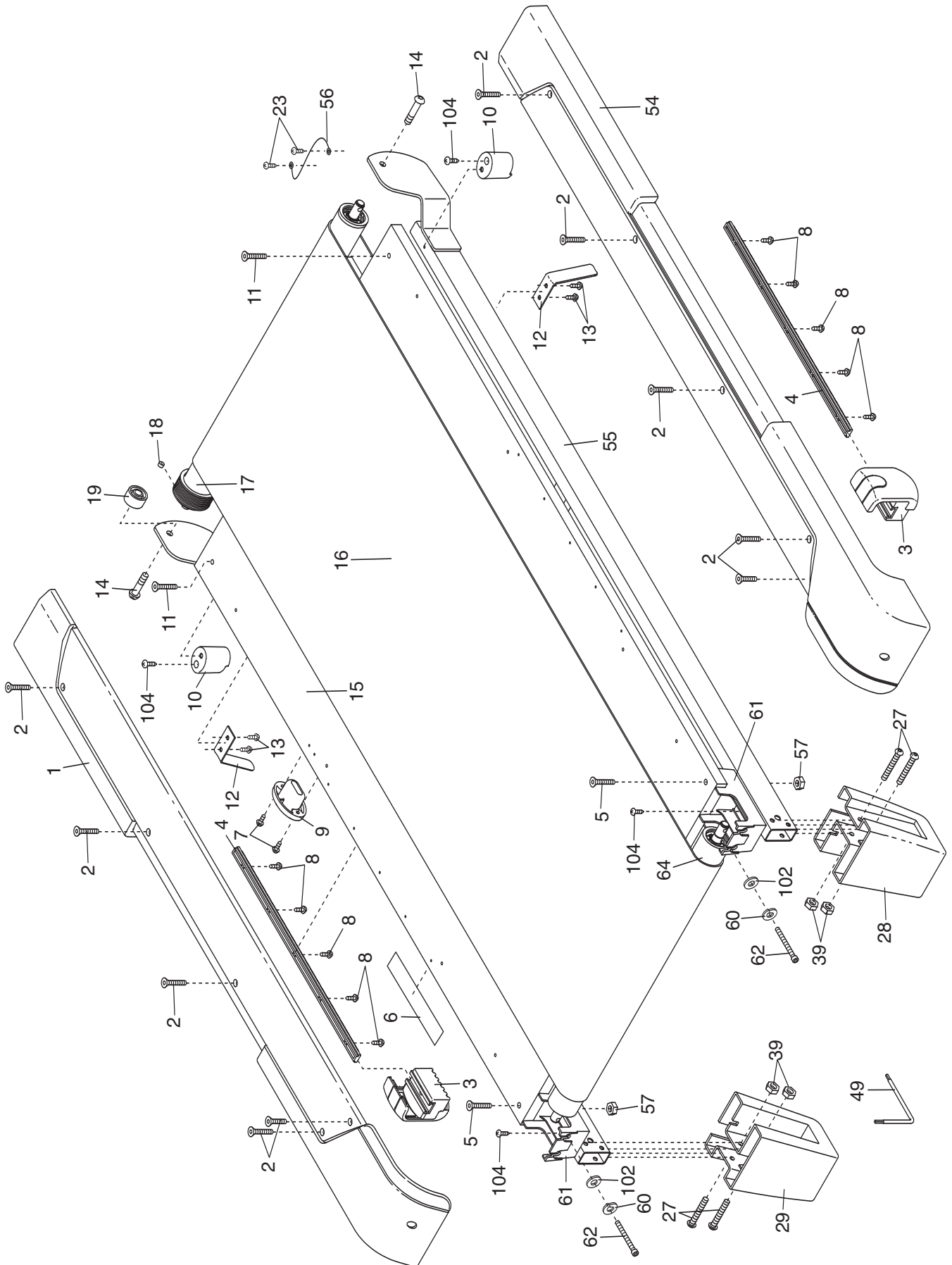

# EXPLODED DRAWING B—Model No. NTL07806.2

R0407A

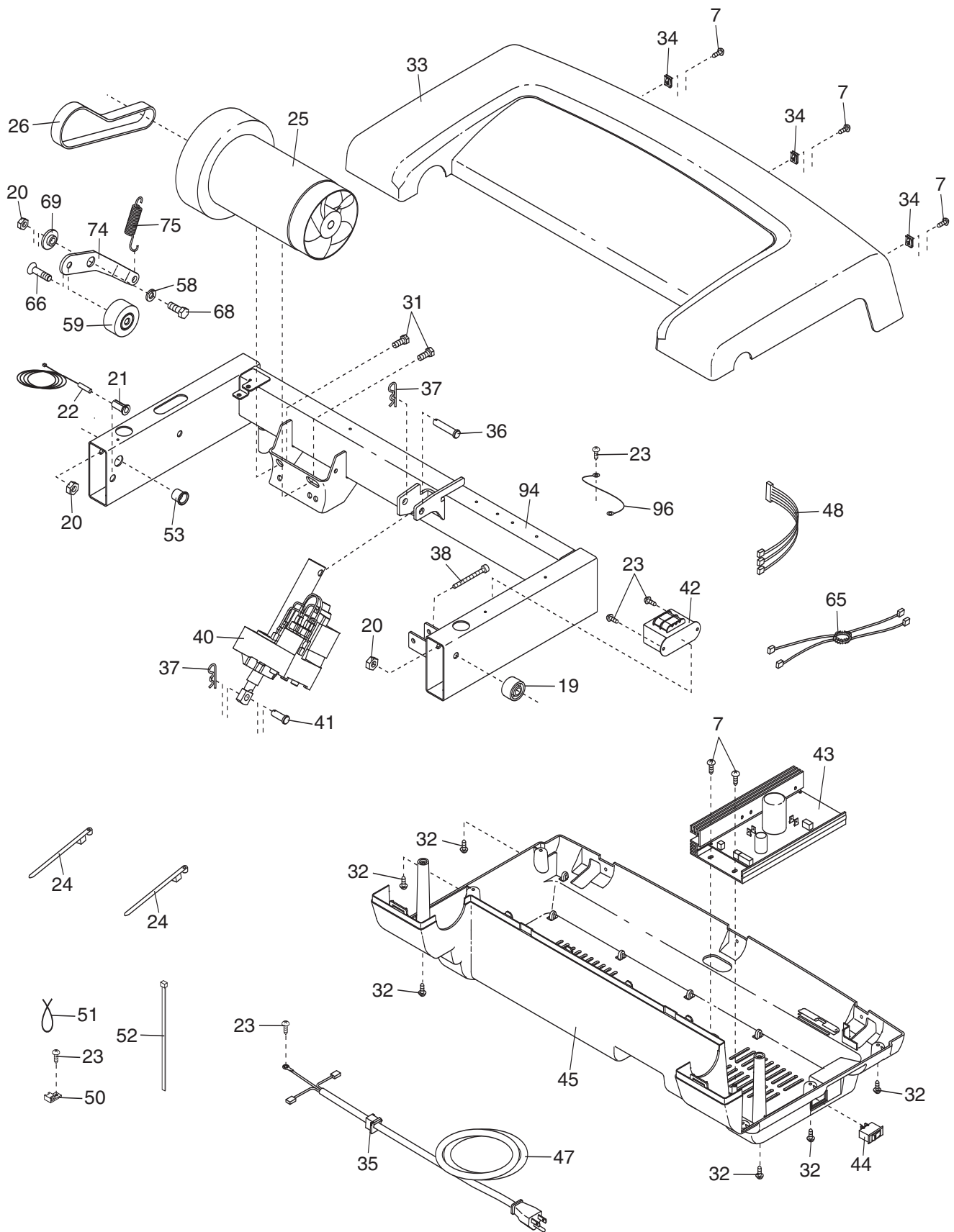

# EXPLODED DRAWING C—Model No. NTL07806.2

R0407A

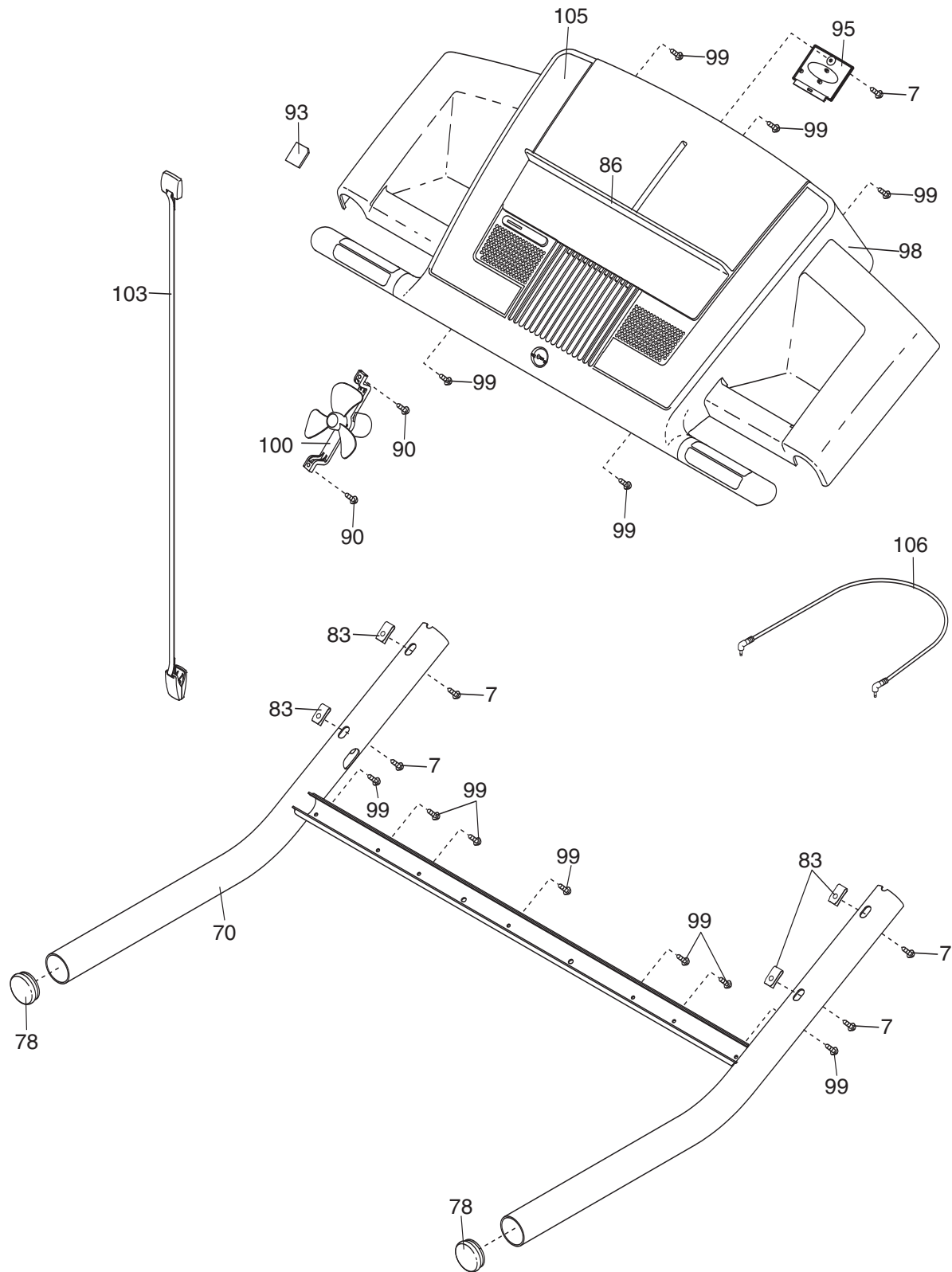

# EXPLODED DRAWING D—Model No. NTL07806.2

R0407A

