

# EXPLODED DRAWING A

Model No. NTL11010.4 R1011A

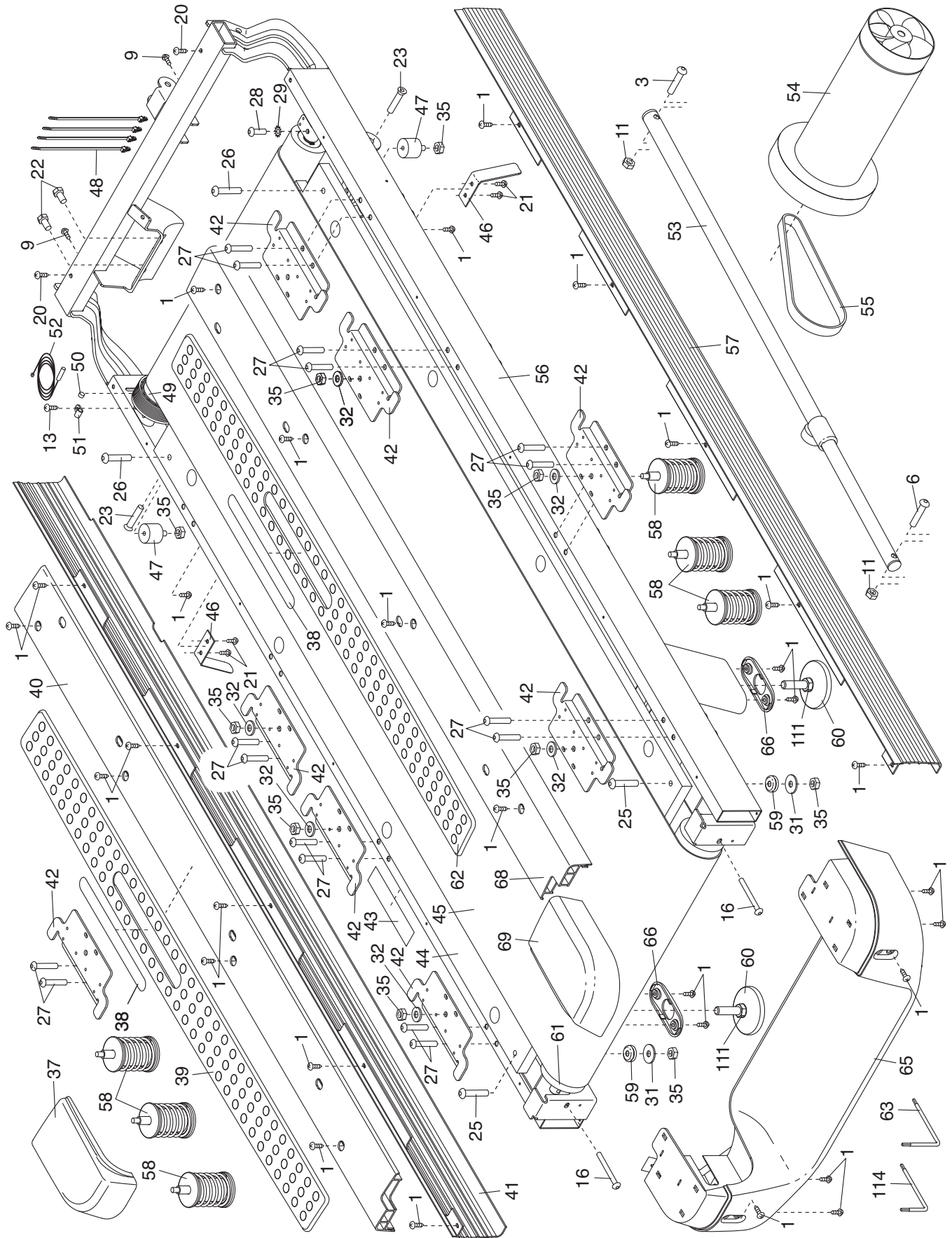

# EXPLODED DRAWING B

Model No. NTL11010.4 R1011A

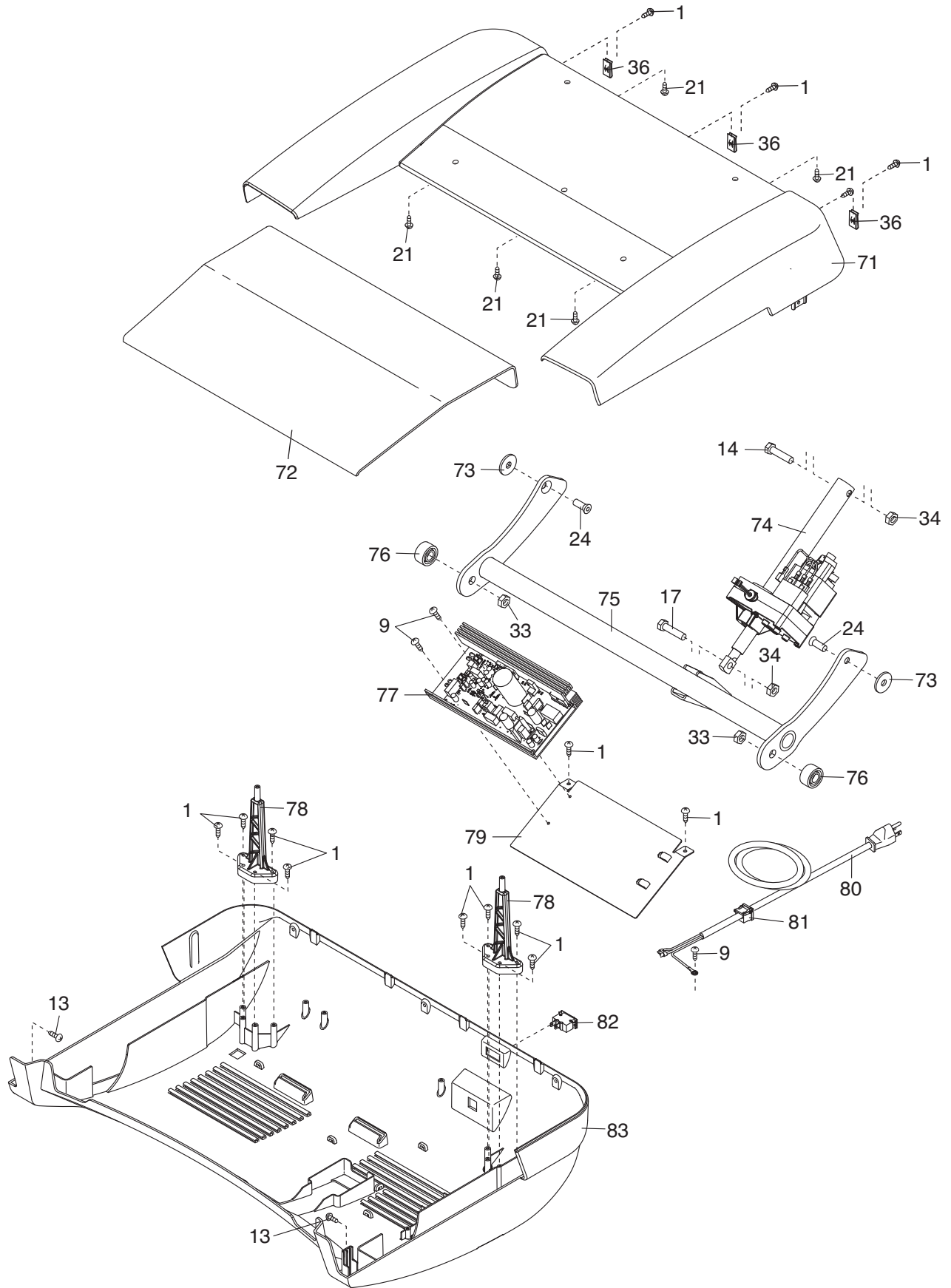

# EXPLODED DRAWING C

Model No. NTL11010.4 R1011A

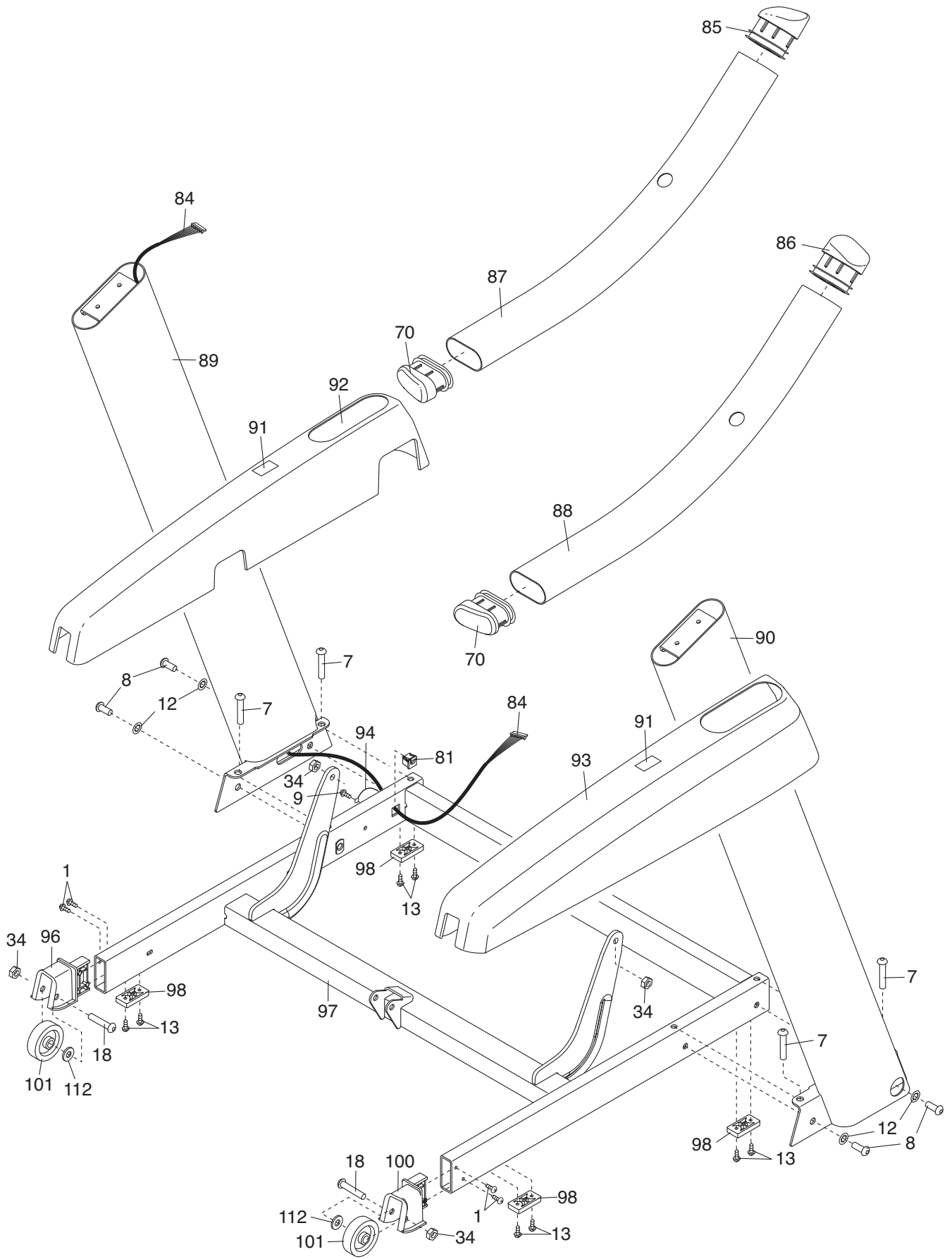

# EXPLODED DRAWING D

Model No. NTL11010.4 R1011A

