

EXPLODED DRAWING A

Model No. NTL14010.3 R0511A

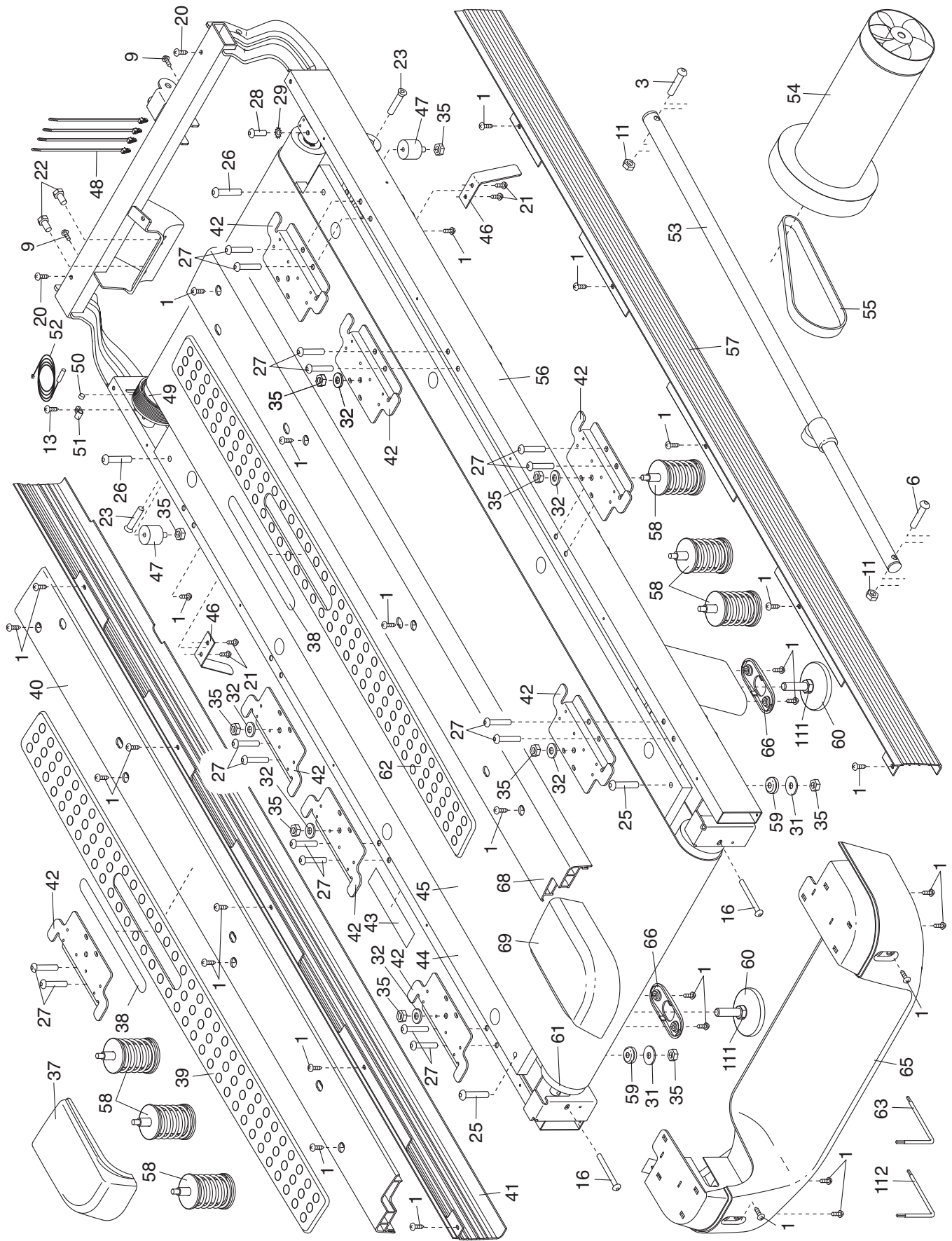

EXPLODED DRAWING B

Model No. NTL14010.3 R0511A

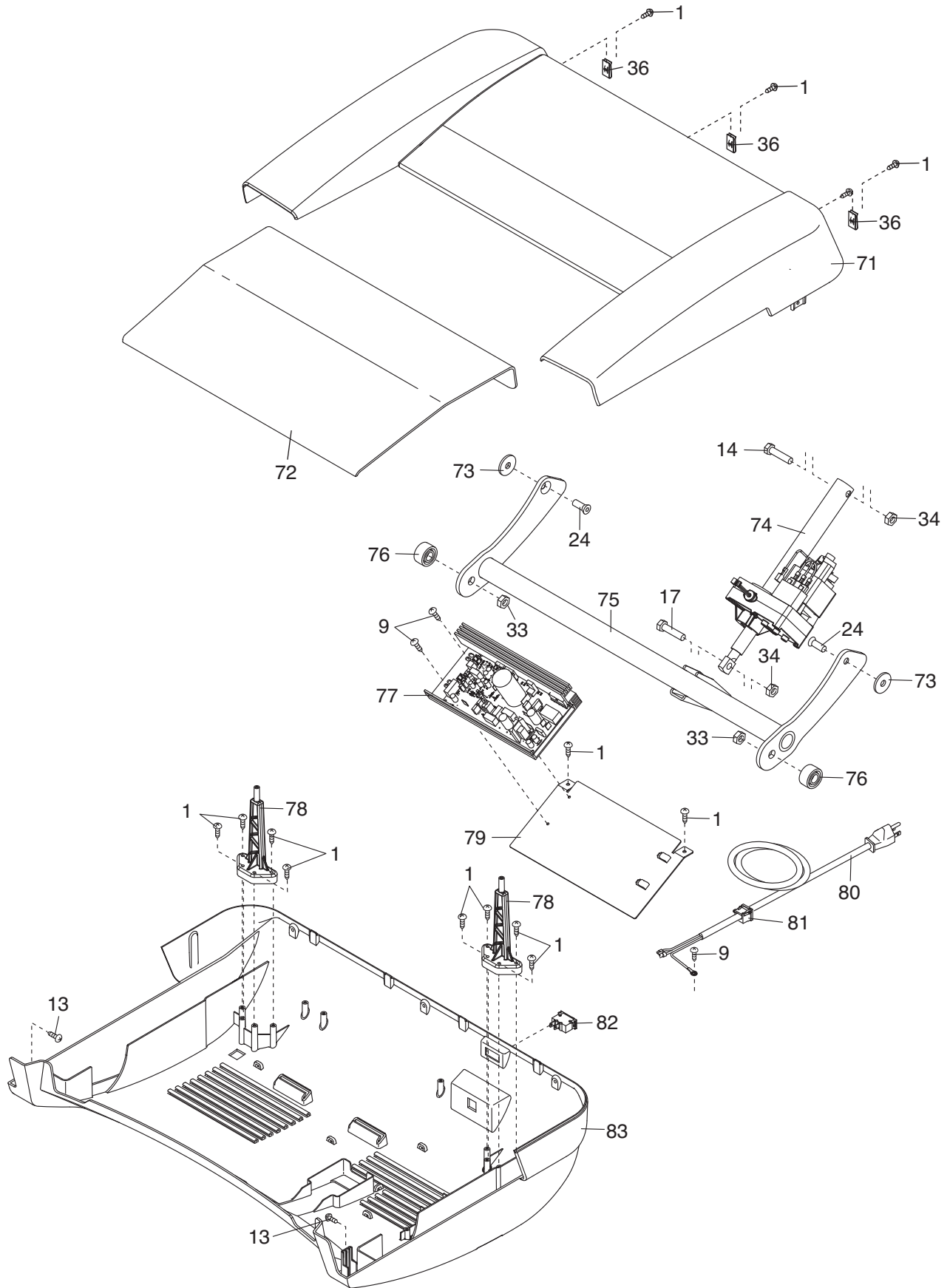

EXPLODED DRAWING C

Model No. NTL14010.3 R0511A

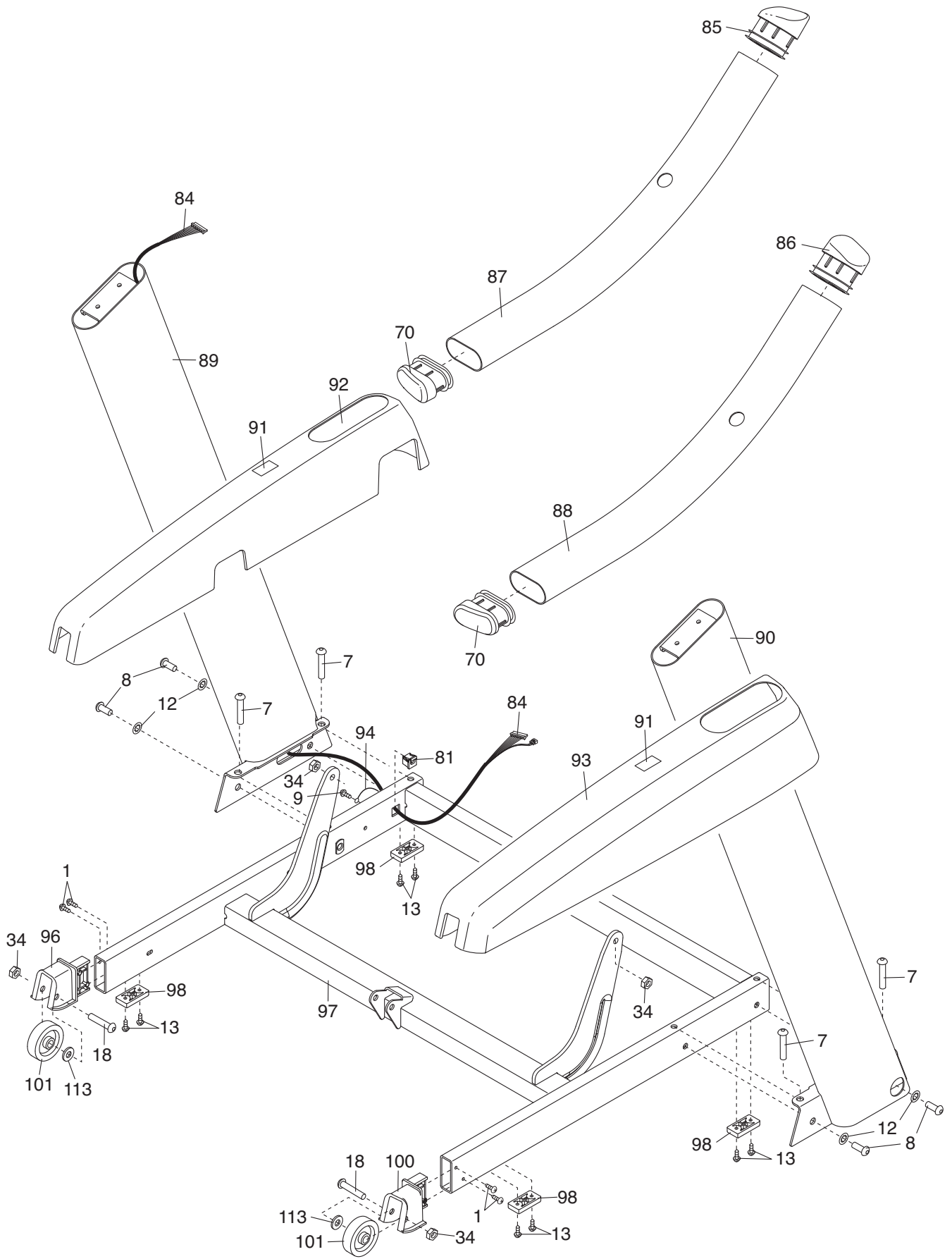

EXPLODED DRAWING D

Model No. NTL14010.3 R0511A

