

EXPLODED DRAWING A

Model No. NTL14212.0 R1212A

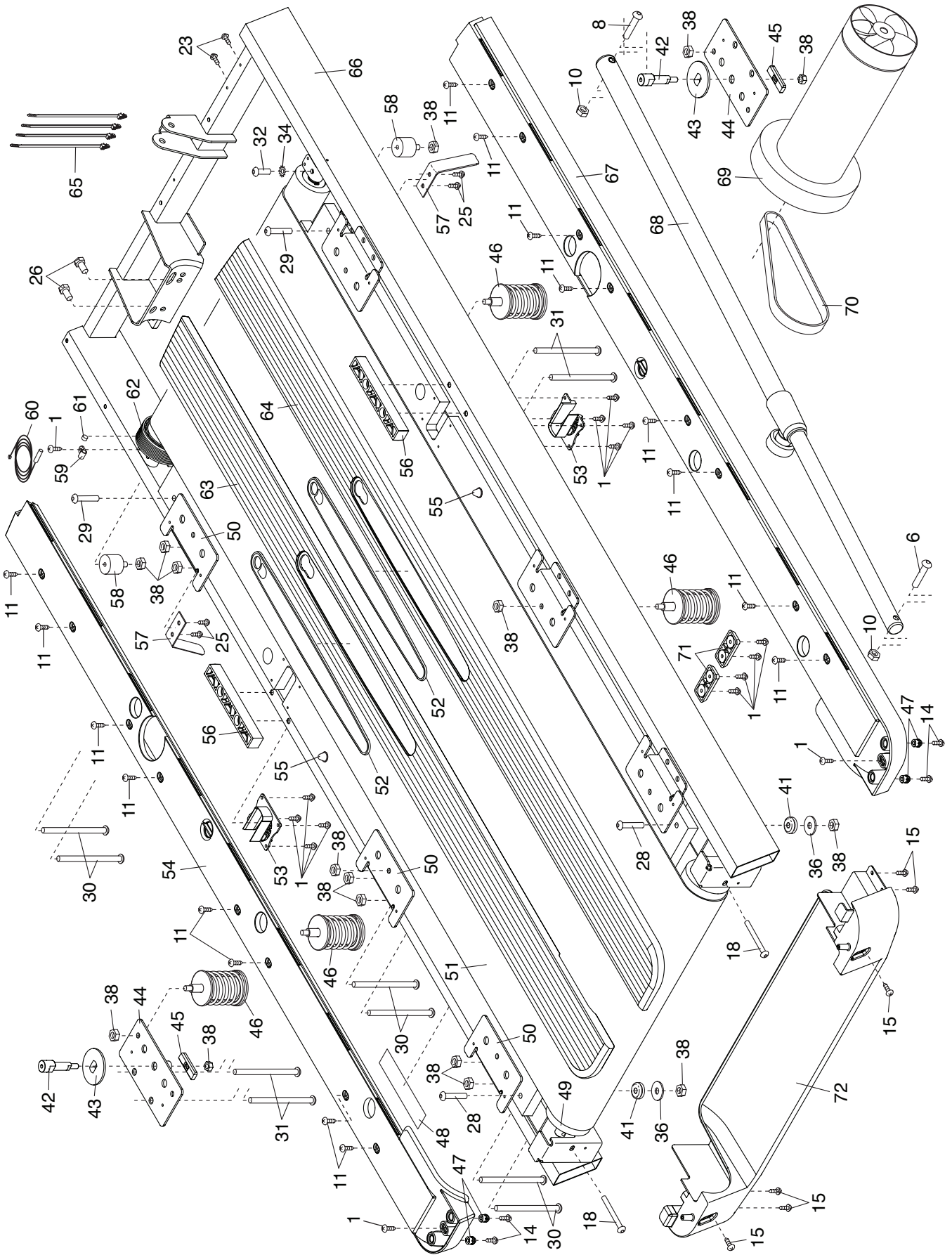

EXPLODED DRAWING B

Model No. NTL14212.0 R1212A

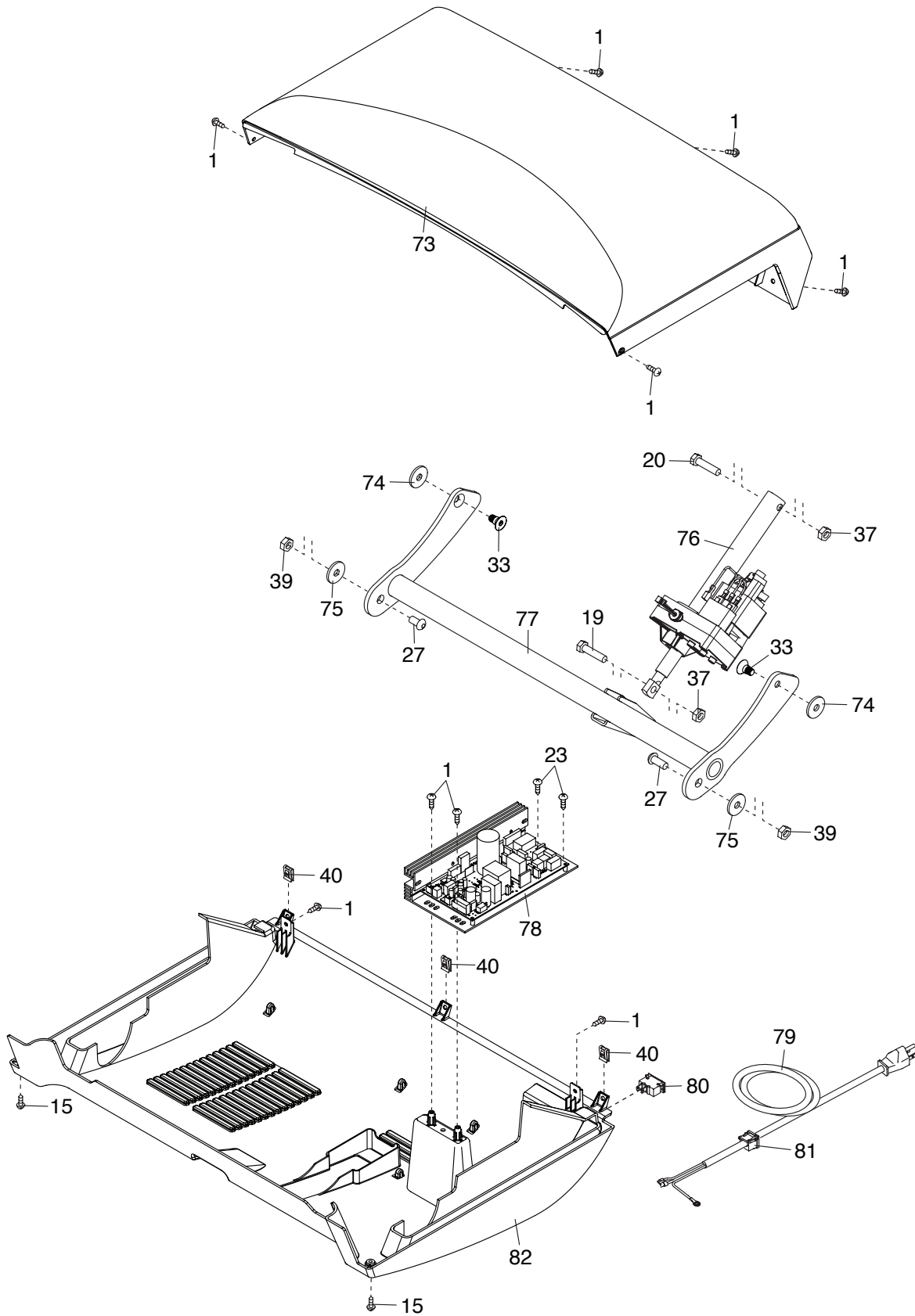

EXPLODED DRAWING C

Model No. NTL14212.0 R1212A

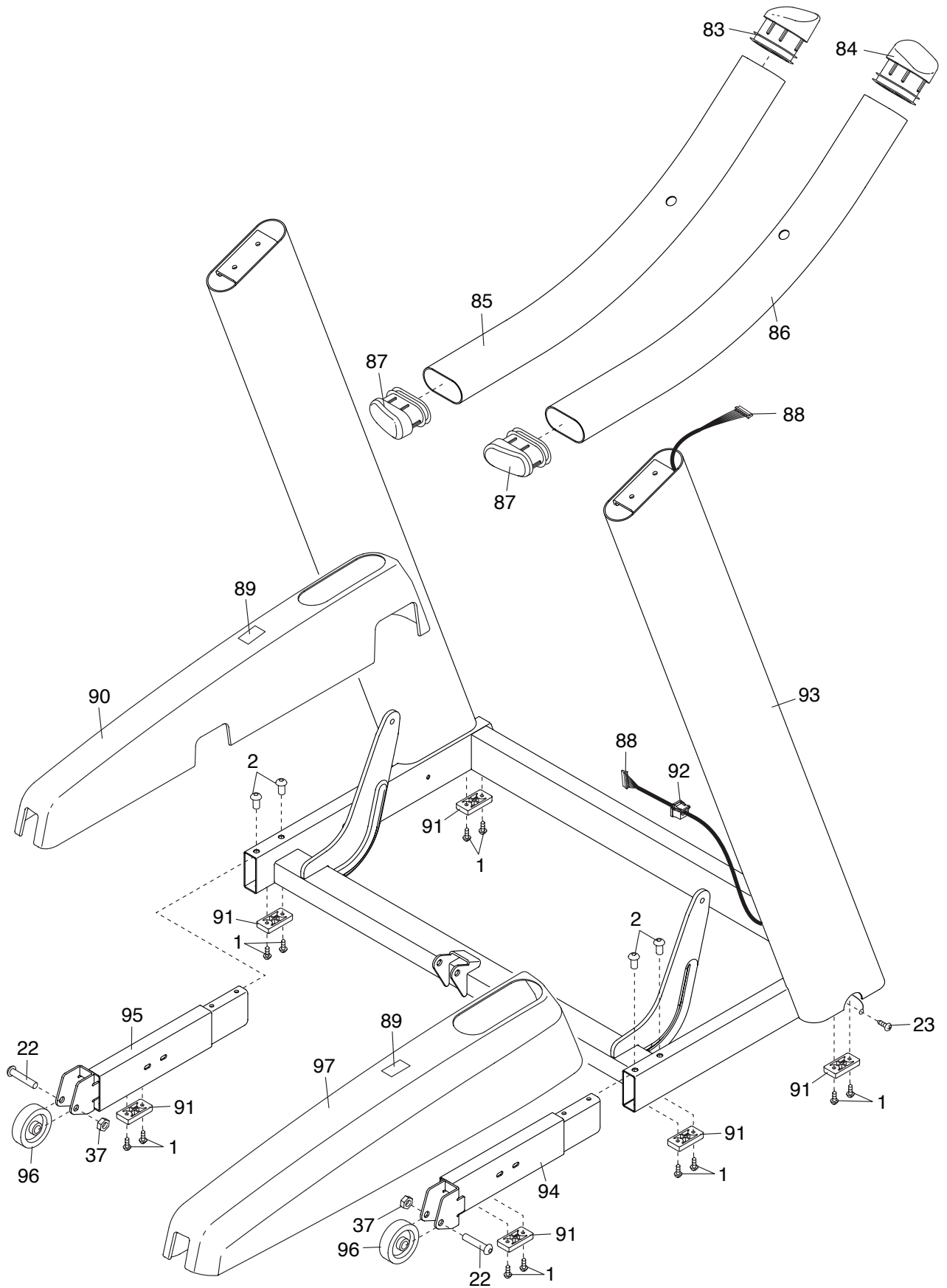

EXPLODED DRAWING D

Model No. NTL14212.0 R1212A

