

EXPLODED DRAWING A

Model No. NTL15810.0 R0111A

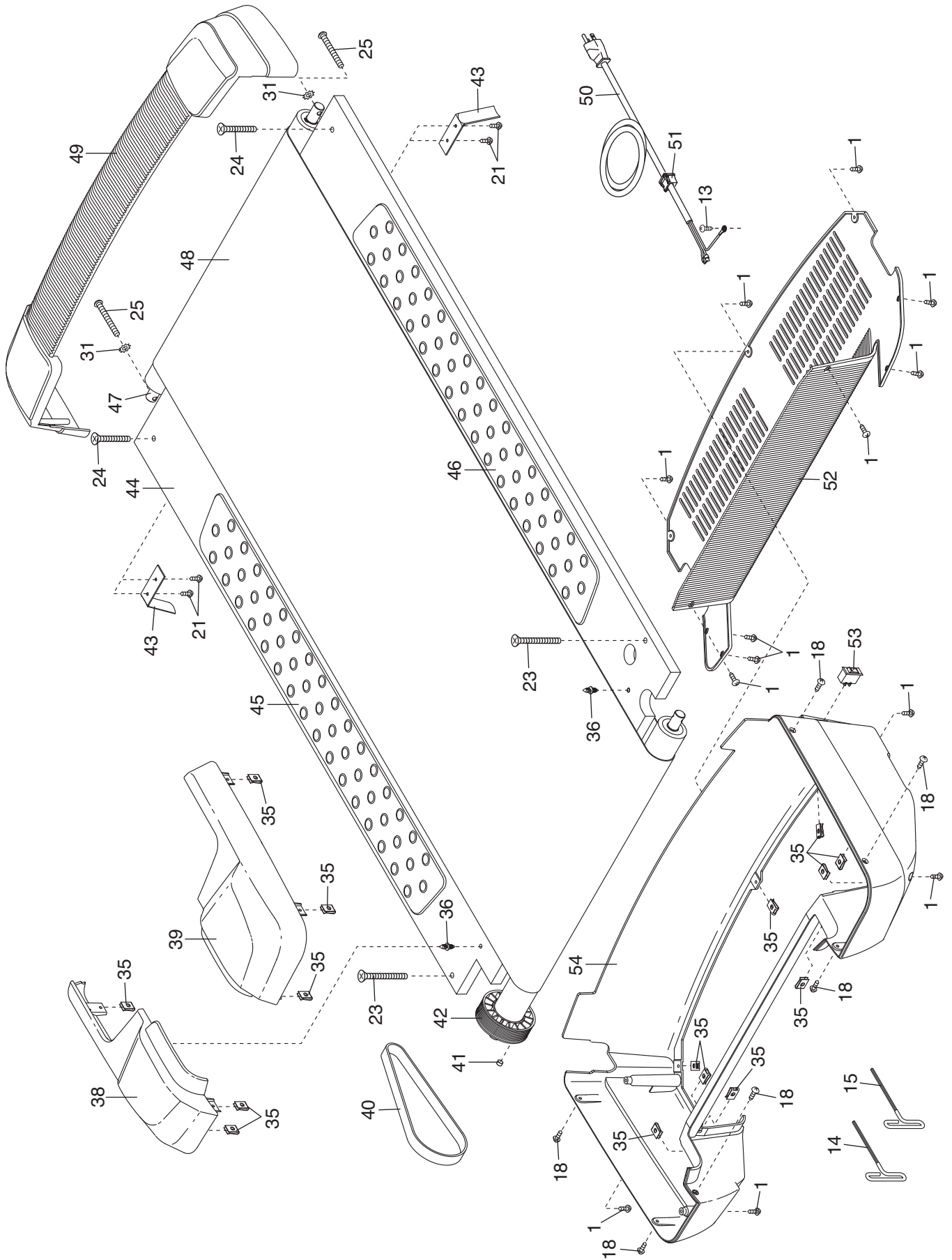

EXPLODED DRAWING B

Model No. NTL15810.0 R0111A

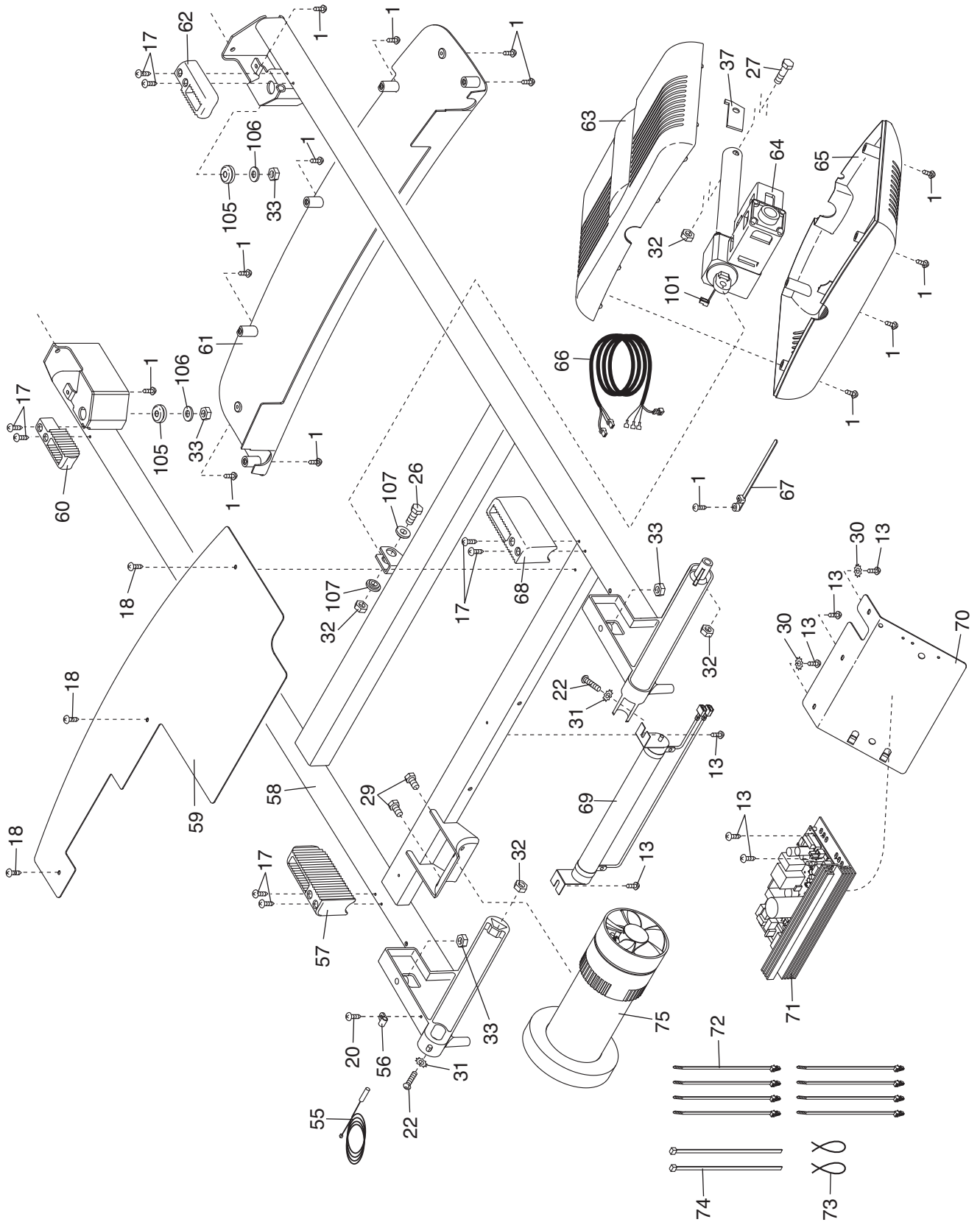

EXPLODED DRAWING C

Model No. NTL15810.0 R0111A

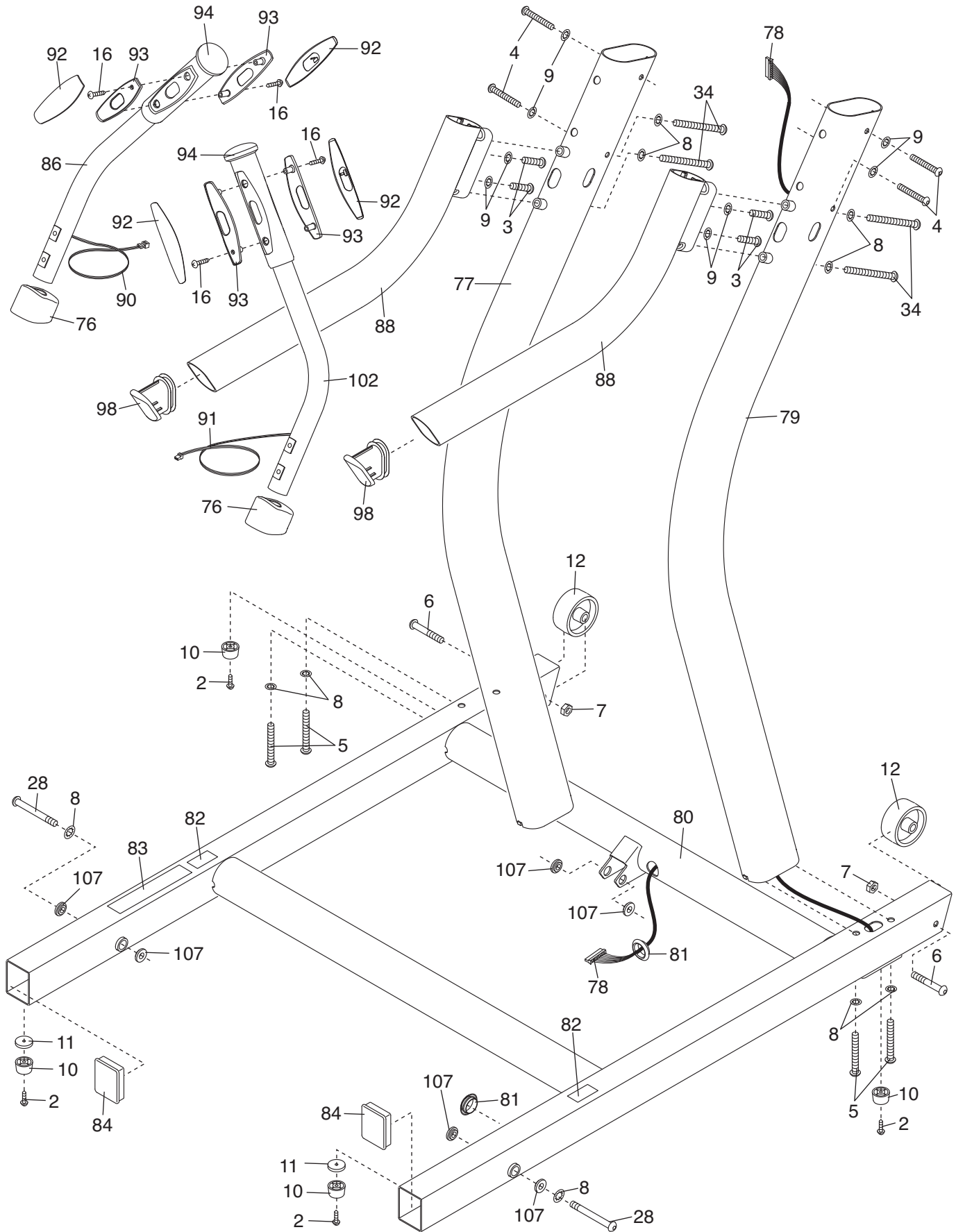

EXPLODED DRAWING D

Model No. NTL15810.0 R0111A

