

EXPLODED DRAWING B

Model No. NTL16915.0 R0915A

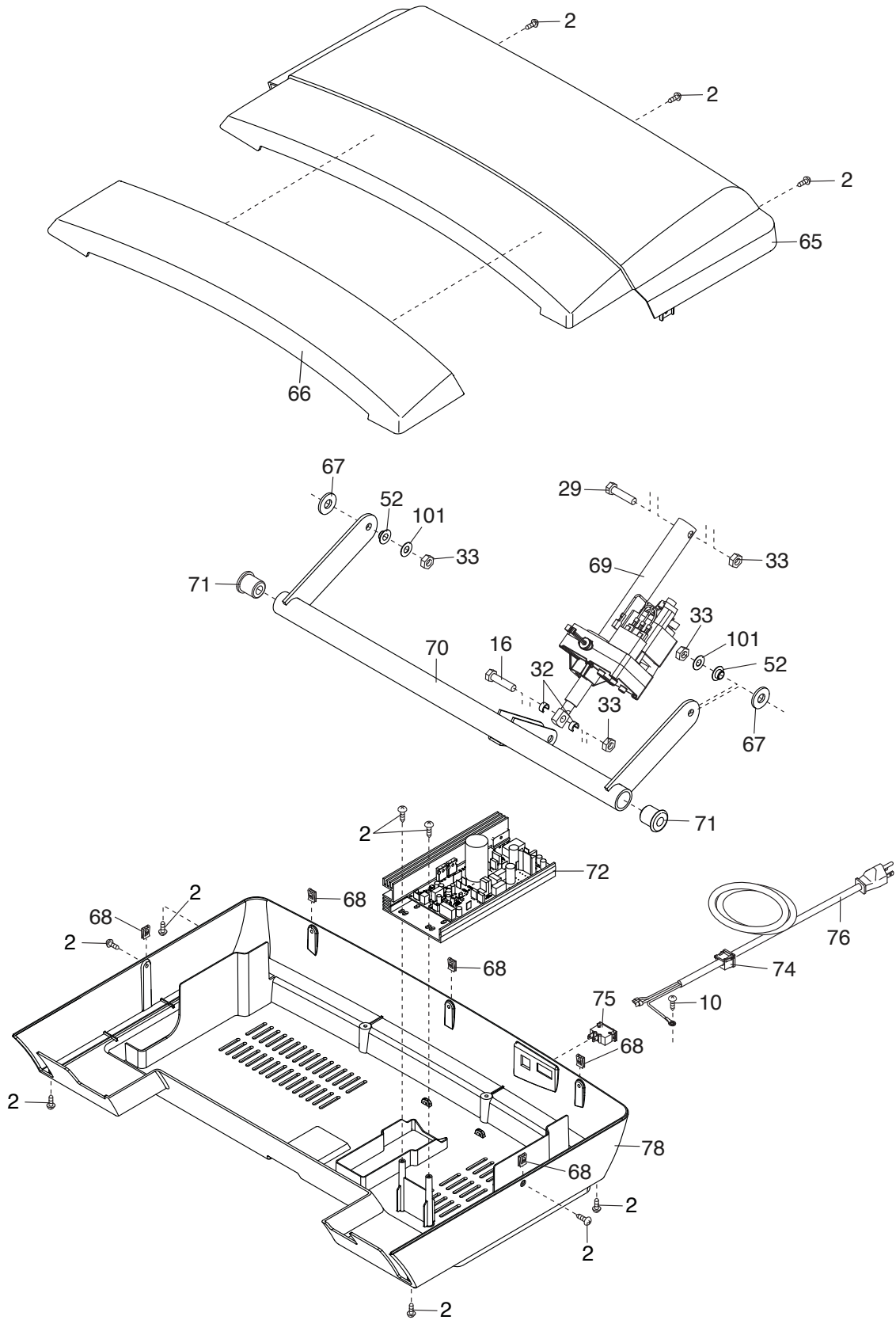

EXPLODED DRAWING C

Model No. NTL16915.0 R0915A

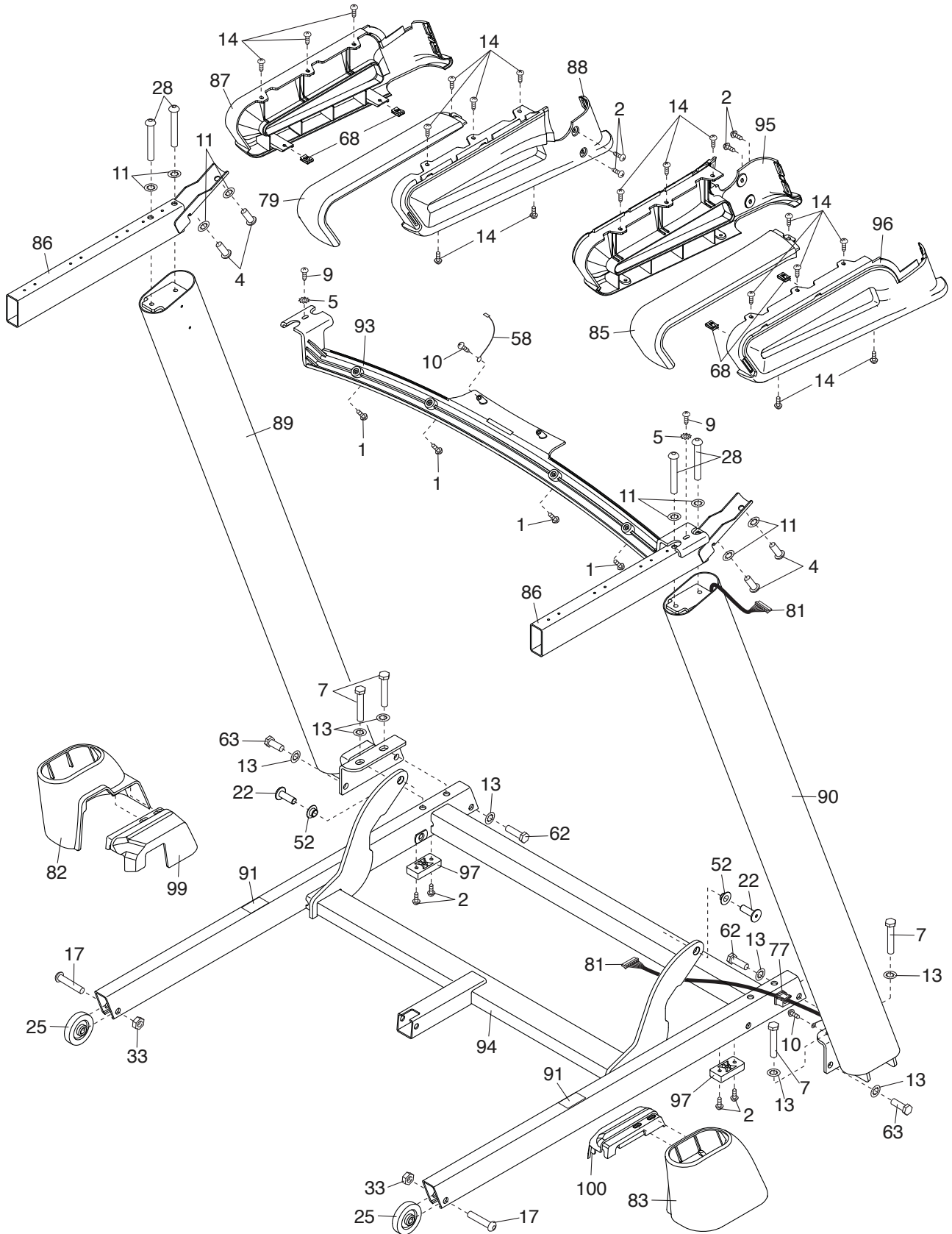

EXPLODED DRAWING D

Model No. NTL16915.0 R0915A

