

# EXPLODED DRAWING A

Model No. NTL17012.3 R0713A

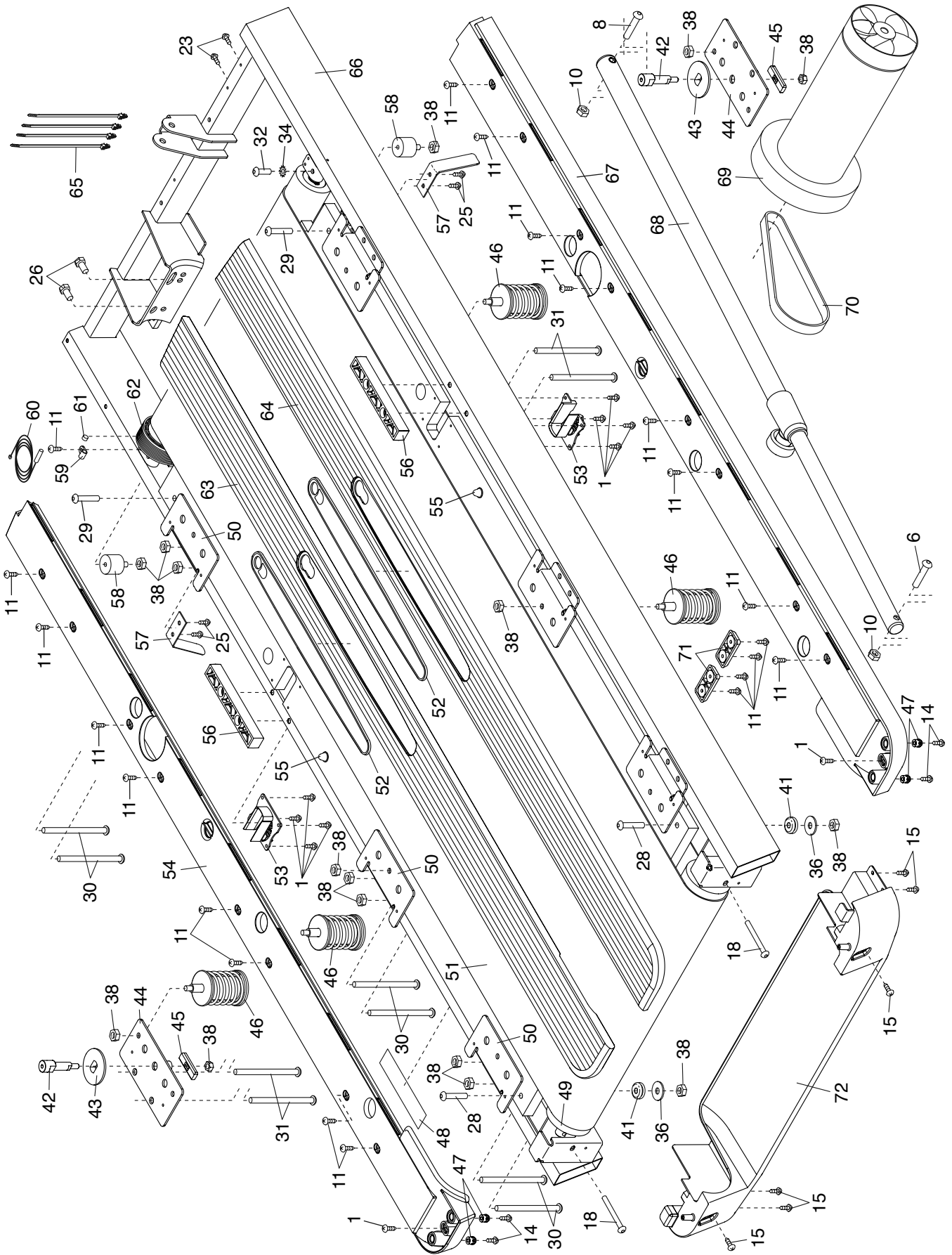

# EXPLODED DRAWING B

Model No. NTL17012.3 R0713A

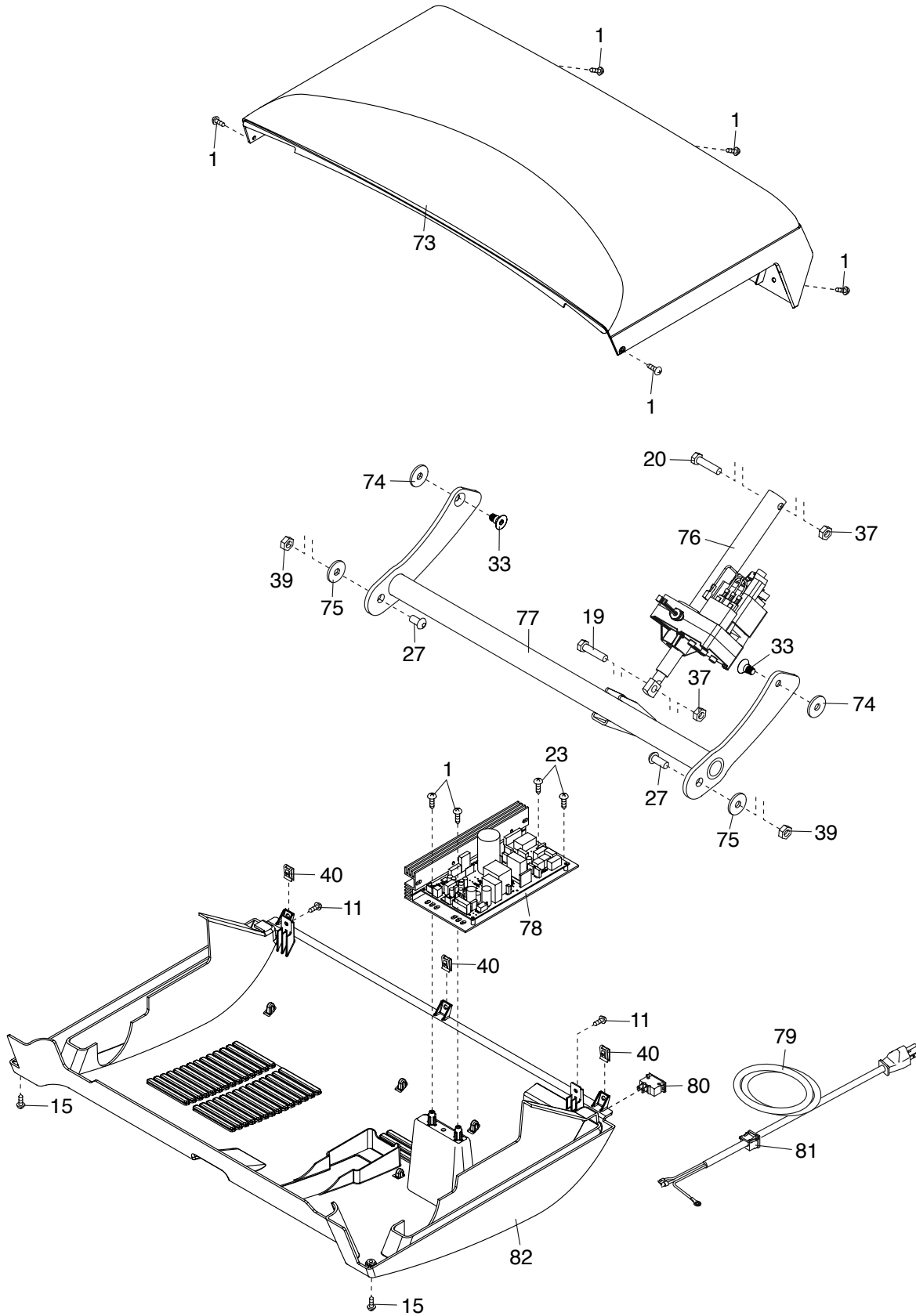

# EXPLODED DRAWING C

Model No. NTL17012.3 R0713A

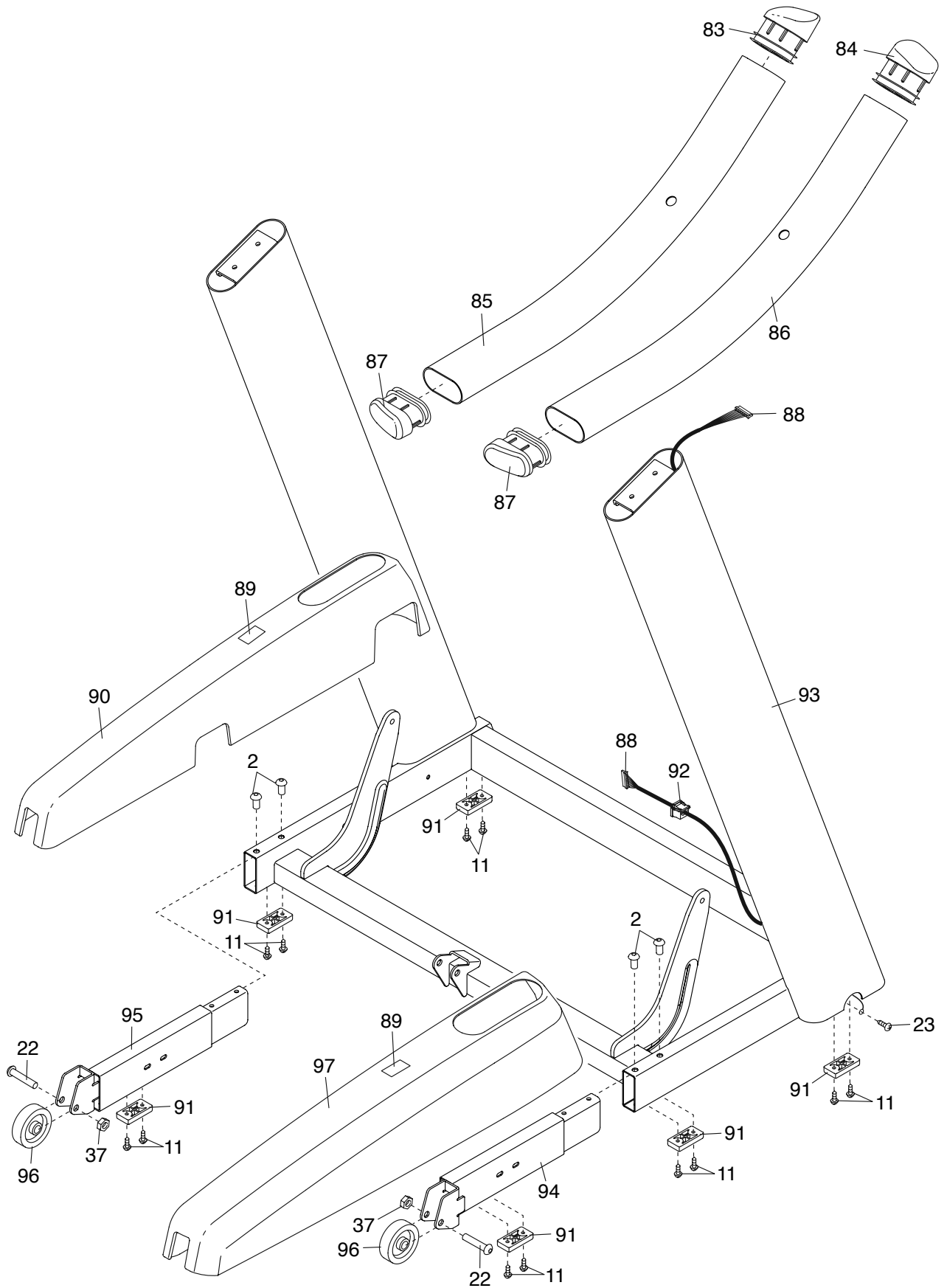

# EXPLODED DRAWING D

Model No. NTL17012.3 R0713A

