

EXPLODED DRAWING B

Model No. NTL17124.3 R1122A

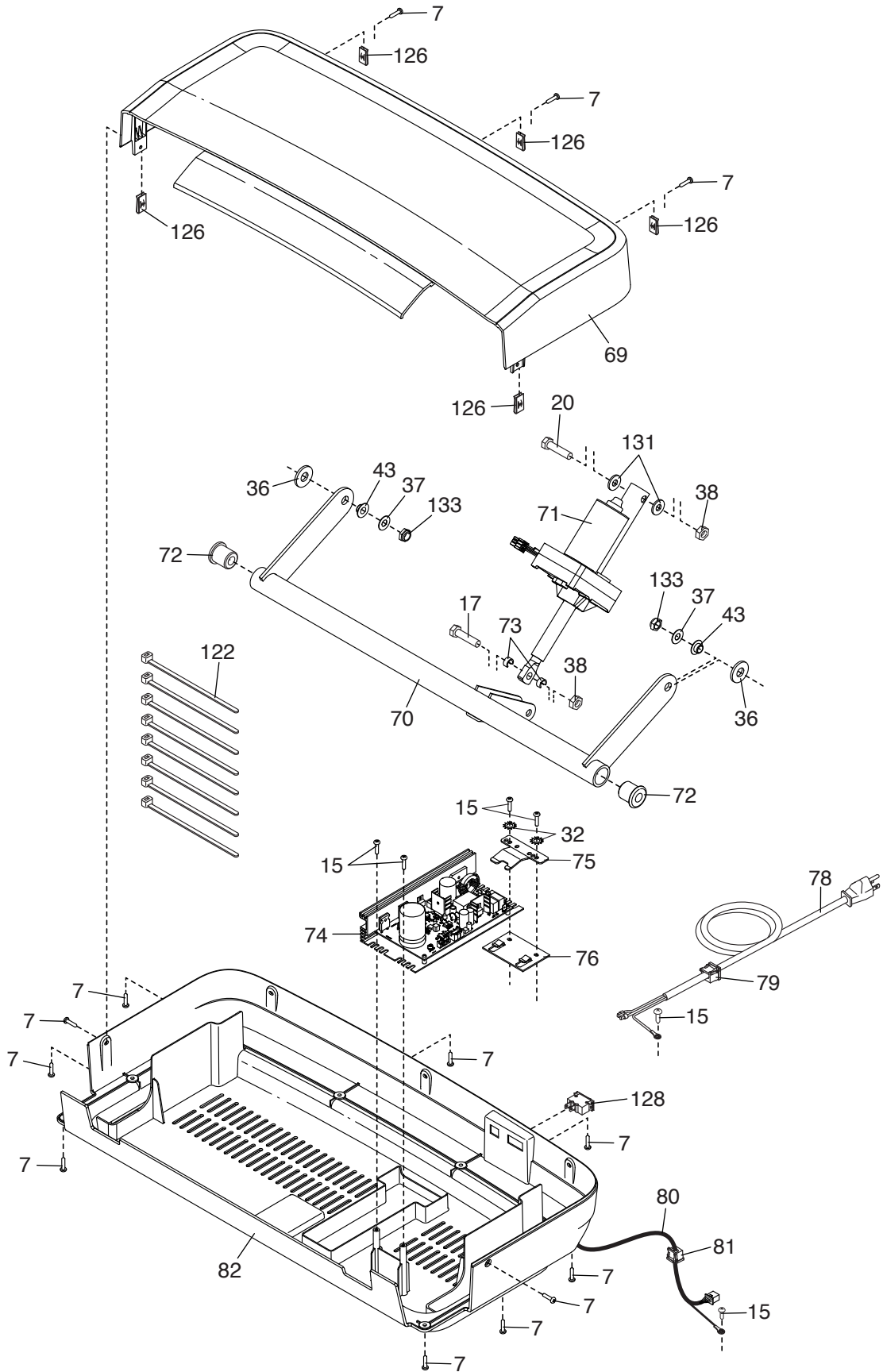

EXPLODED DRAWING C

Model No. NTL17124.3 R1122A

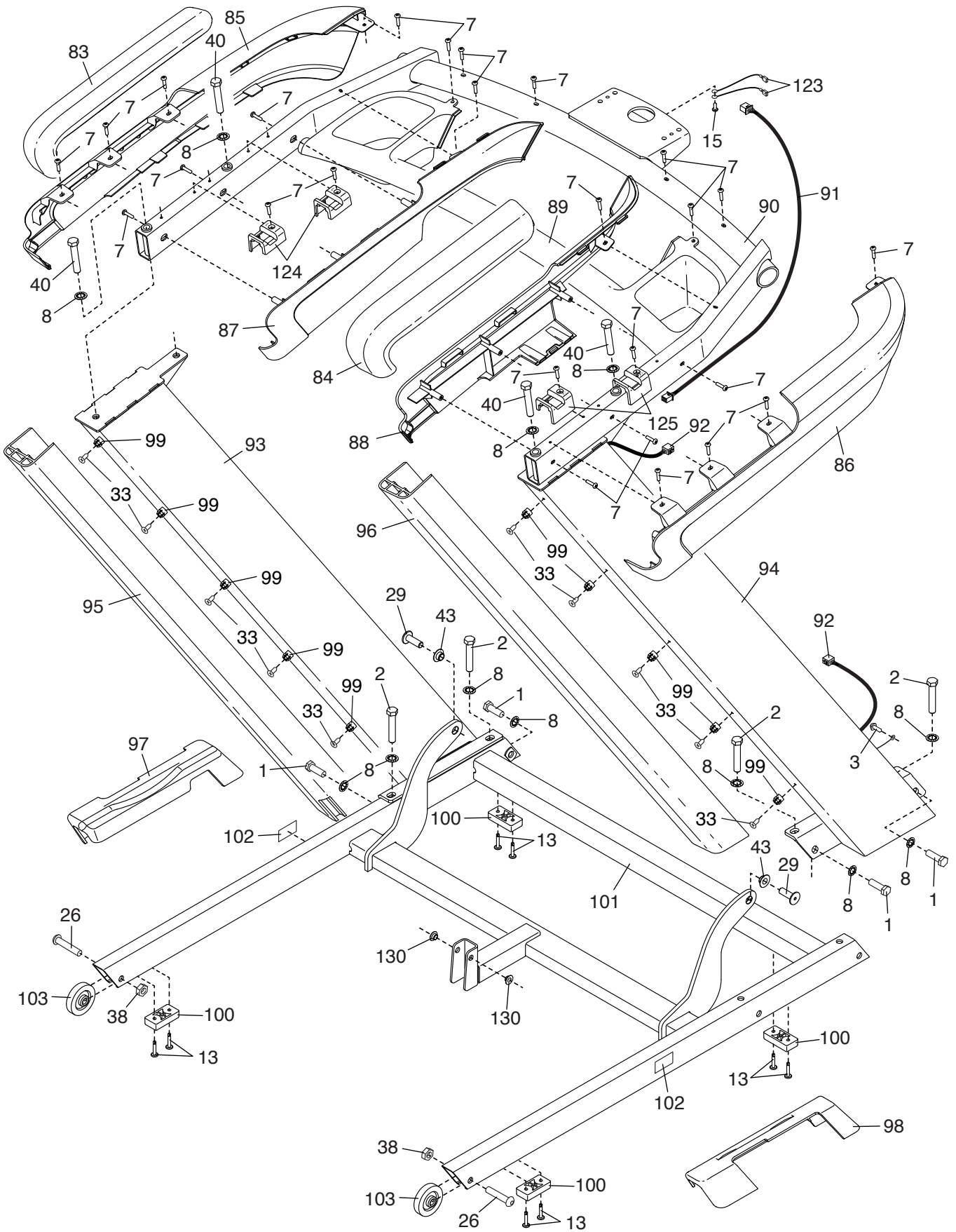

EXPLODED DRAWING D

Model No. NTL17124.3 R1122A

