

EXPLODED DRAWING A

Model No. NTL17919.3 R0419A

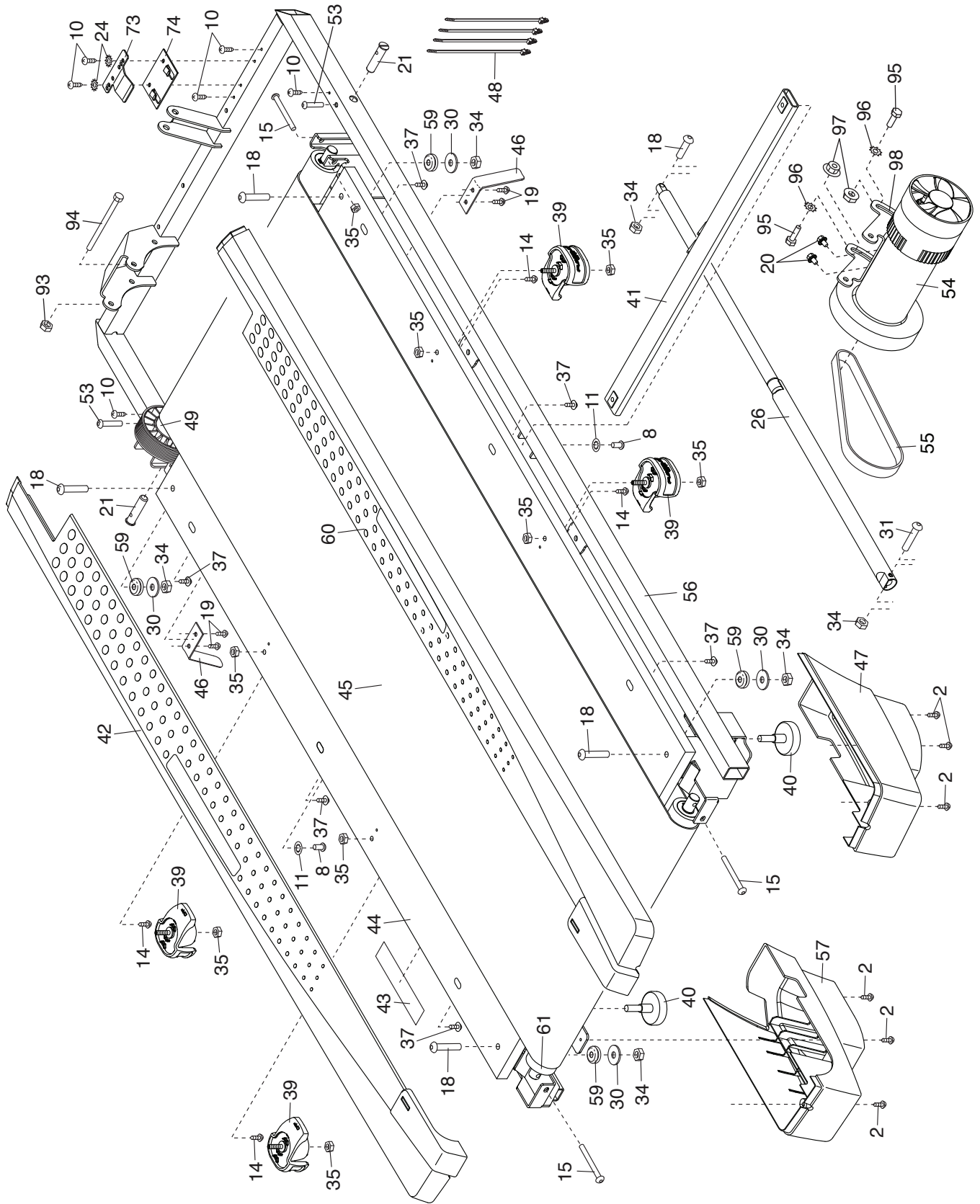

EXPLODED DRAWING B

Model No. NTL17919.3 R0419A

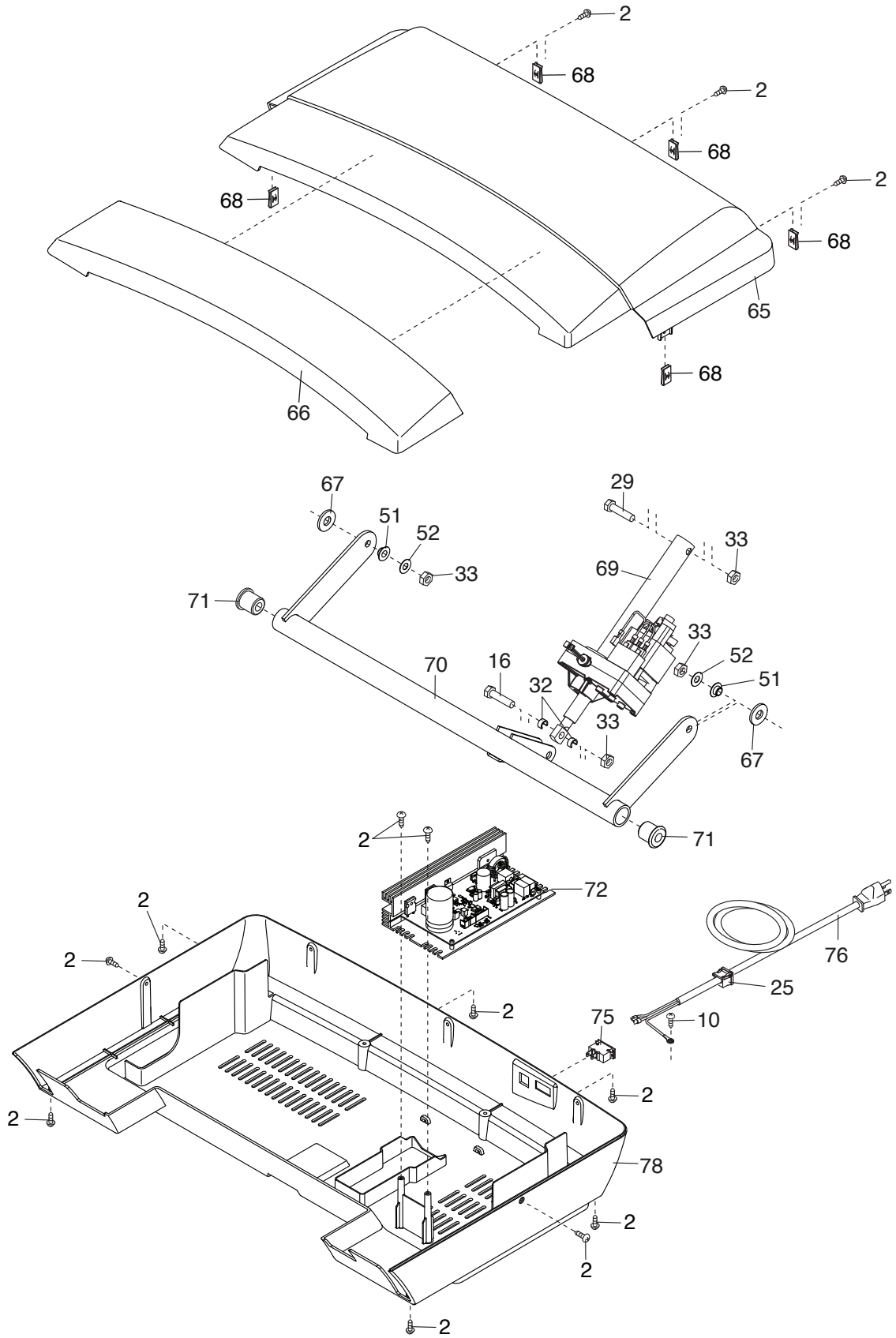

EXPLODED DRAWING C

Model No. NTL17919.3 R0419A

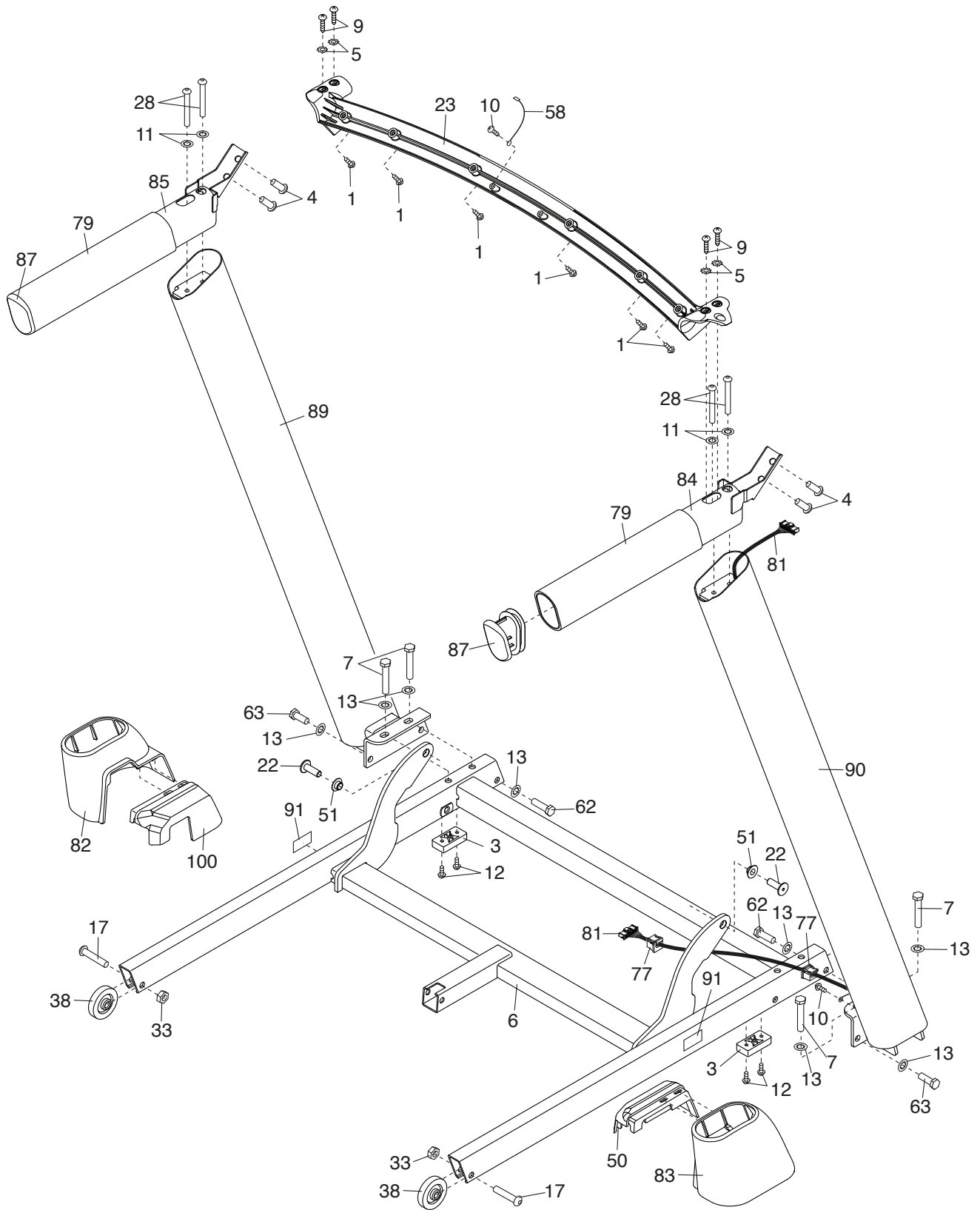

EXPLODED DRAWING D

Model No. NTL17919.3 R0419A

