

EXPLODED DRAWING A

Model No. NTL19010.3 R0812A

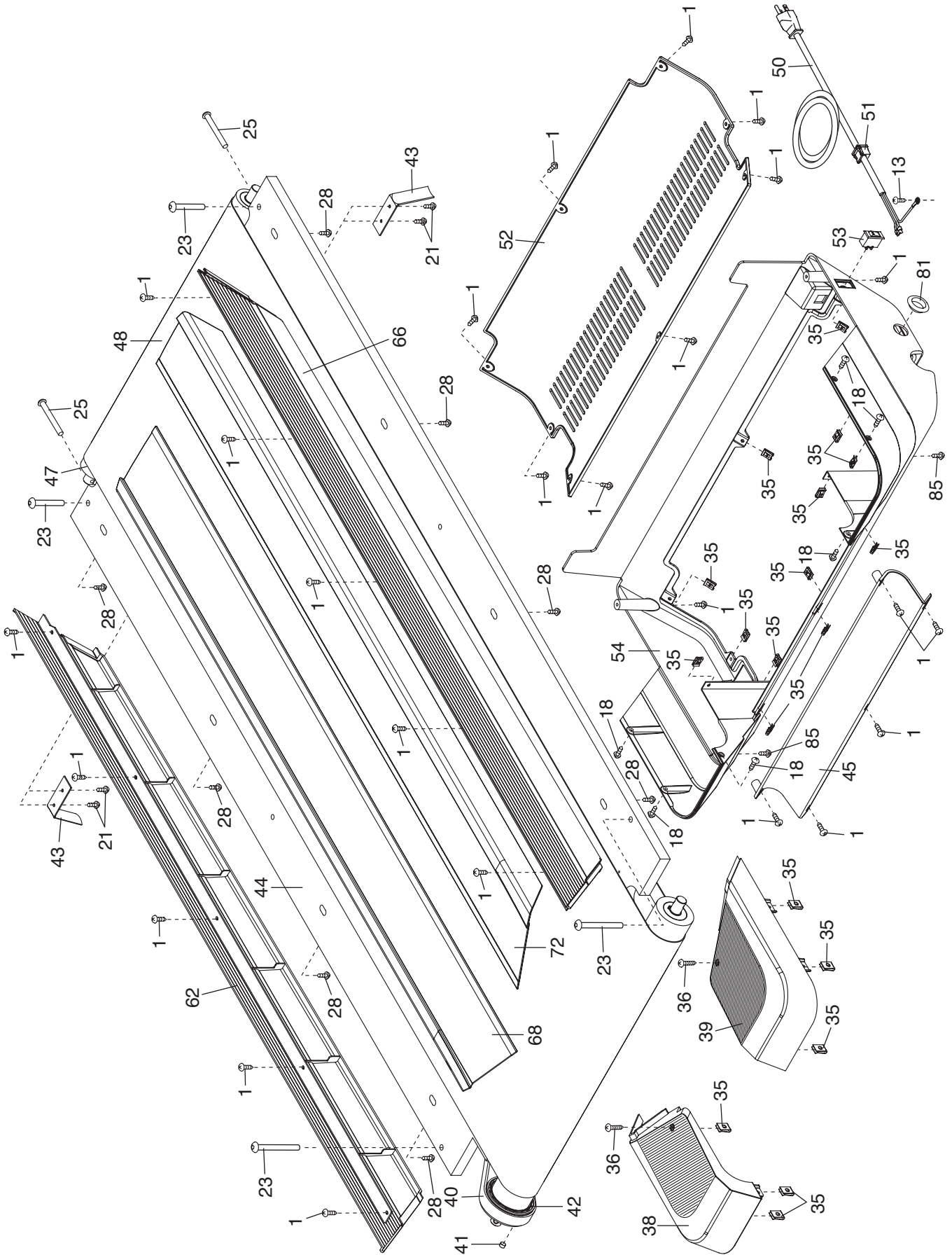

EXPLODED DRAWING B

Model No. NTL19010.3 R0812A

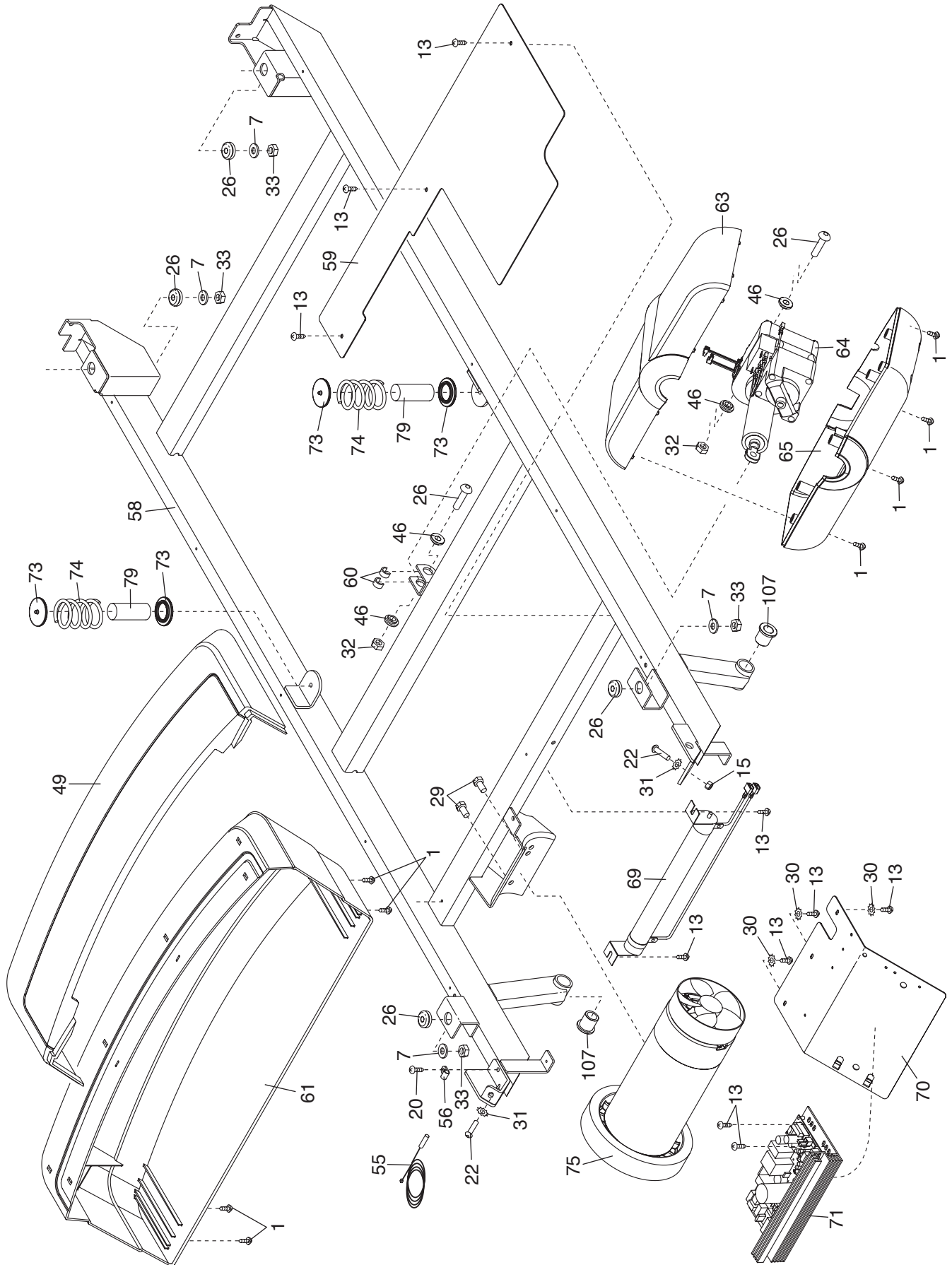

EXPLODED DRAWING C

Model No. NTL19010.3 R0812A

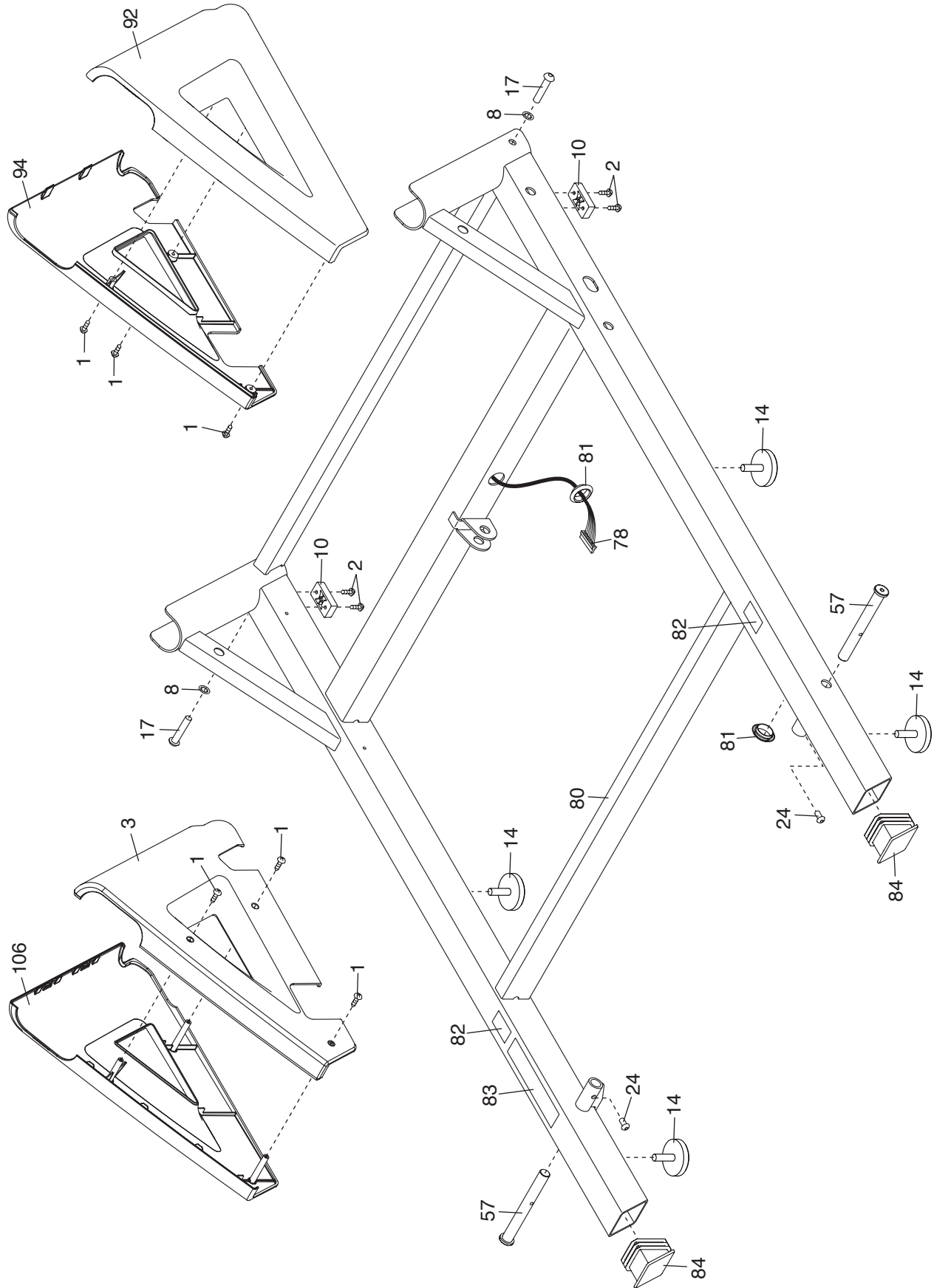

EXPLODED DRAWING D

Model No. NTL19010.3 R0812A

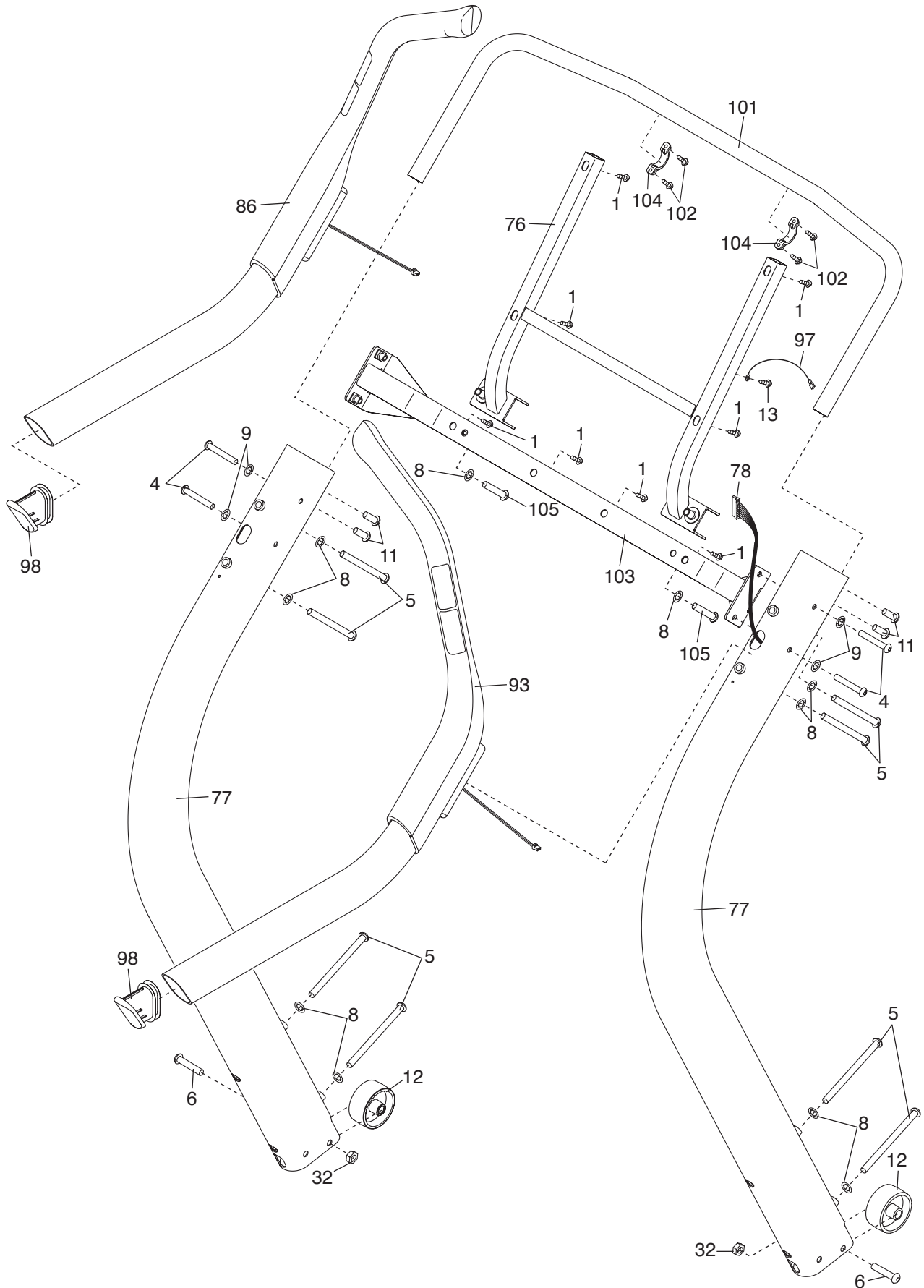

EXPLODED DRAWING E

Model No. NTL19010.3 R0812A

