

EXPLODED DRAWING A

Model No. NTL19011.0 R1211A

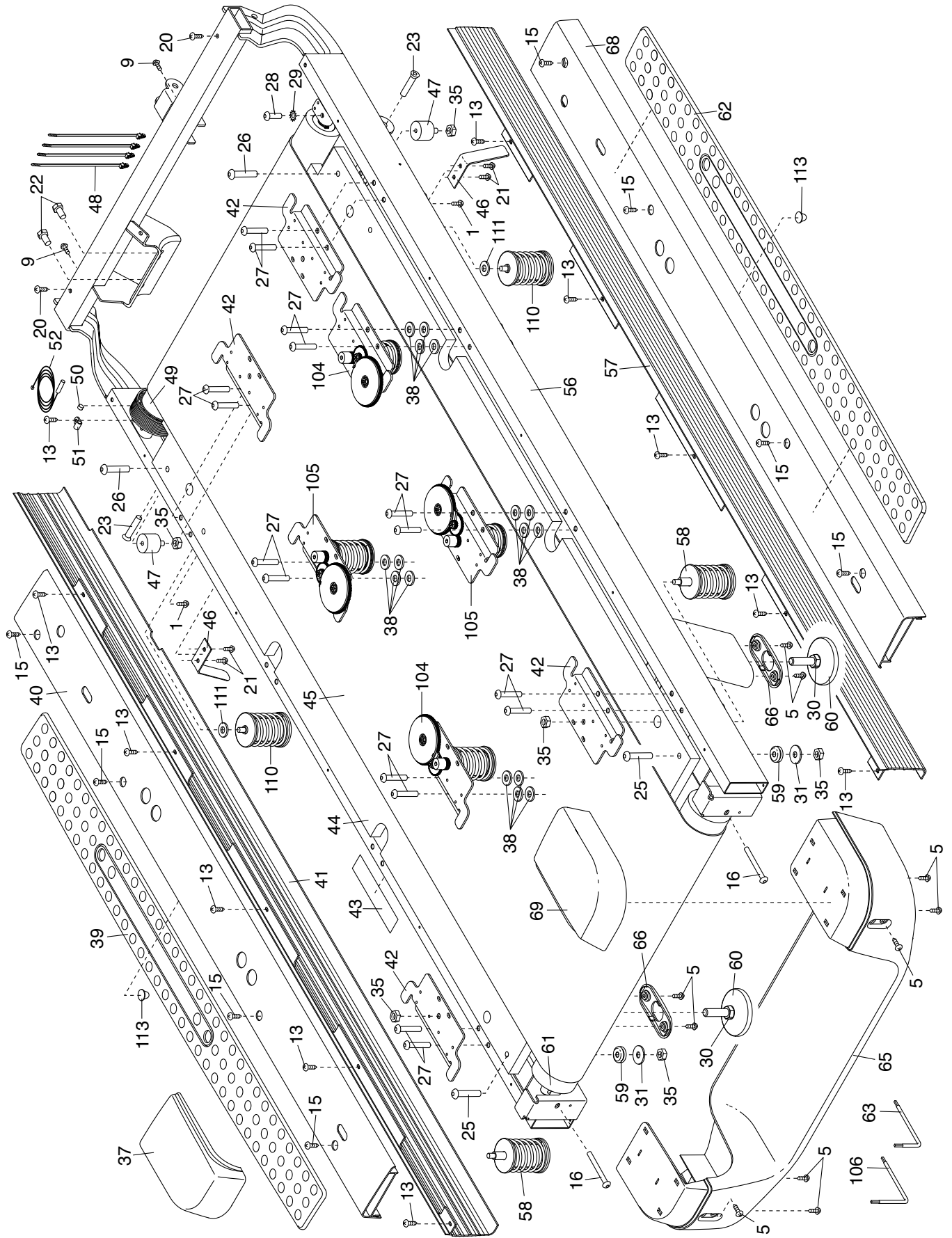

EXPLODED DRAWING B

Model No. NTL19011.0 R1211A

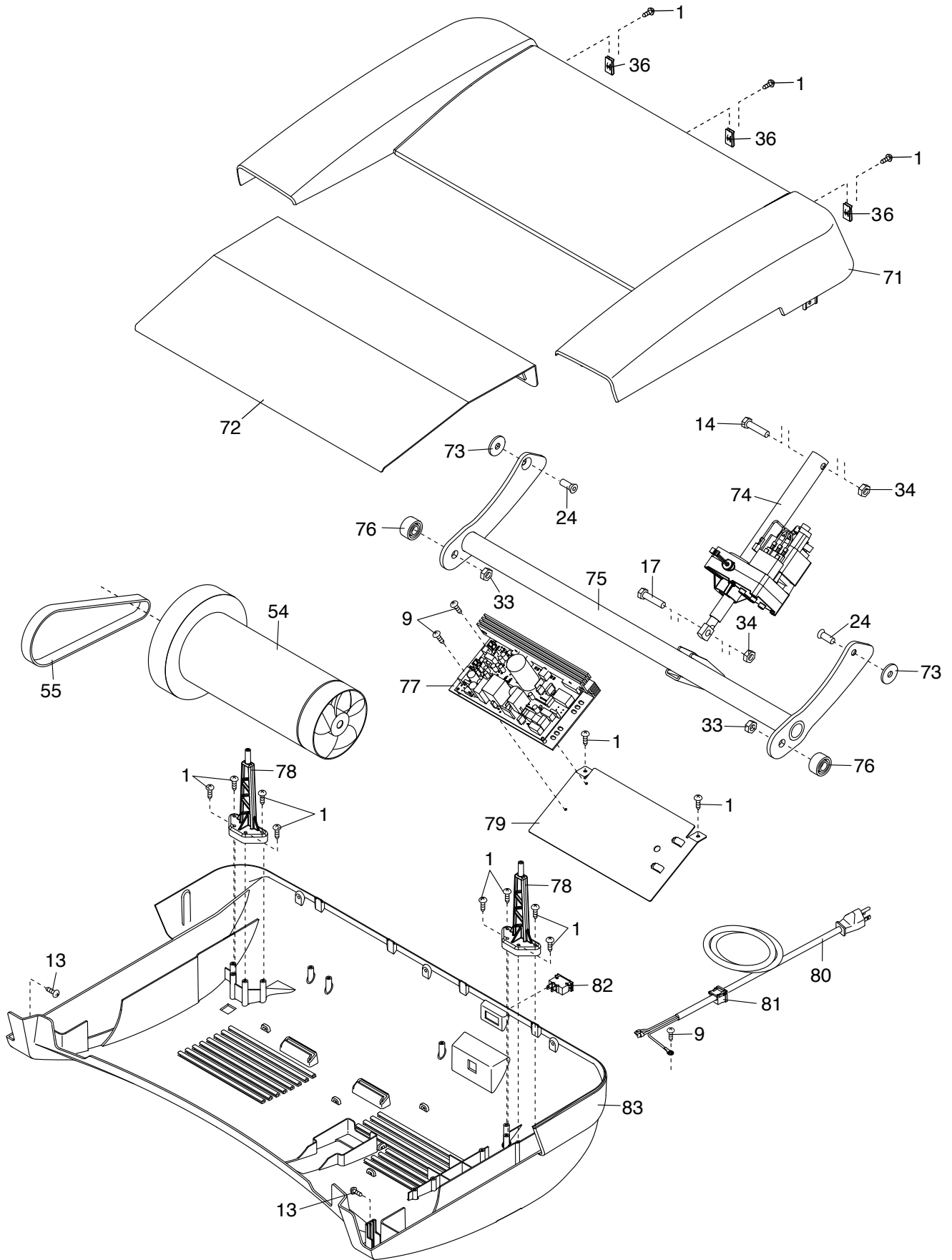

EXPLODED DRAWING C

Model No. NTL19011.0 R1211A

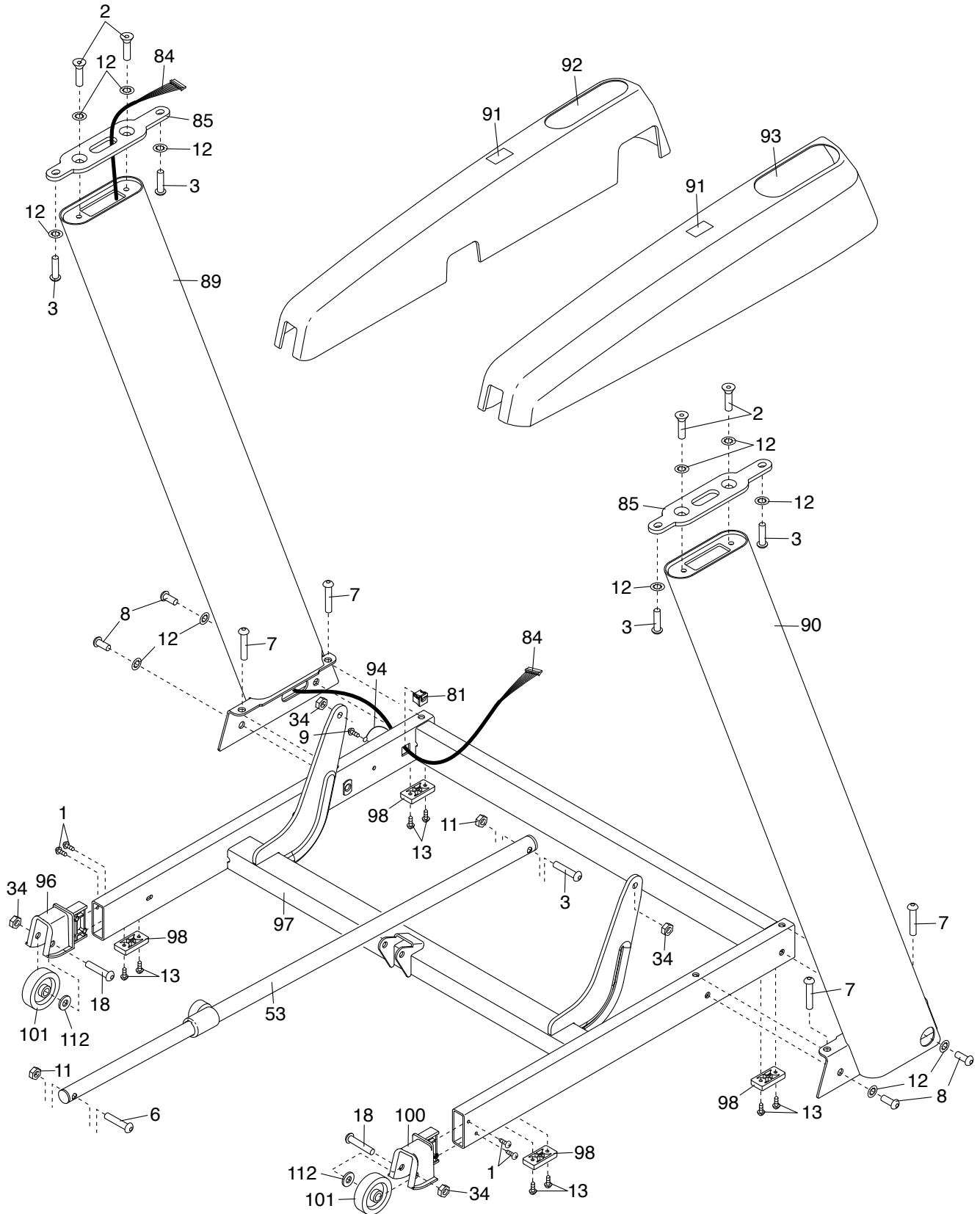

EXPLODED DRAWING D

Model No. NTL19011.0 R1211A

