

EXPLODED DRAWING A

Model No. NTL19119.4 R0219A

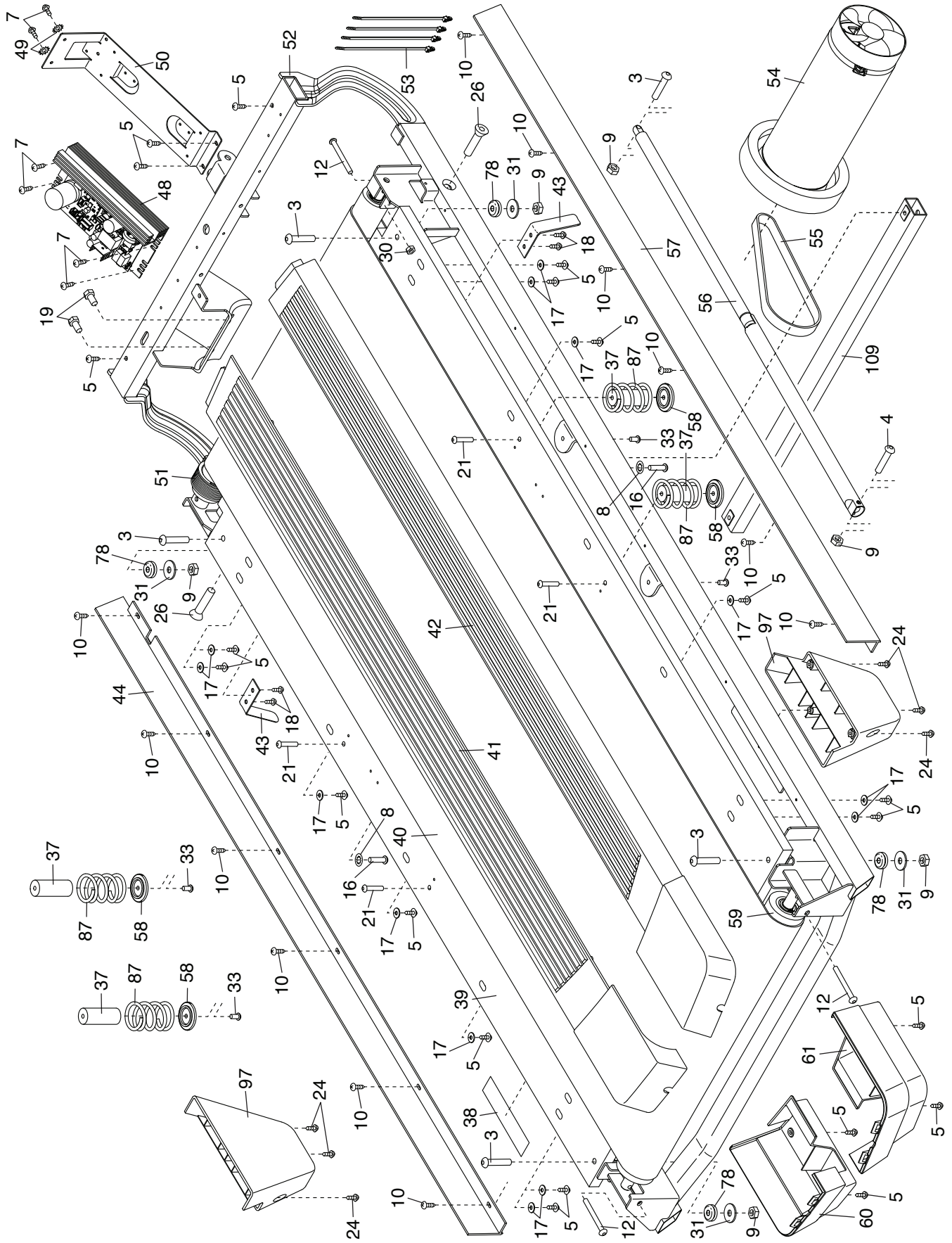

EXPLODED DRAWING B

Model No. NTL19119.4 R0219A

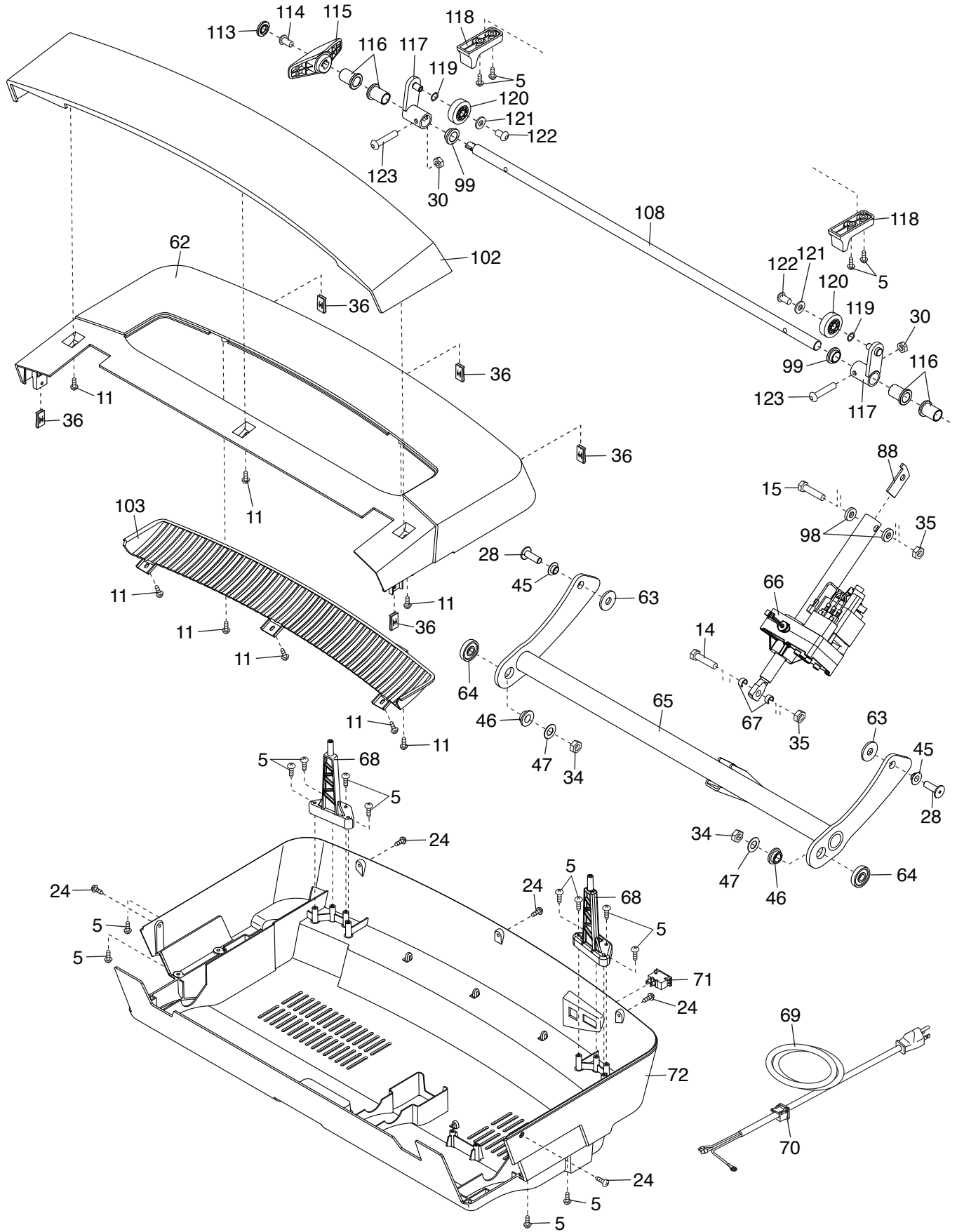

EXPLODED DRAWING C

Model No. NTL19119.4 R0219A

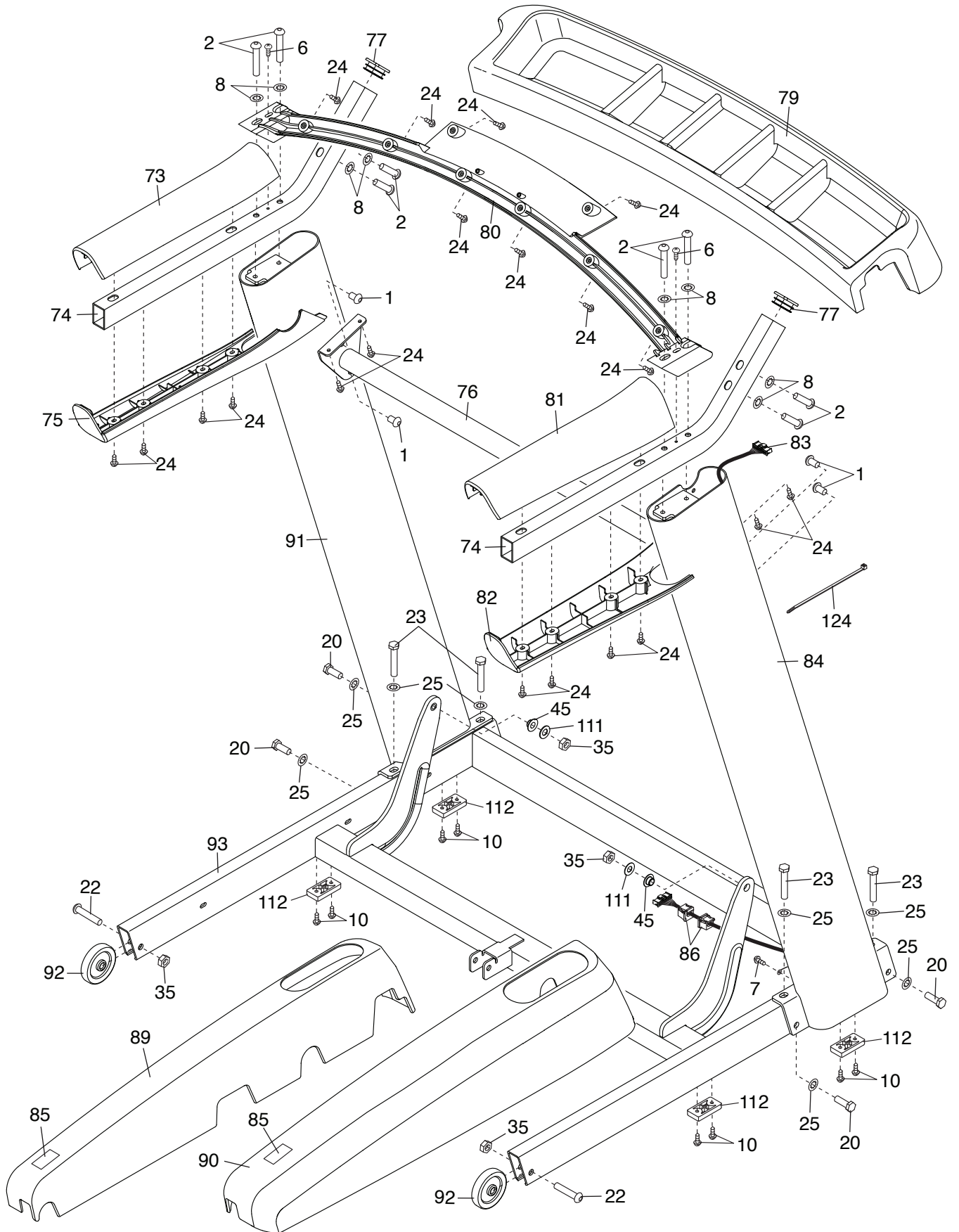

EXPLODED DRAWING D

Model No. NTL19119.4 R0219A

