

EXPLODED DRAWING A

Model No. NTL19221.0 R1220A

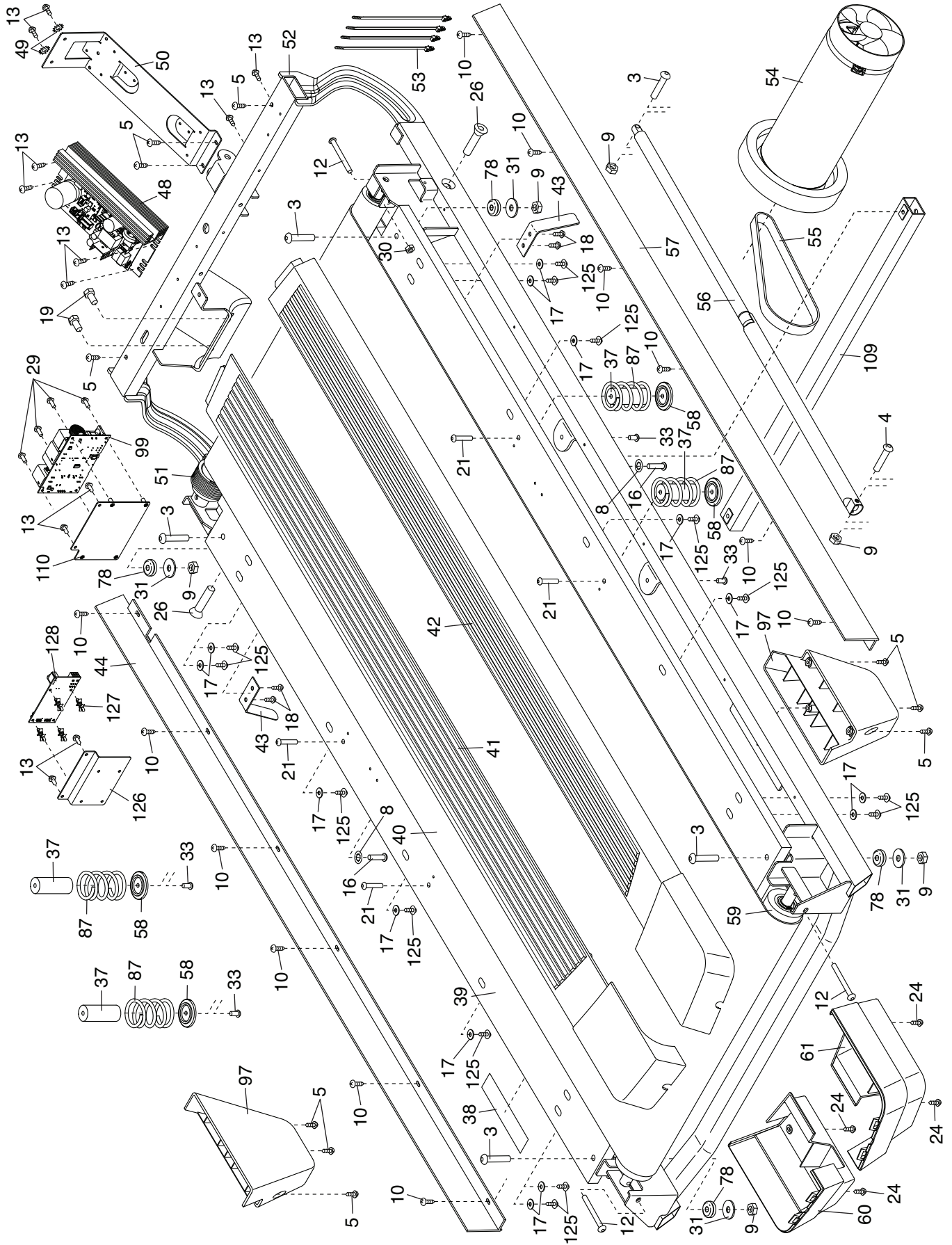

EXPLODED DRAWING B

Model No. NTL19221.0 R1220A

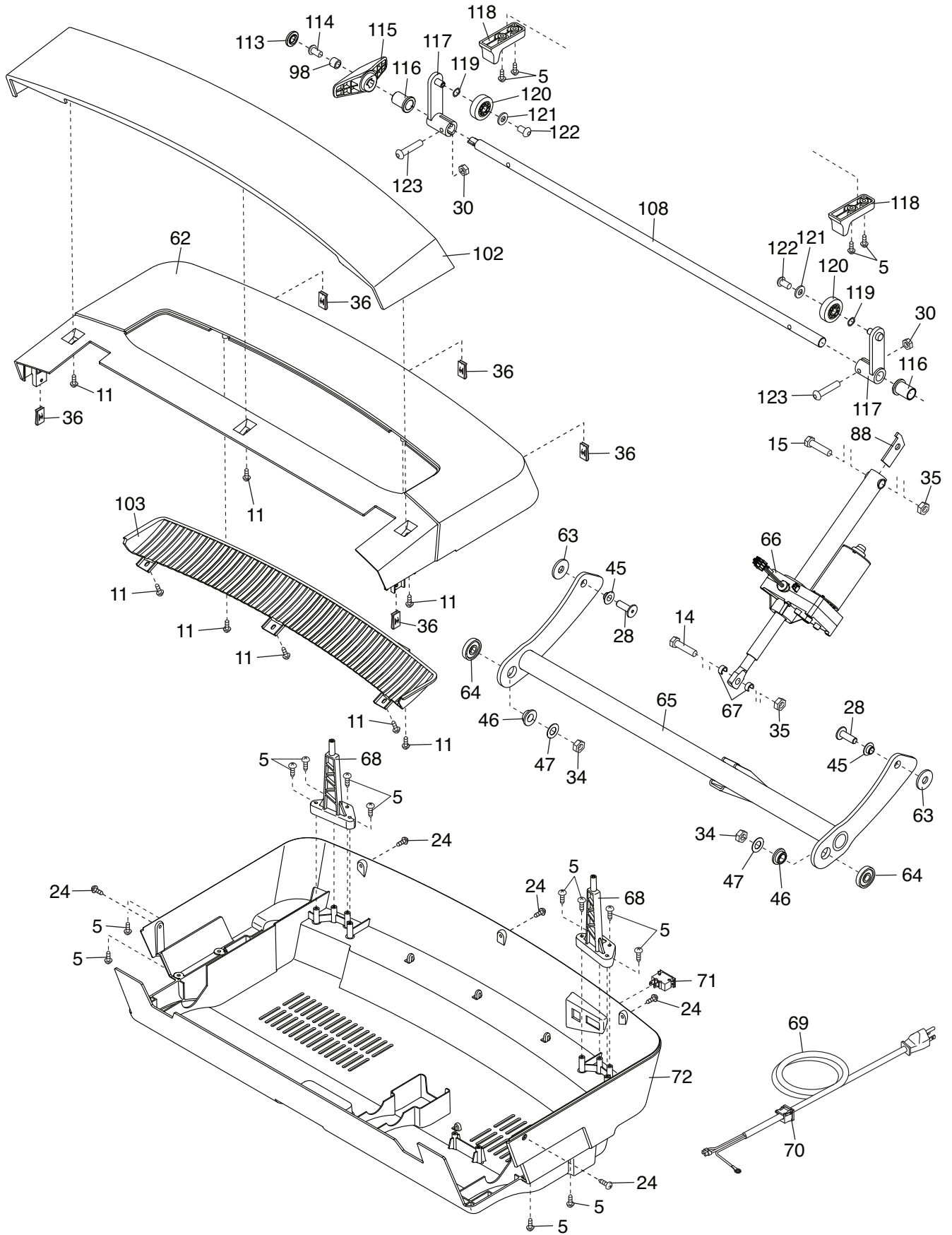

EXPLODED DRAWING C

Model No. NTL19221.0 R1220A

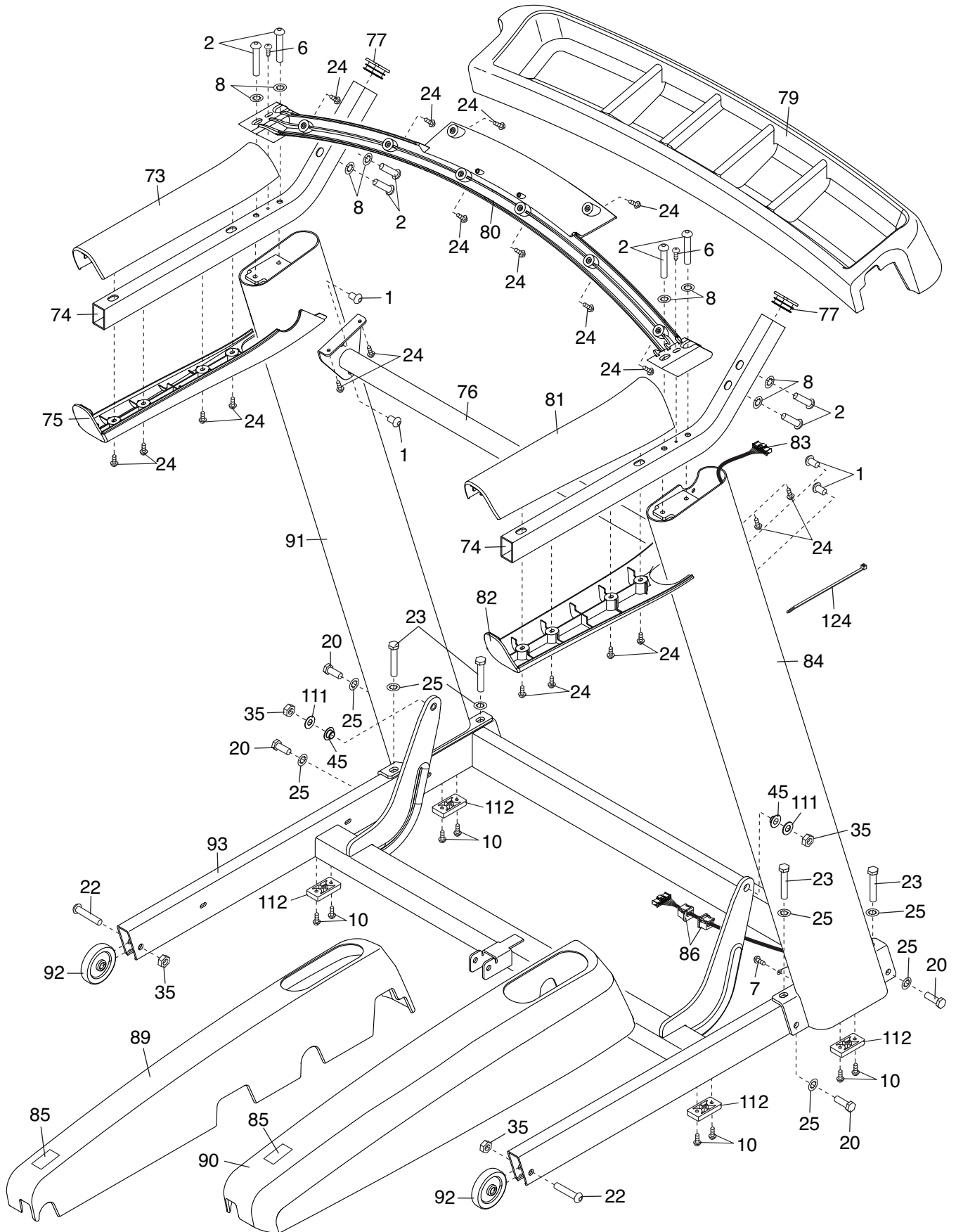

EXPLODED DRAWING D

Model No. NTL19221.0 R1220A

