

# EXPLODED DRAWING A

Model No. NTL19815.5 R1117A

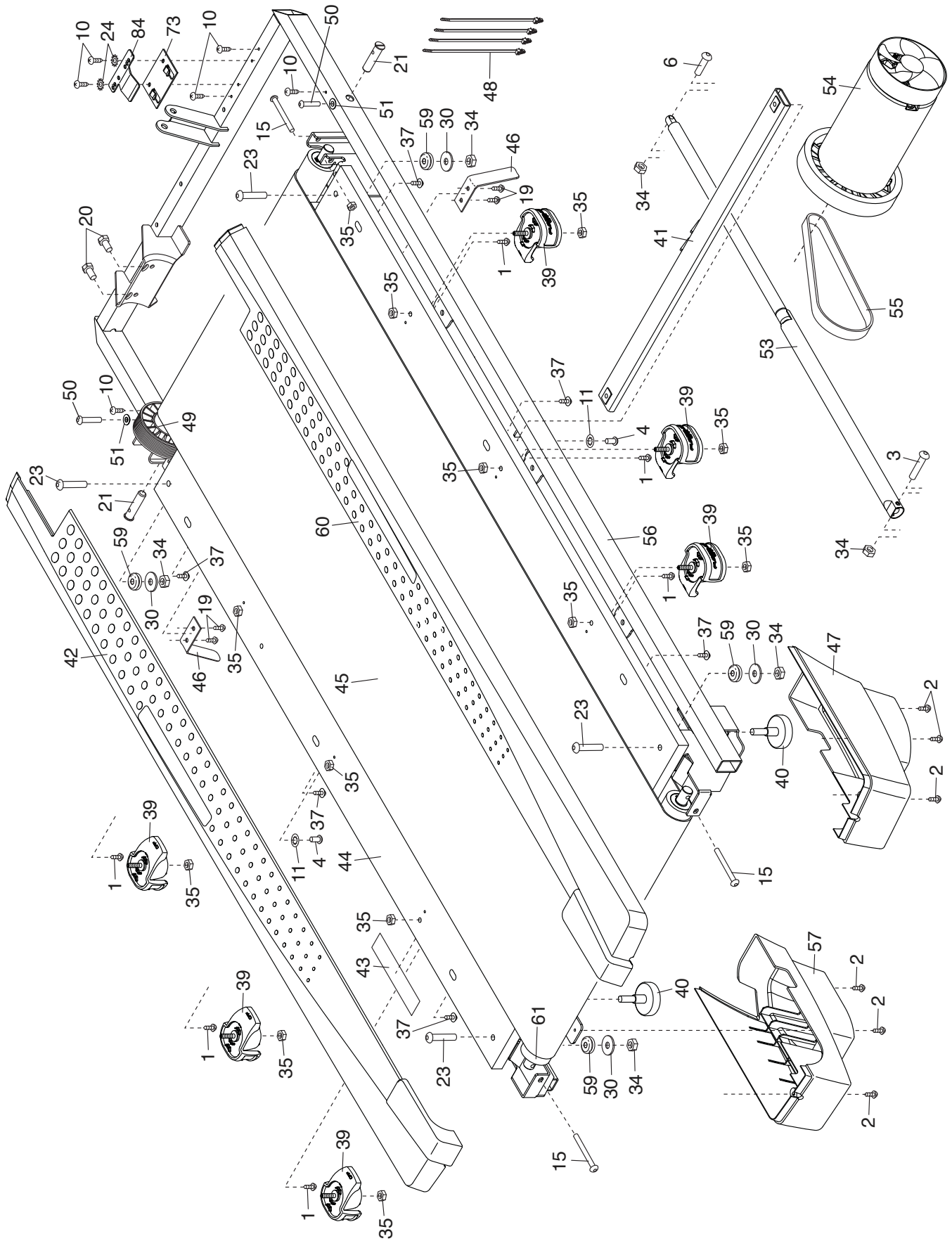

# EXPLODED DRAWING B

Model No. NTL19815.5 R1117A

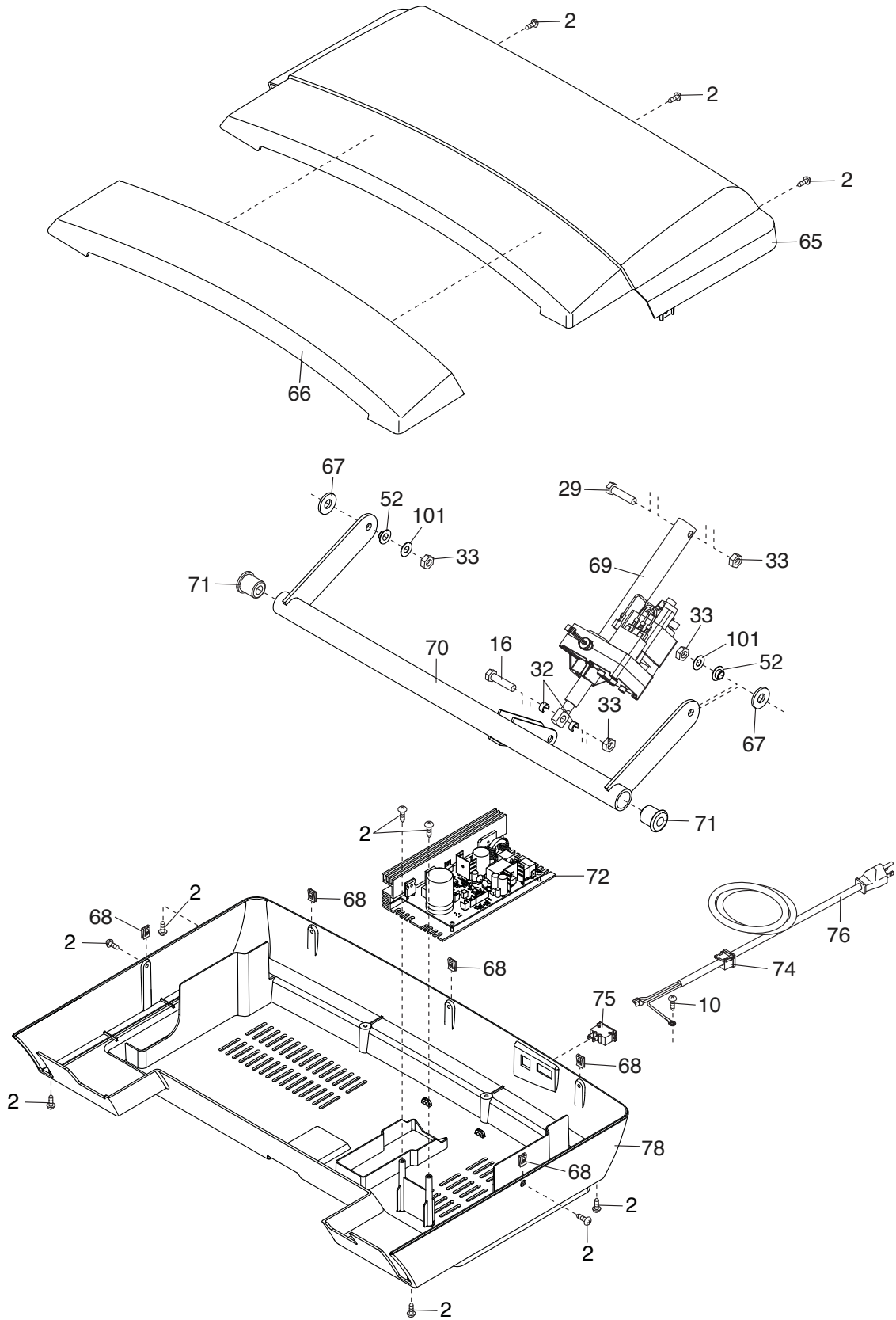

# EXPLODED DRAWING C

Model No. NTL19815.5 R1117A

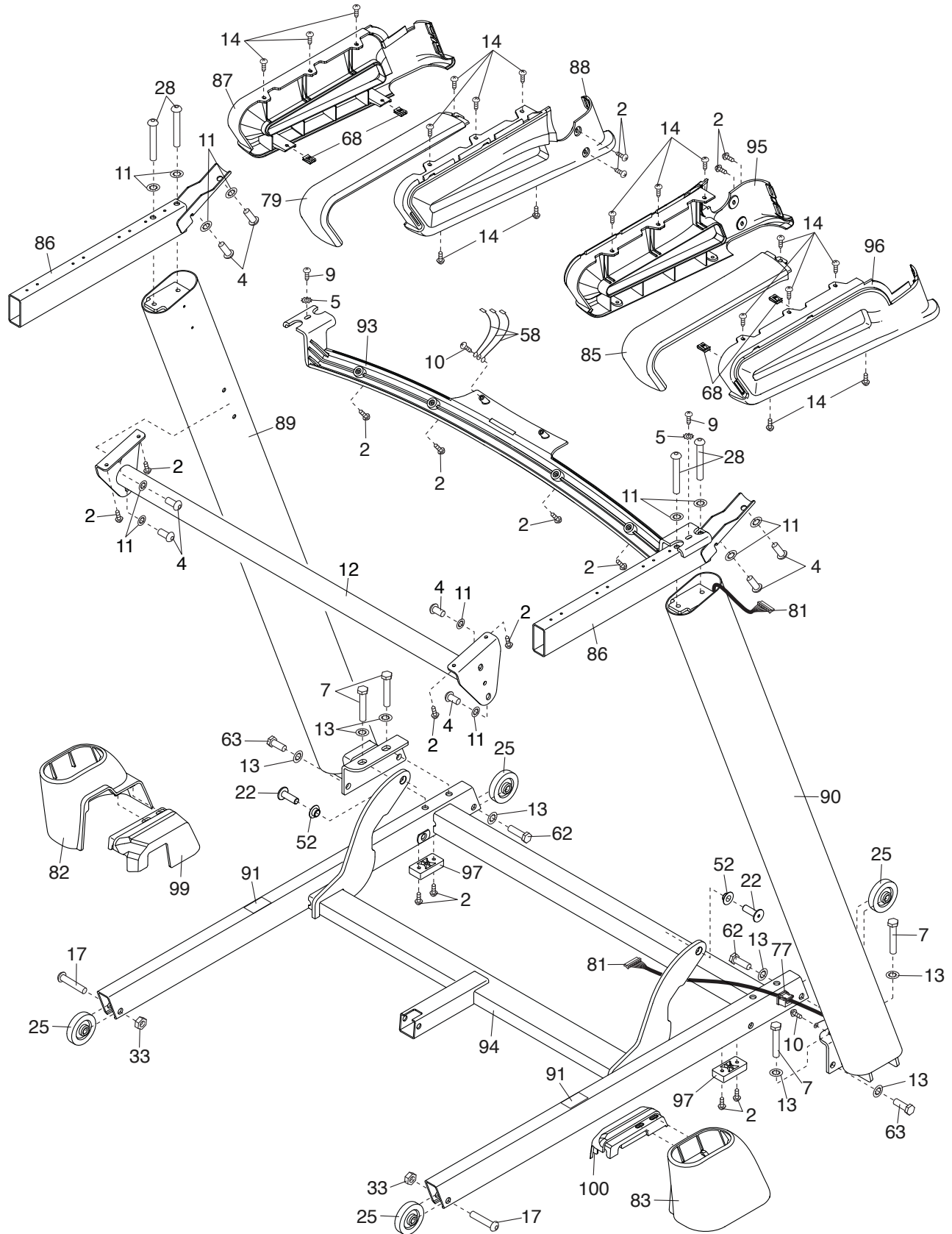

# EXPLODED DRAWING D

Model No. NTL19815.5 R1117A

