

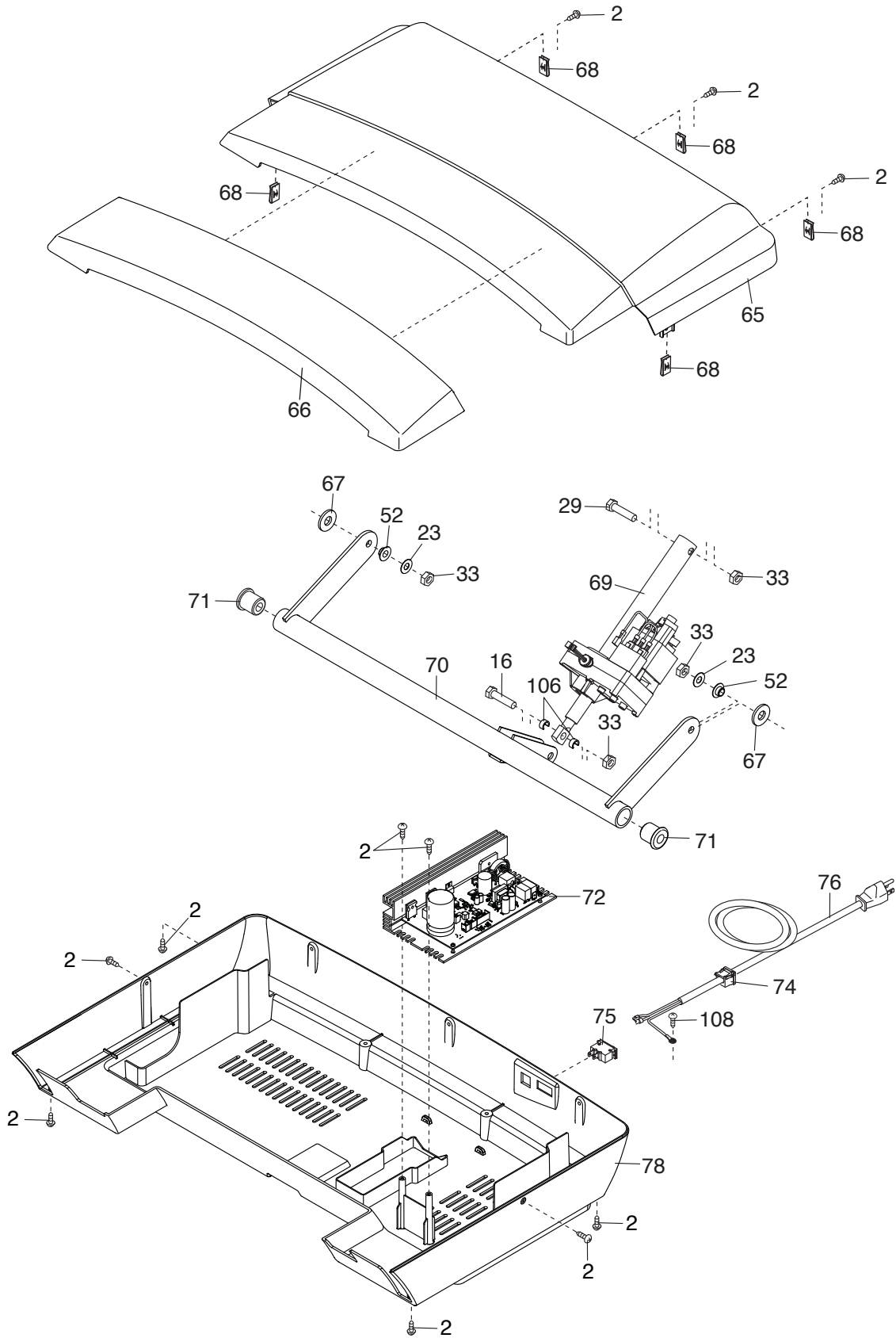

# EXPLODED DRAWING B

Model No. NTL19819.1 R1218A



# EXPLODED DRAWING C

Model No. NTL19819.1 R1218A

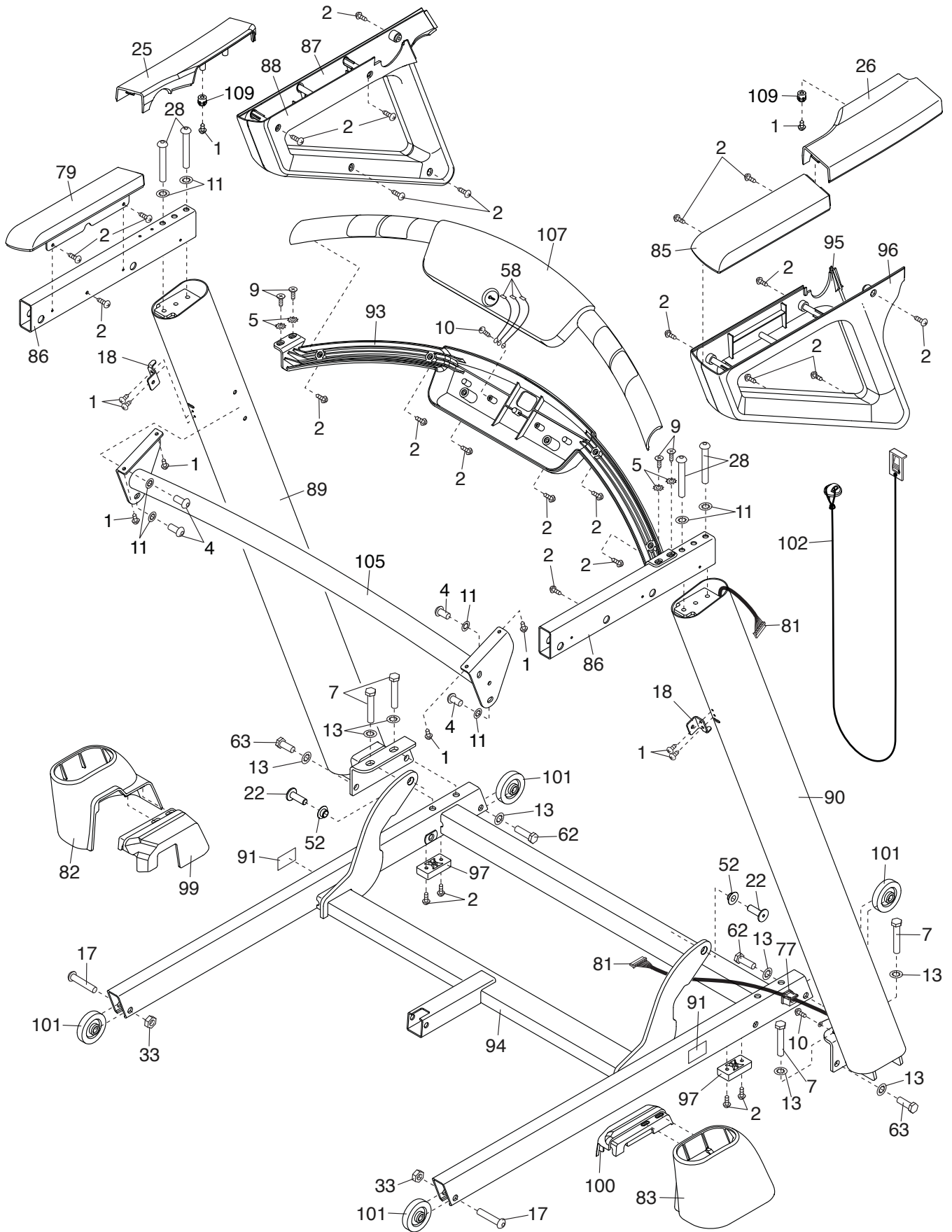

# EXPLODED DRAWING D

Model No. NTL19819.1 R1218A

