

# EXPLODED DRAWING—Model No. NTL19922

R0404A

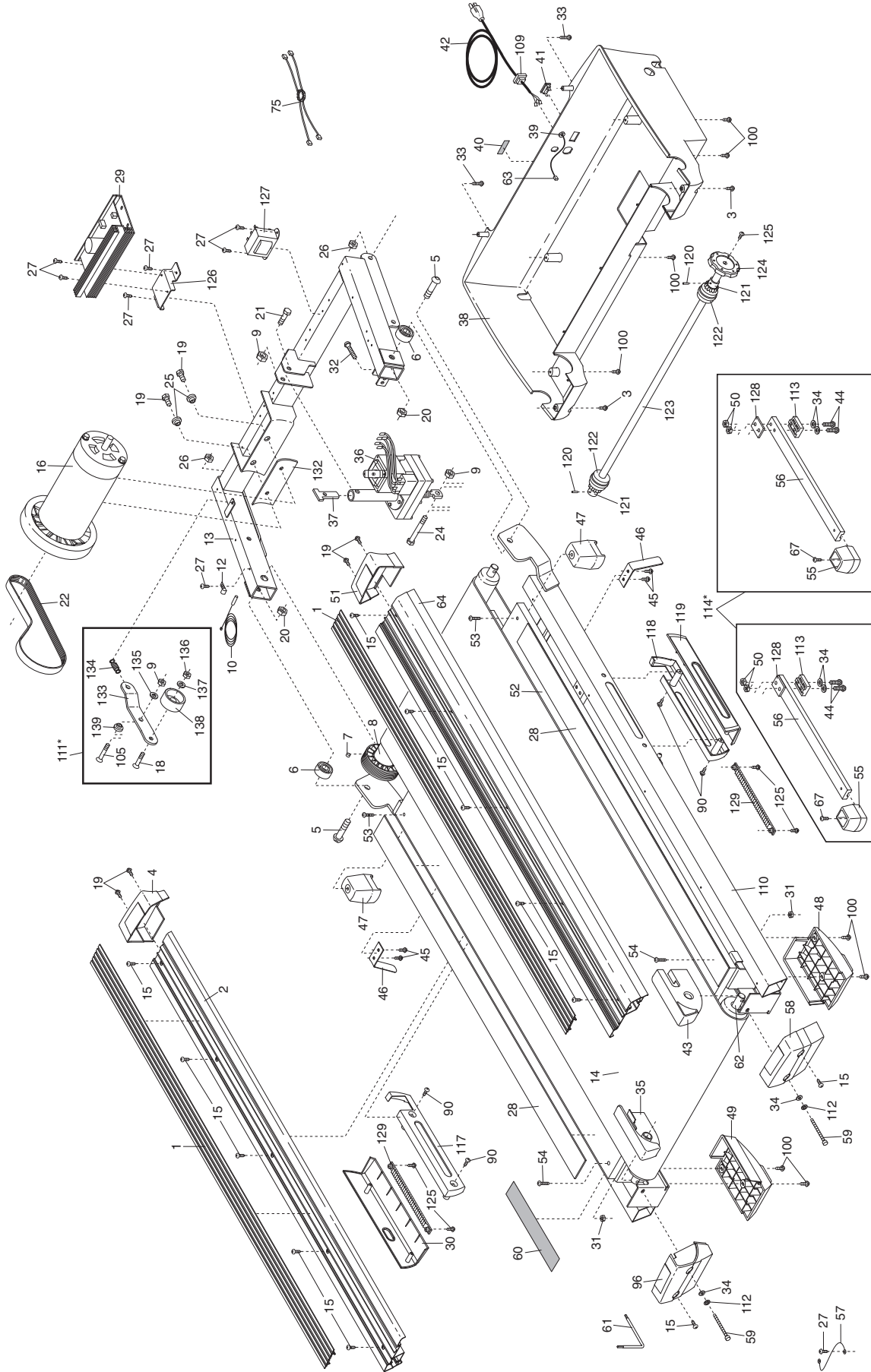

# EXPLODED DRAWING—Model No. NTL19922

R0404A

