

# EXPLODED DRAWING A

Model No. NTL22011.2 R0113A

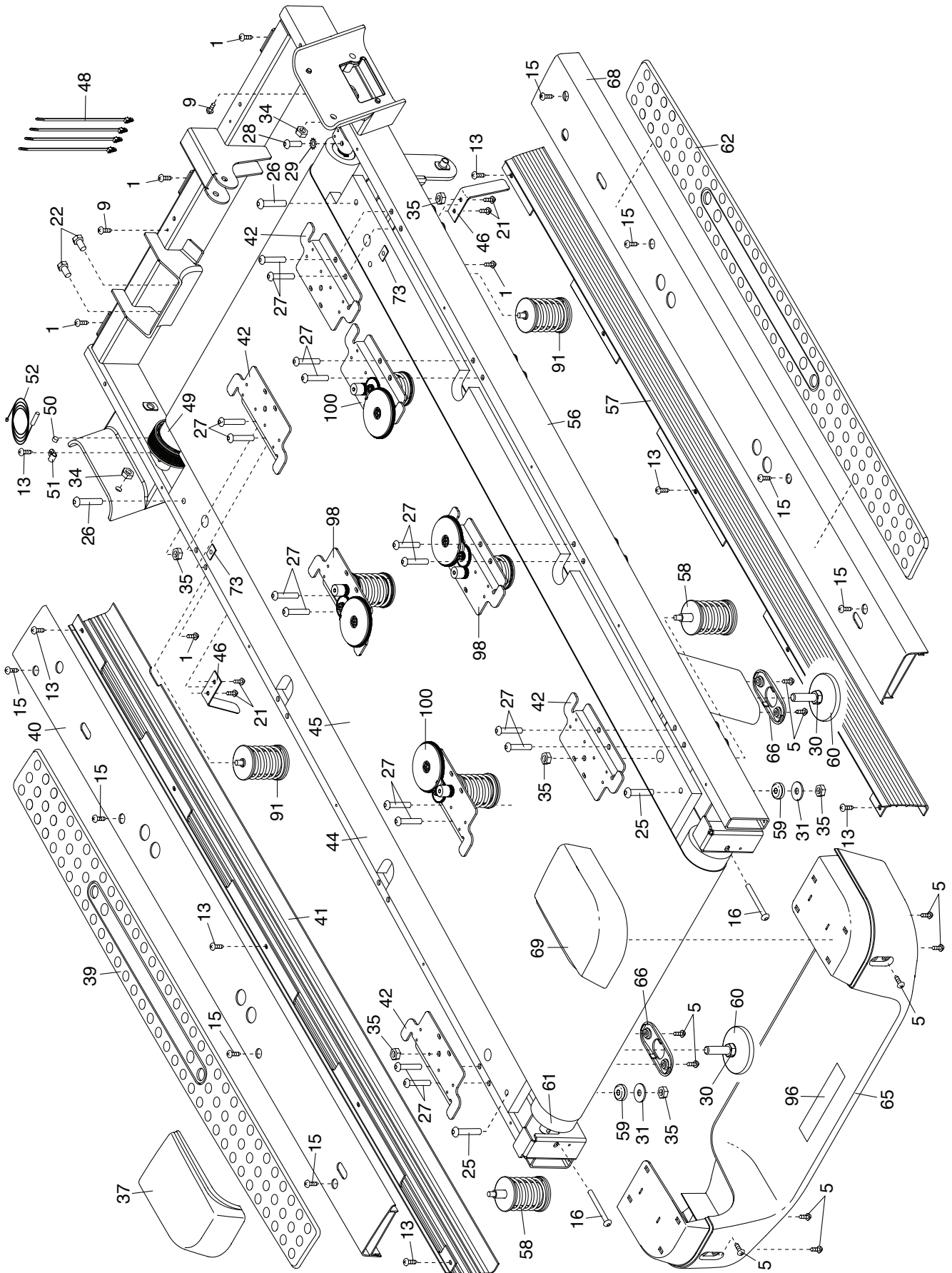

# EXPLODED DRAWING B

Model No. NTL22011.2 R0113A

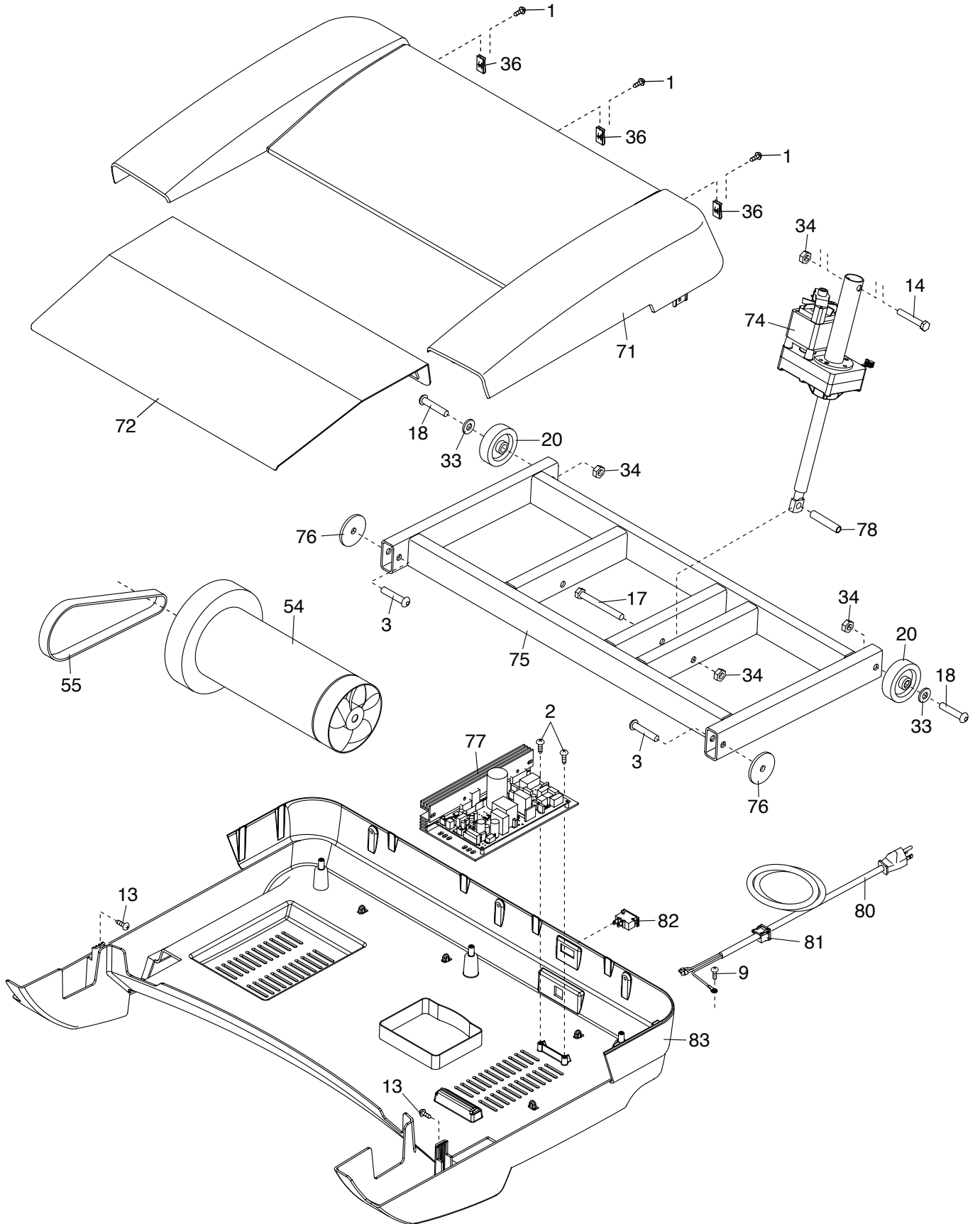

# EXPLODED DRAWING C

Model No. NTL22011.2 R0113A

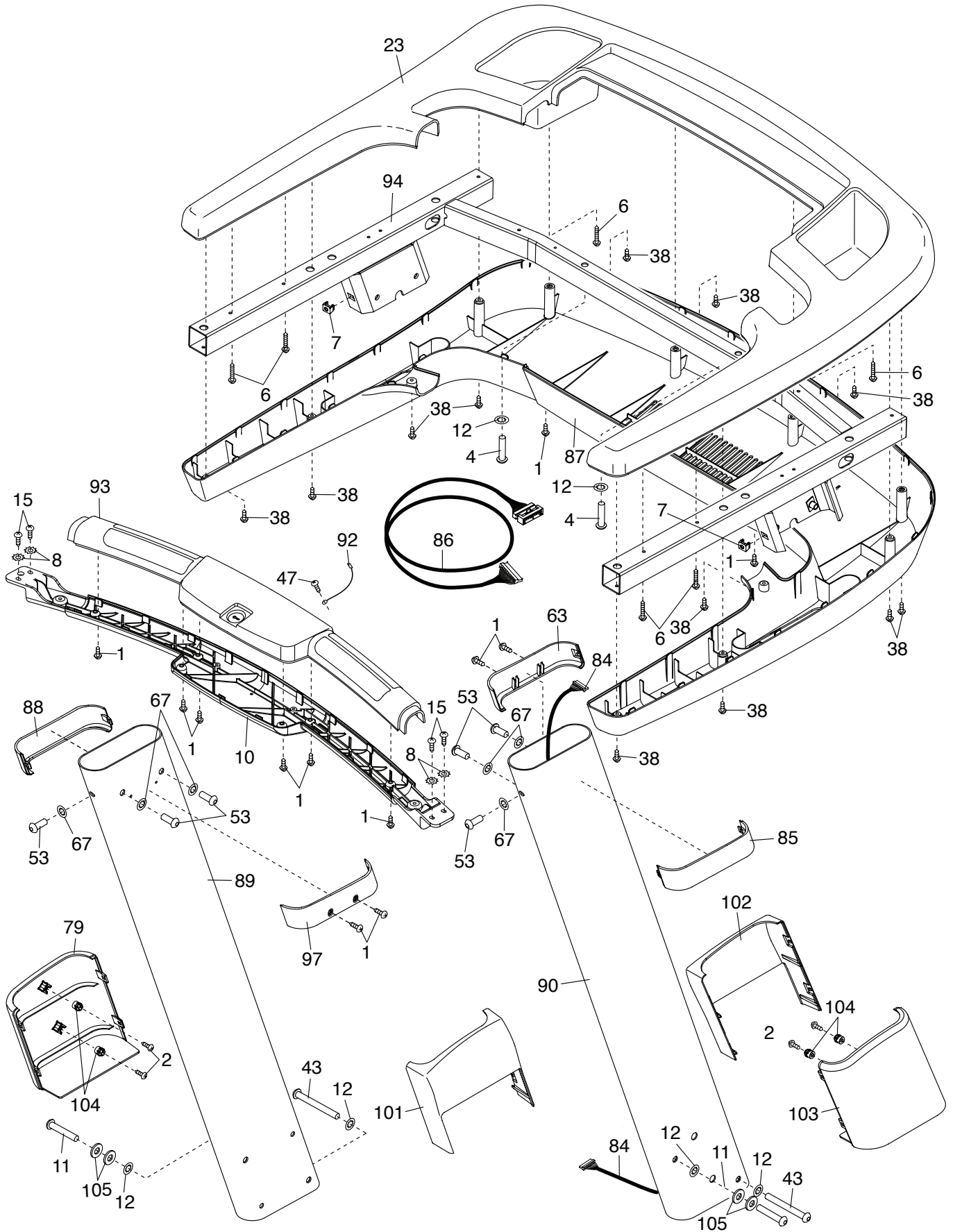

# EXPLODED DRAWING D

Model No. NTL22011.2 R0113A

