

EXPLODED DRAWING A

Model No. NTL22019.0 R1218A

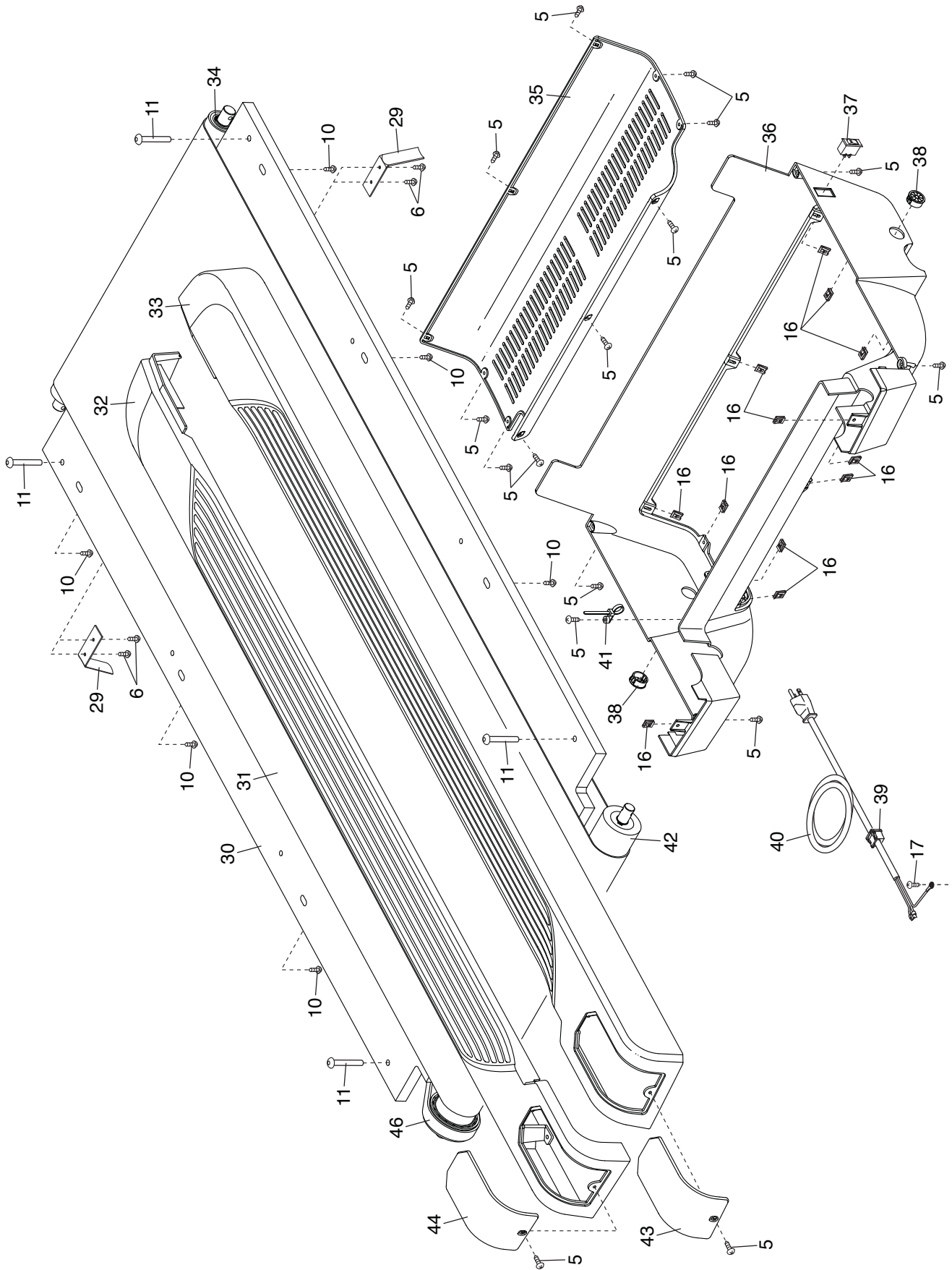

EXPLODED DRAWING B

Model No. NTL22019.0 R1218A

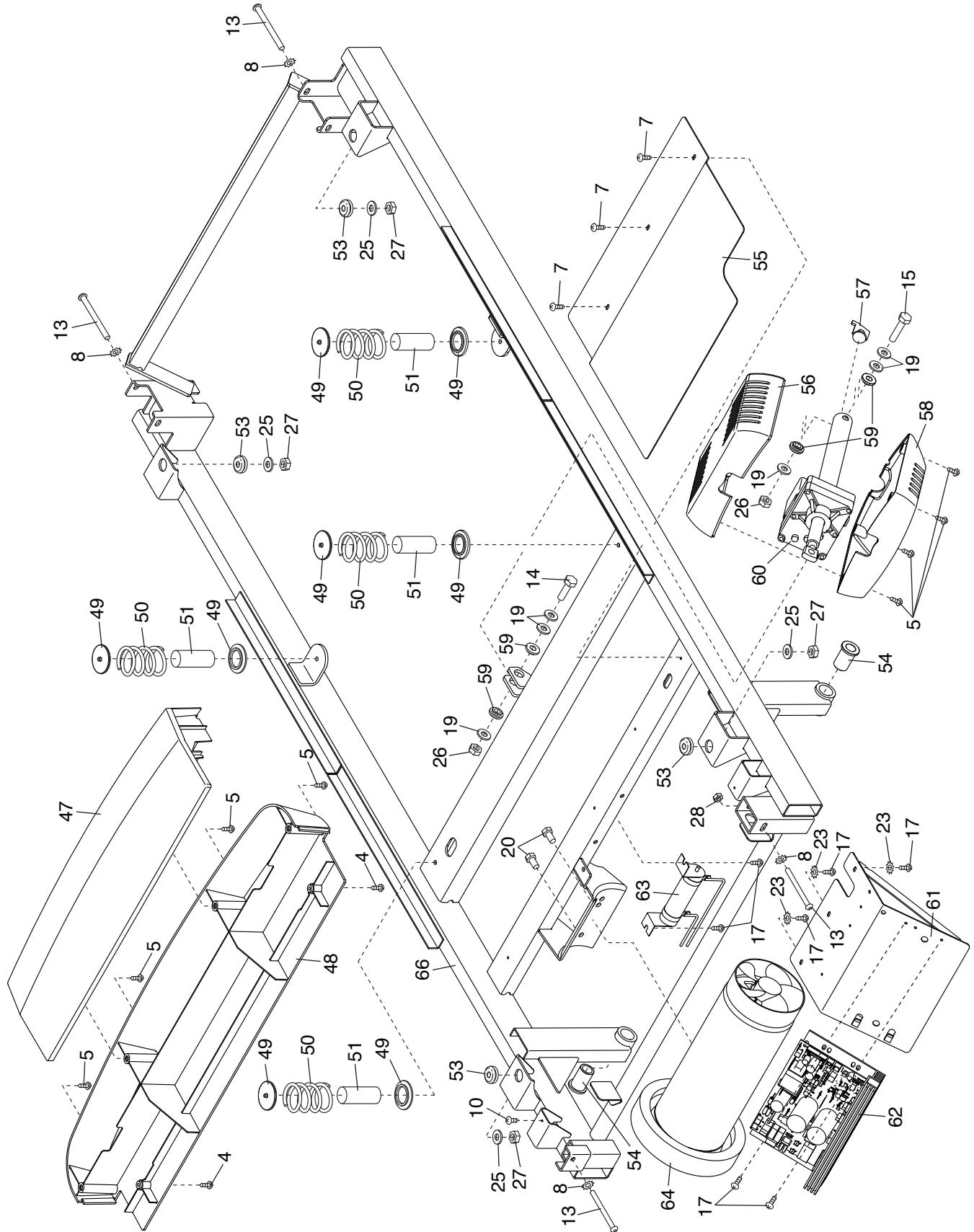

EXPLODED DRAWING C

Model No. NTL22019.0 R1218A

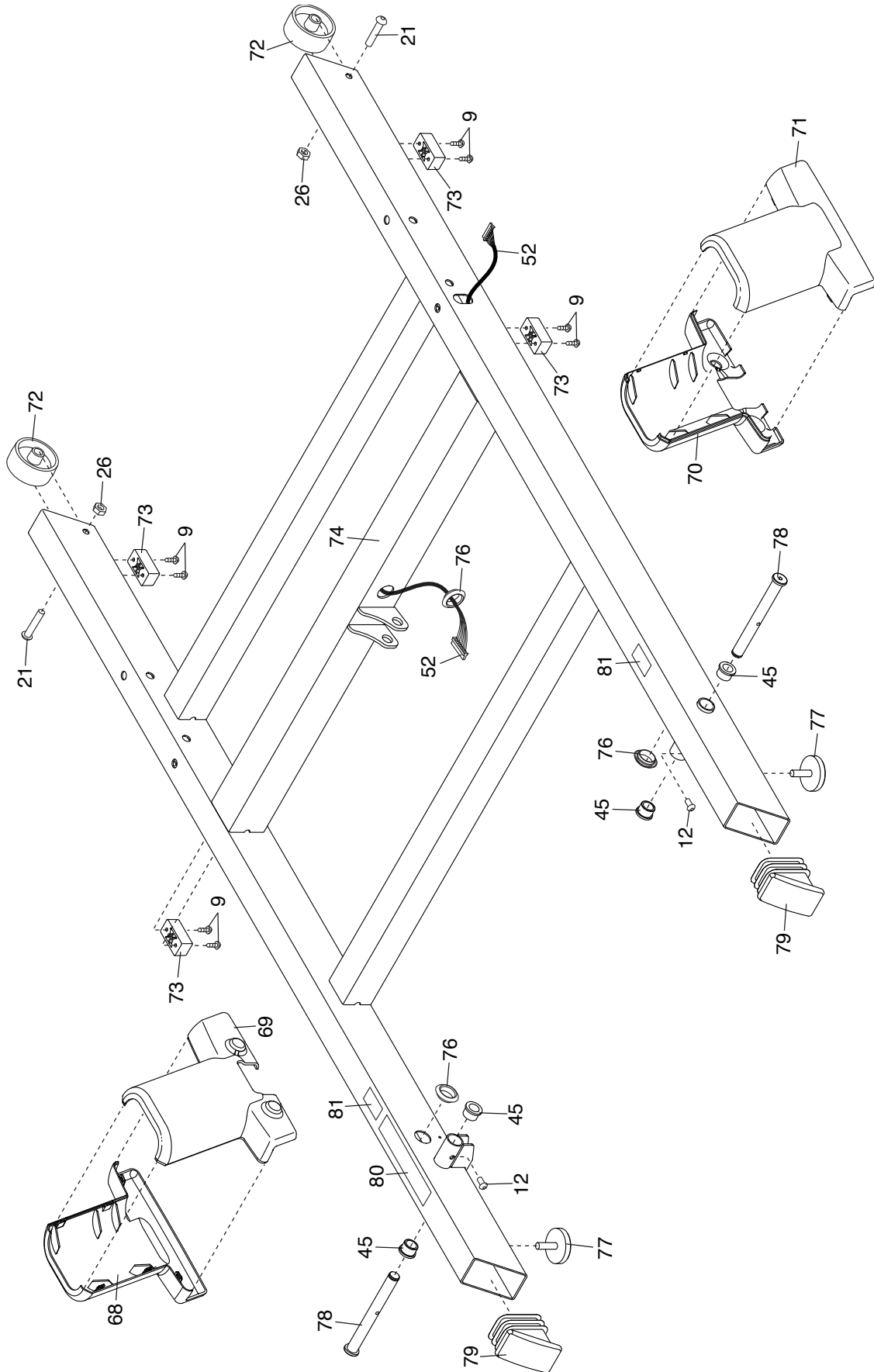

EXPLODED DRAWING D

Model No. NTL22019.0 R1218A

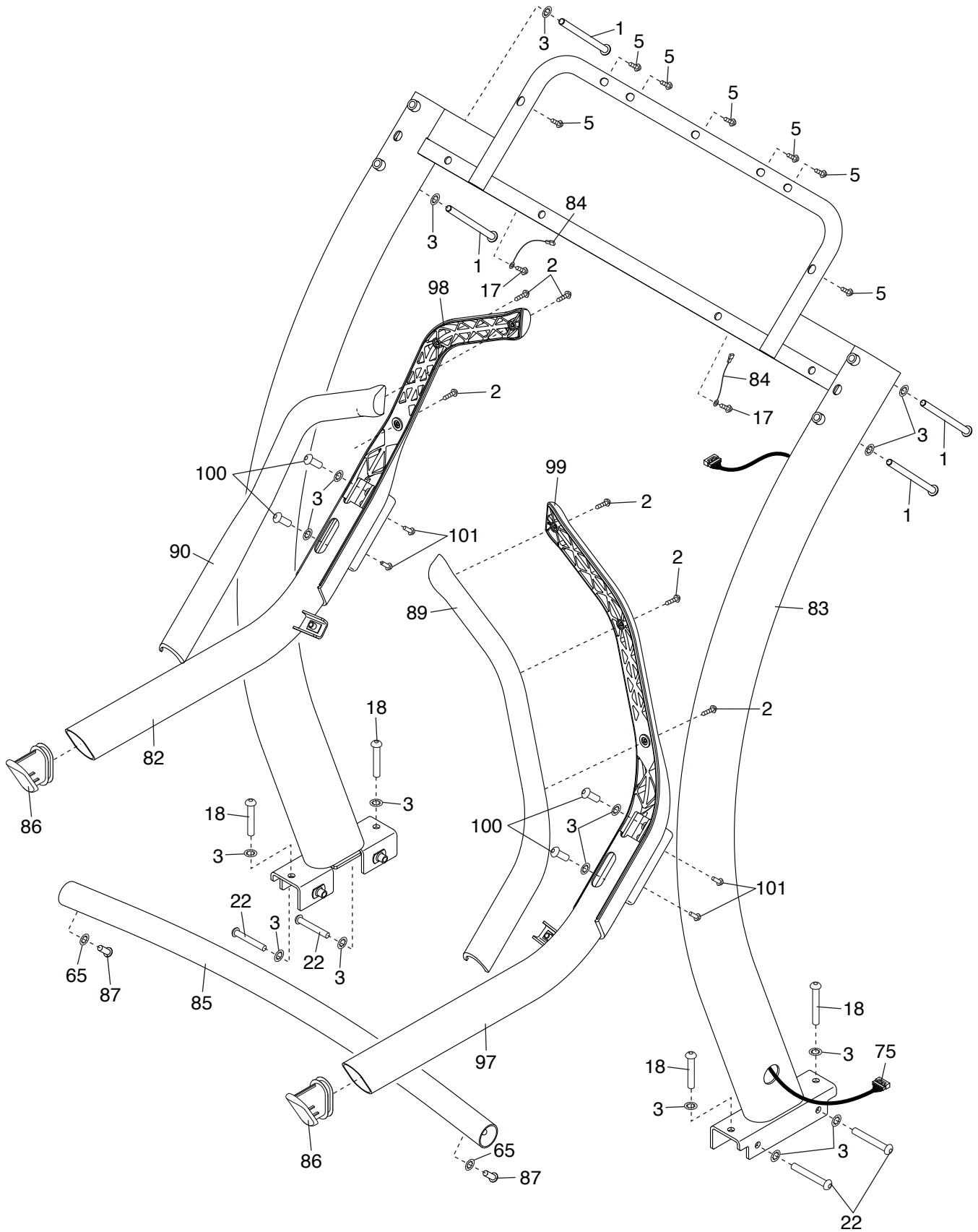

EXPLODED DRAWING E

Model No. NTL22019.0 R1218A

