

EXPLODED DRAWING A

Model No. NTL24012.0 R1012A

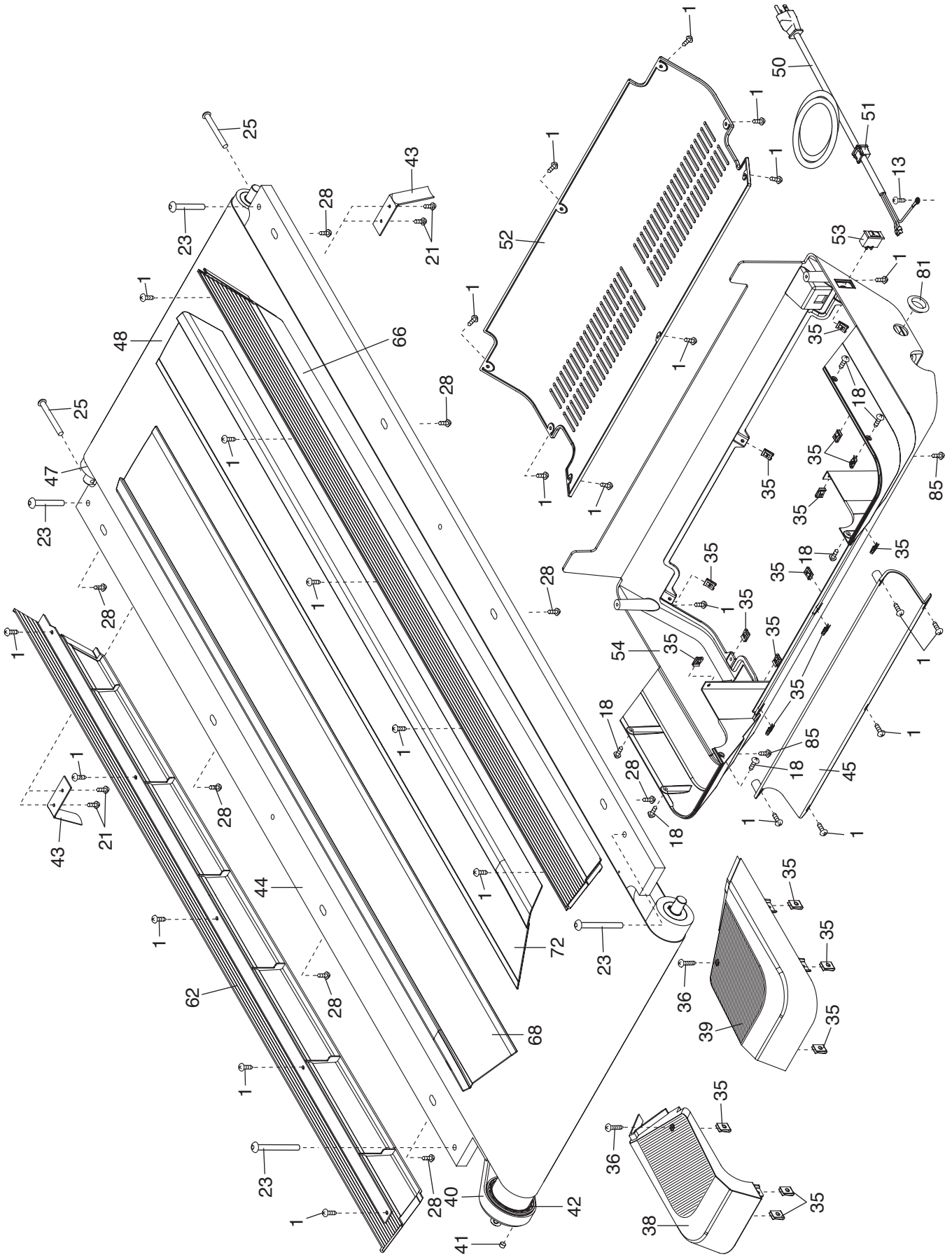

EXPLODED DRAWING B

Model No. NTL24012.0 R1012A

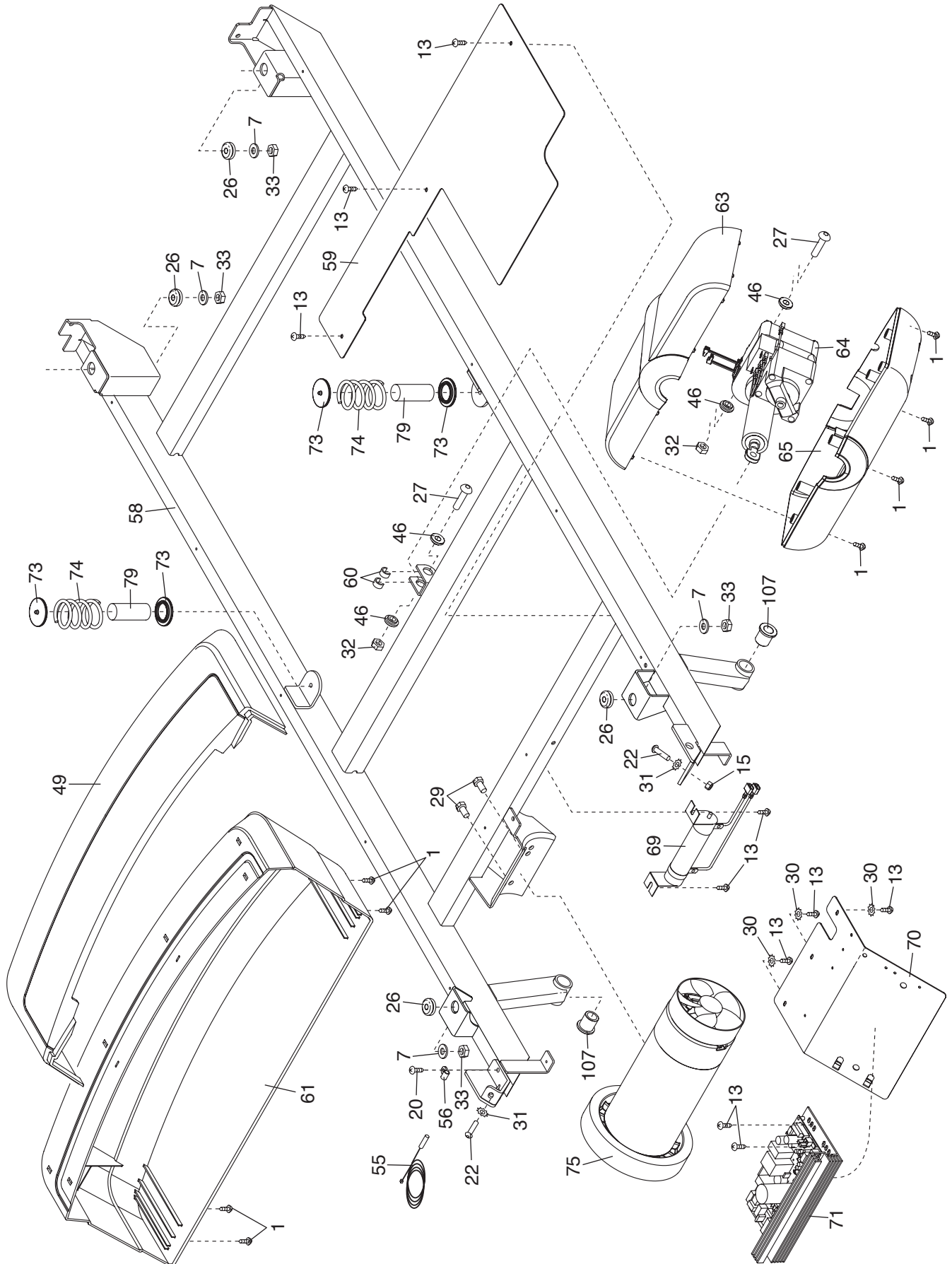

EXPLODED DRAWING D

Model No. NTL24012.0 R1012A

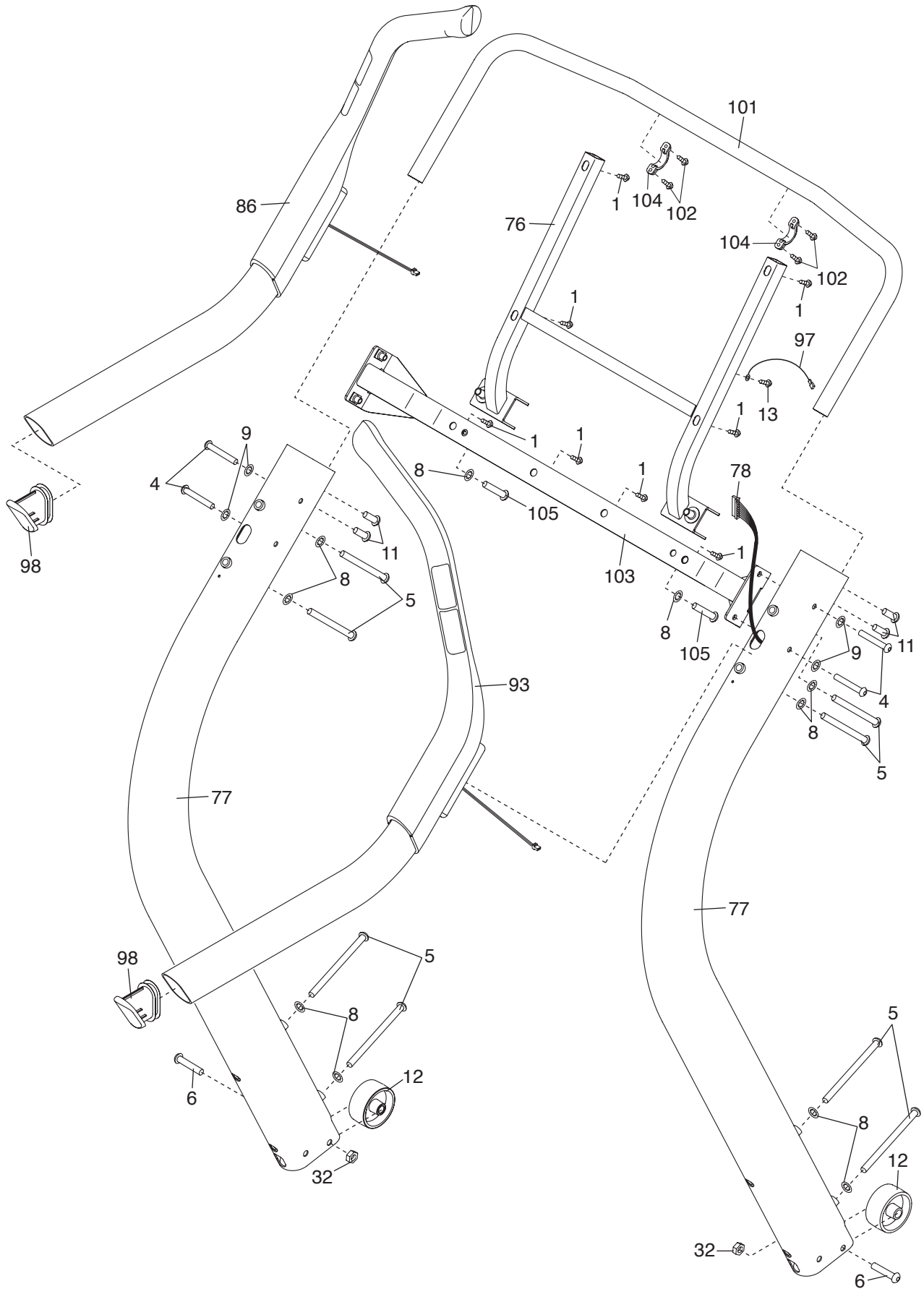

EXPLODED DRAWING E

Model No. NTL24012.0 R1012A

