

# EXPLODED DRAWING A

Model No. NTL24016.4 R0918A

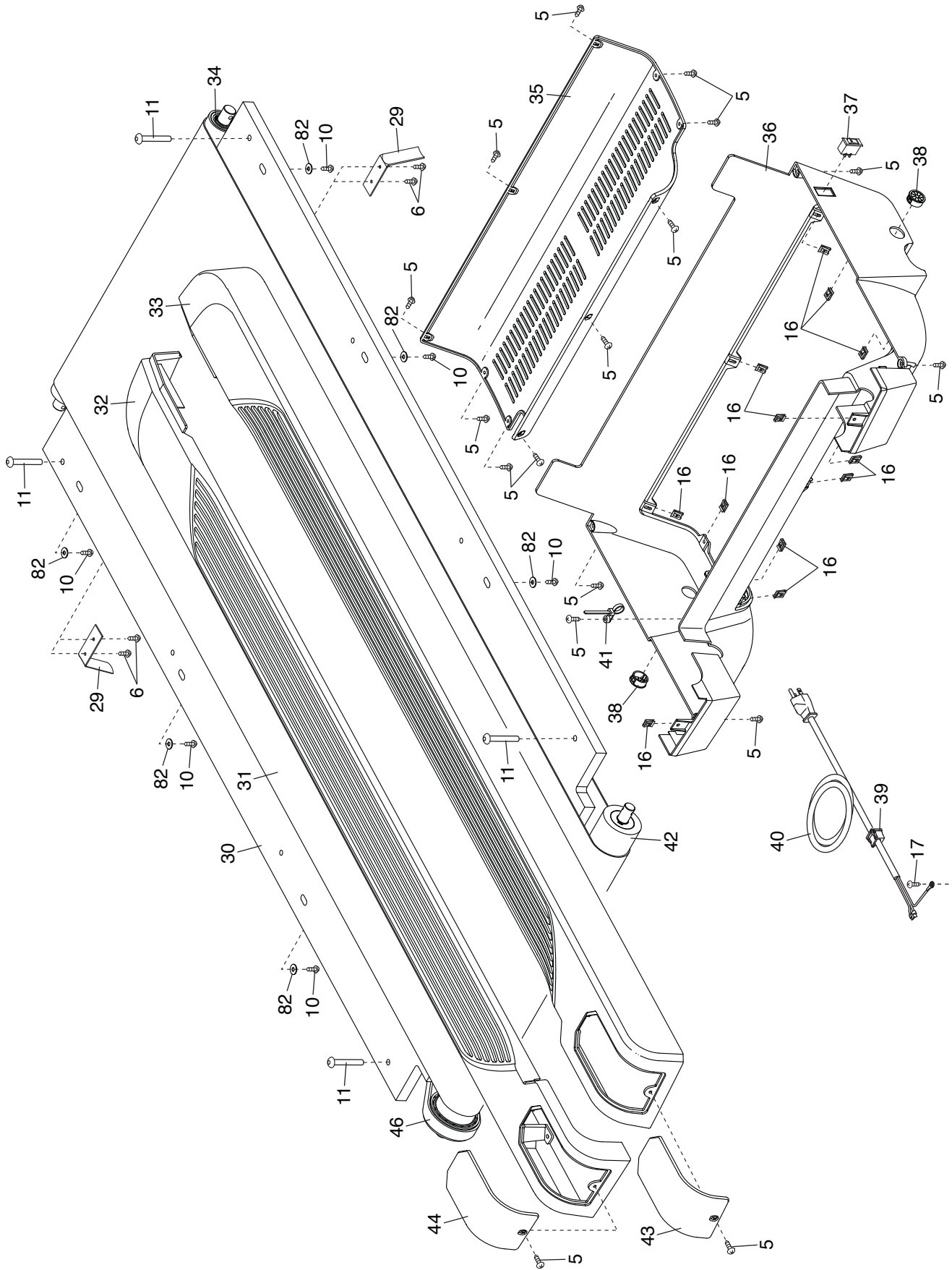

# EXPLODED DRAWING B

Model No. NTL24016.4 R0918A

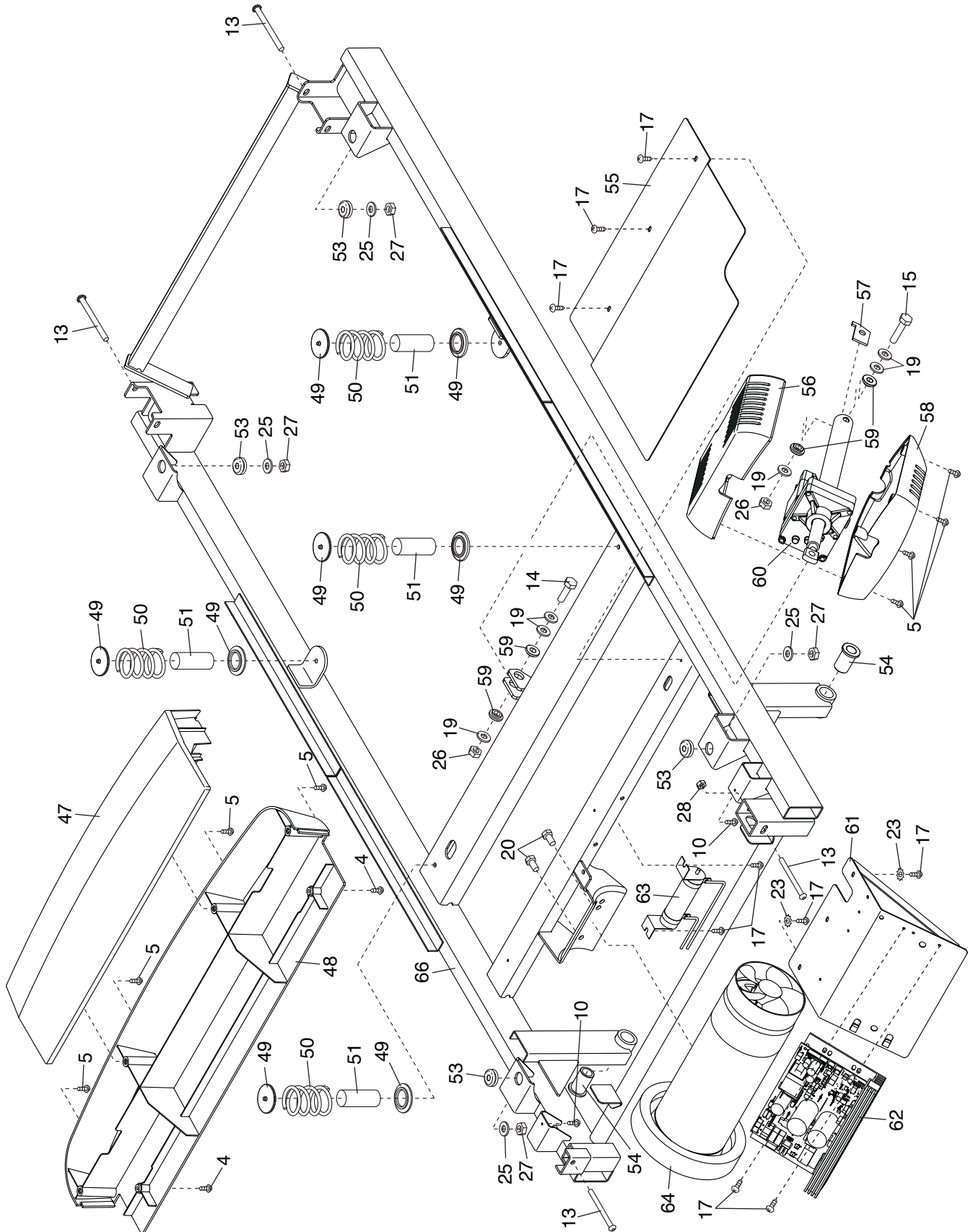

# EXPLODED DRAWING C

Model No. NTL24016.4 R0918A

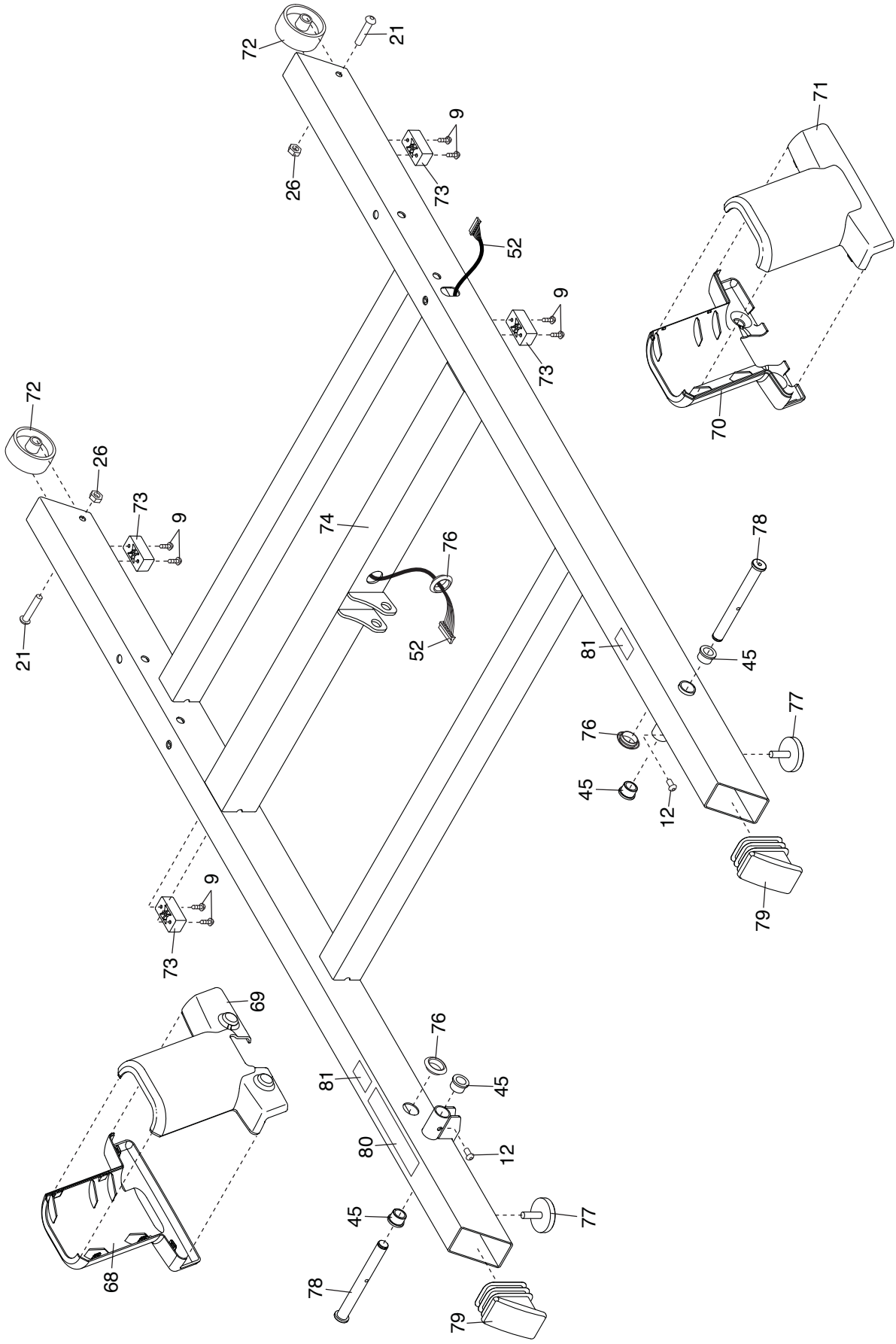

# EXPLODED DRAWING D

Model No. NTL24016.4 R0918A

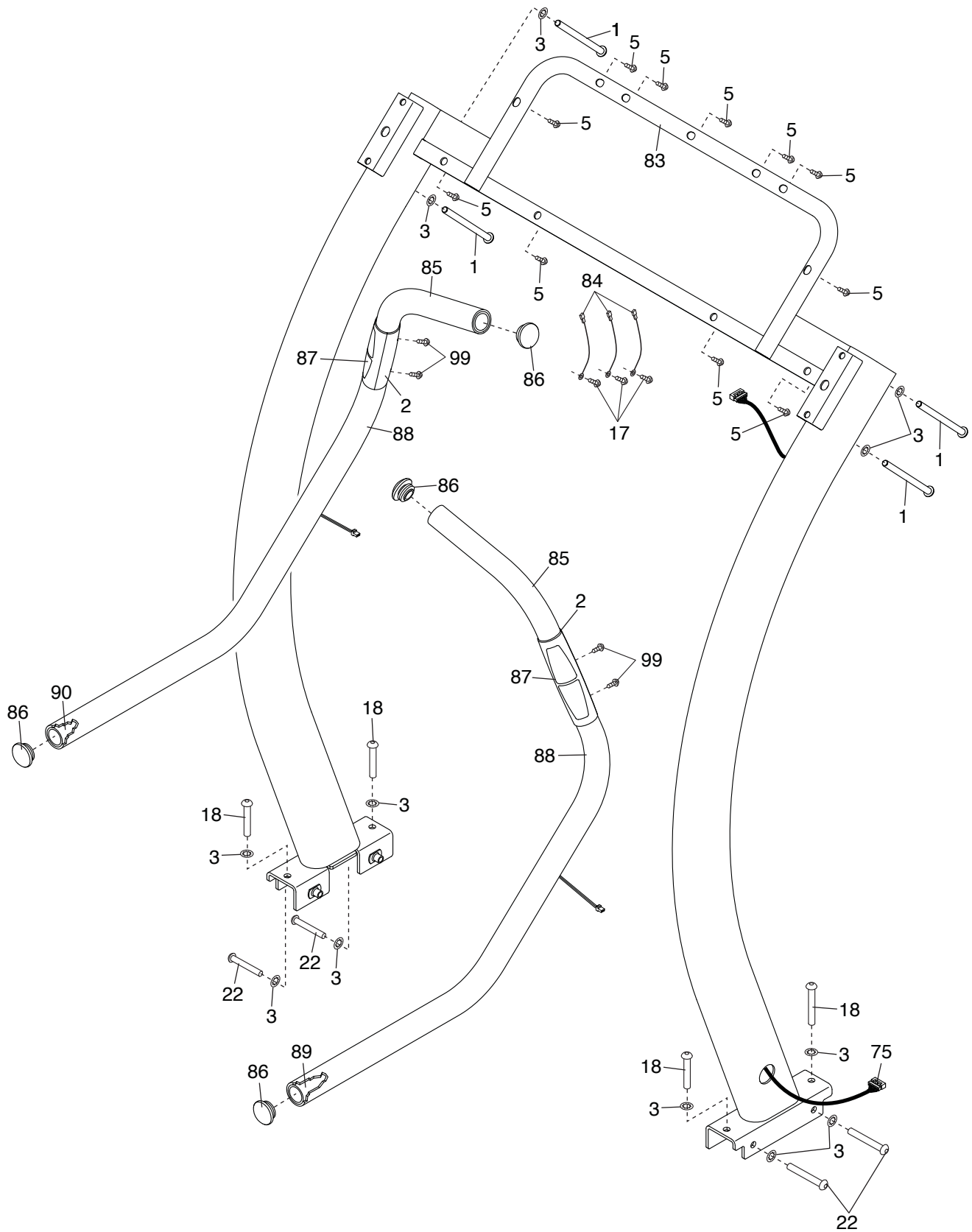

# EXPLODED DRAWING E

Model No. NTL24016.4 R0918A

