

# EXPLODED DRAWING A

Model No. NTL24016.6 R1018A

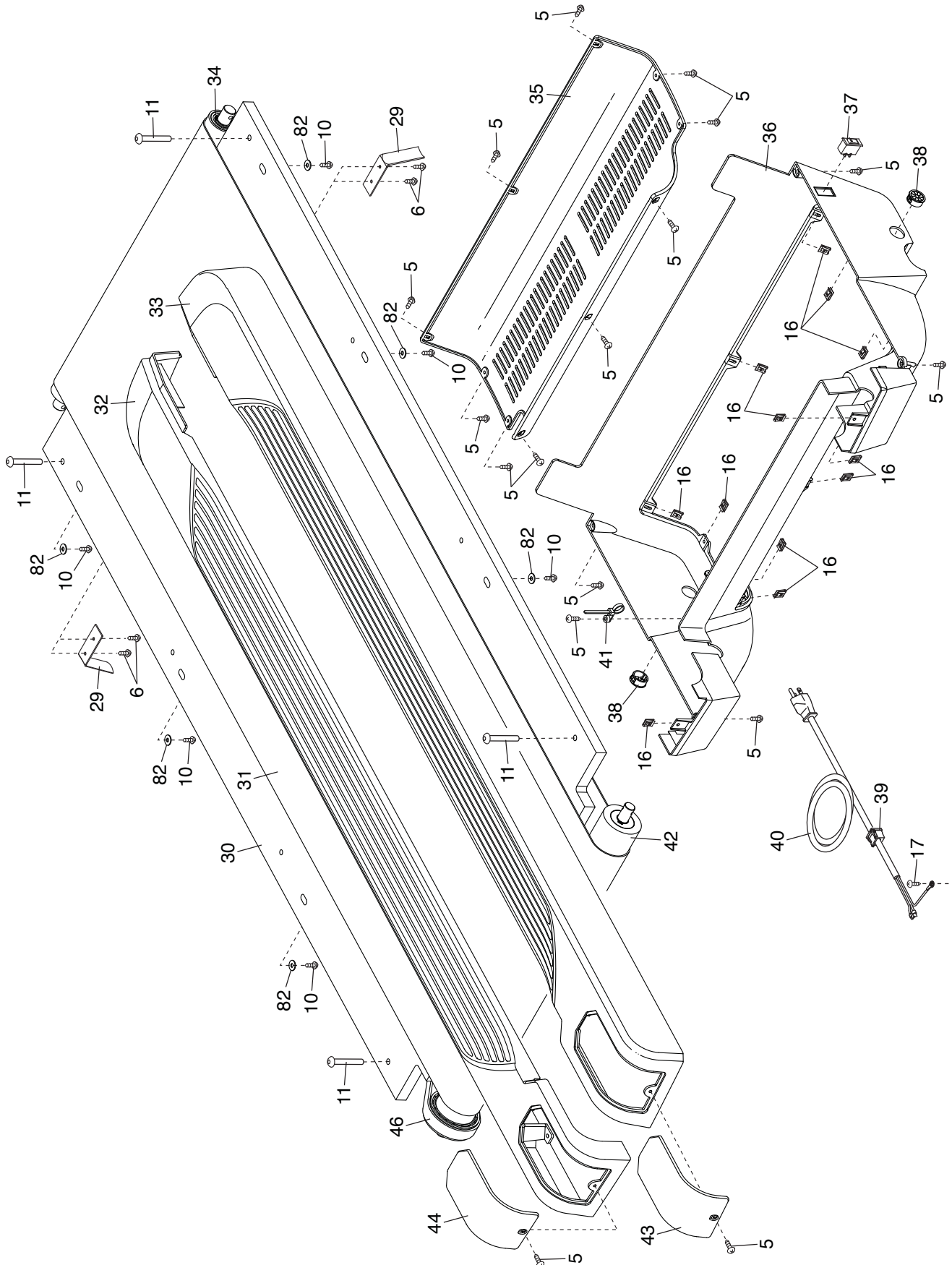

# EXPLODED DRAWING B

Model No. NTL24016.6 R1018A

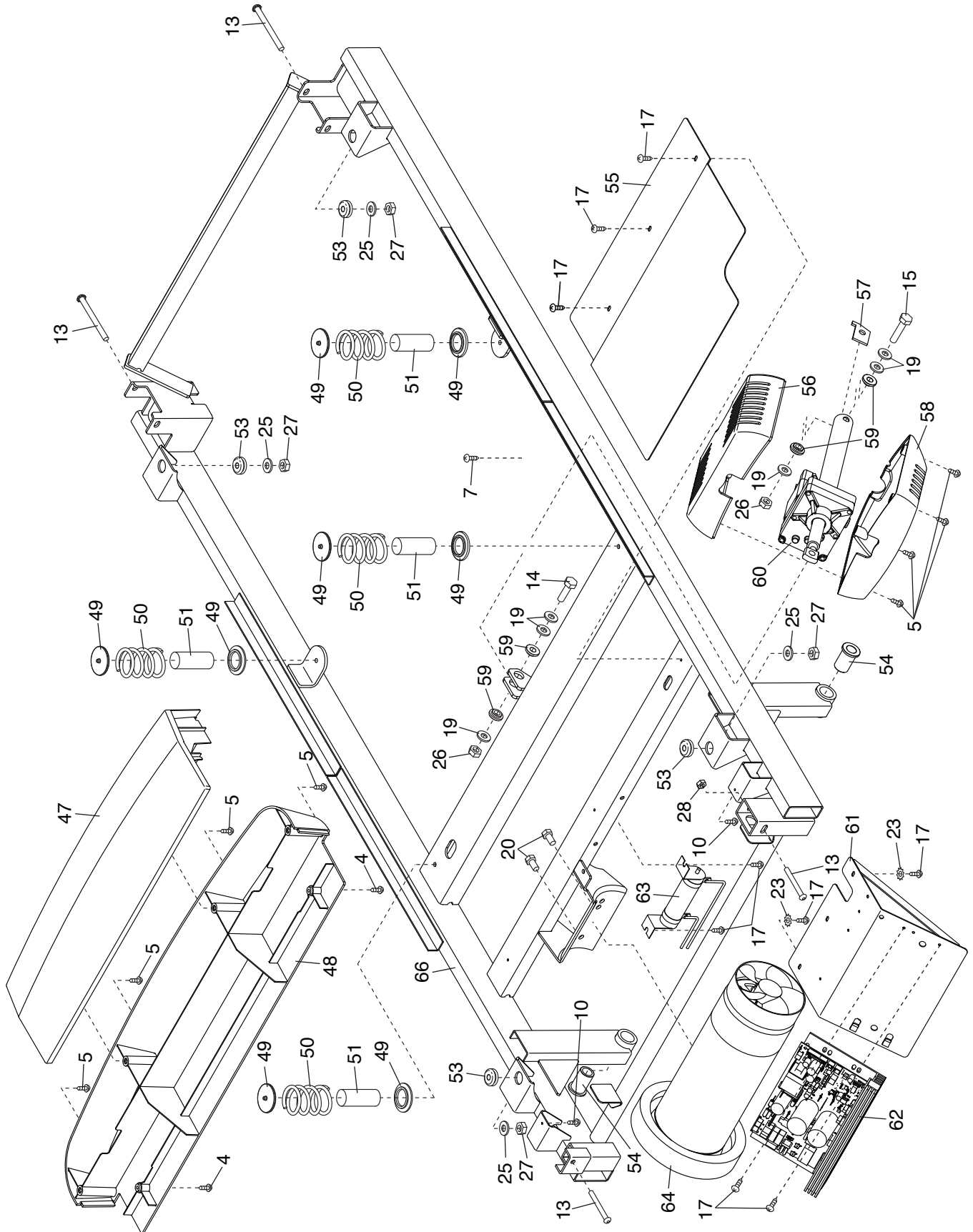

# EXPLODED DRAWING C

Model No. NTL24016.6 R1018A

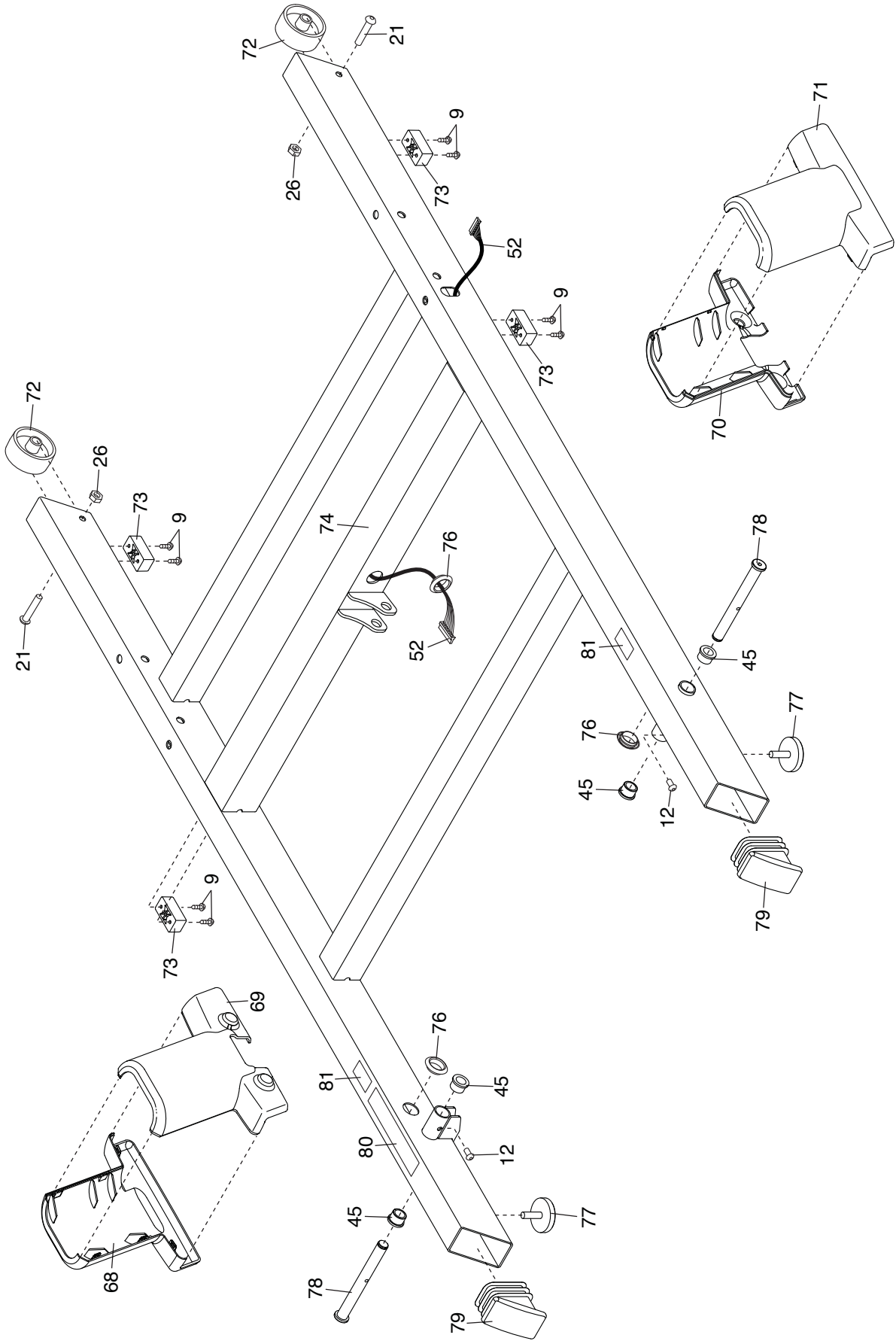

# EXPLODED DRAWING D

Model No. NTL24016.6 R1018A

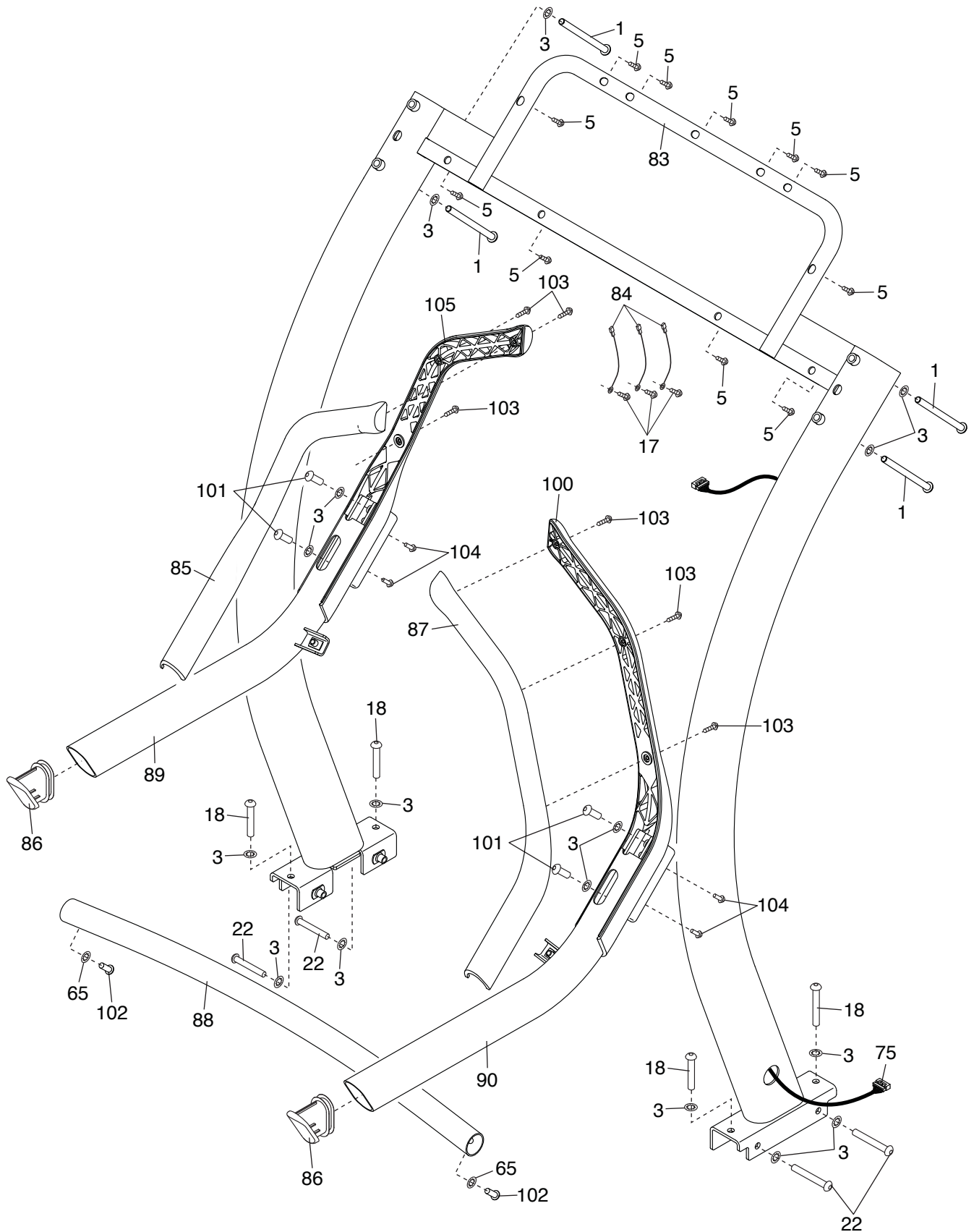

# EXPLODED DRAWING E

Model No. NTL24016.6 R1018A

