

EXPLODED DRAWING A

Model No. NTL24019.0 R1218B

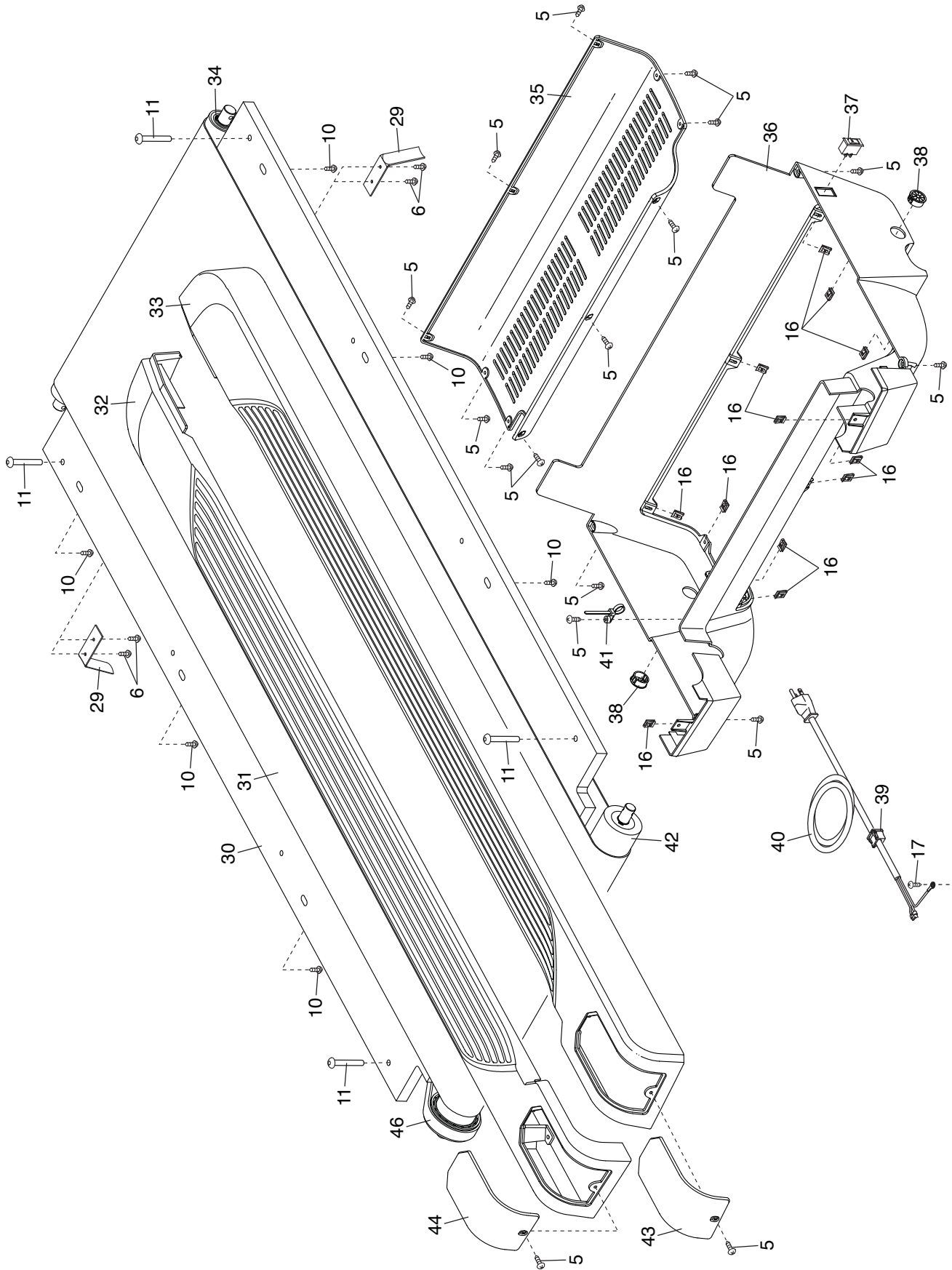

EXPLODED DRAWING B

Model No. NTL24019.0 R1218B

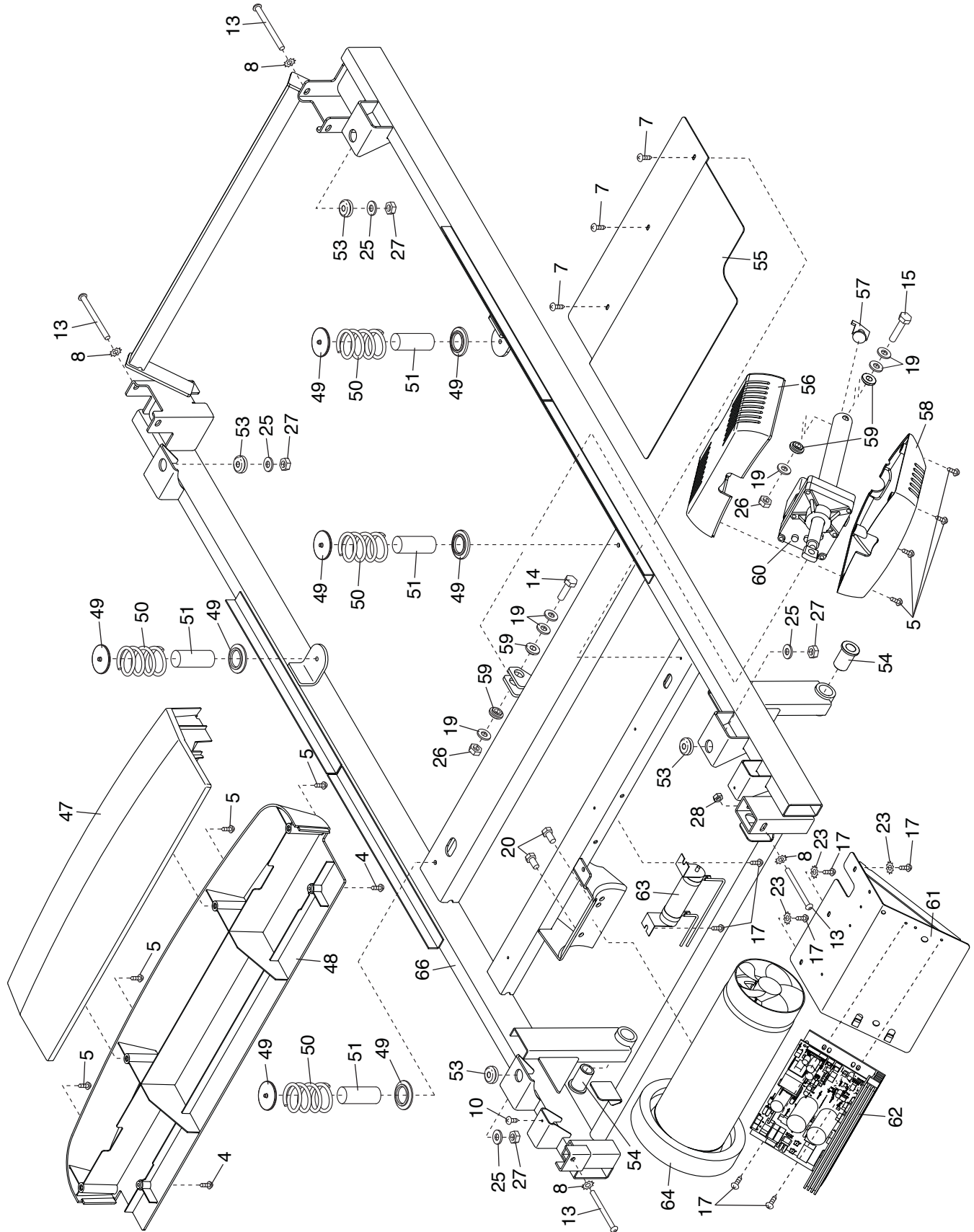

EXPLODED DRAWING C

Model No. NTL24019.0 R1218B

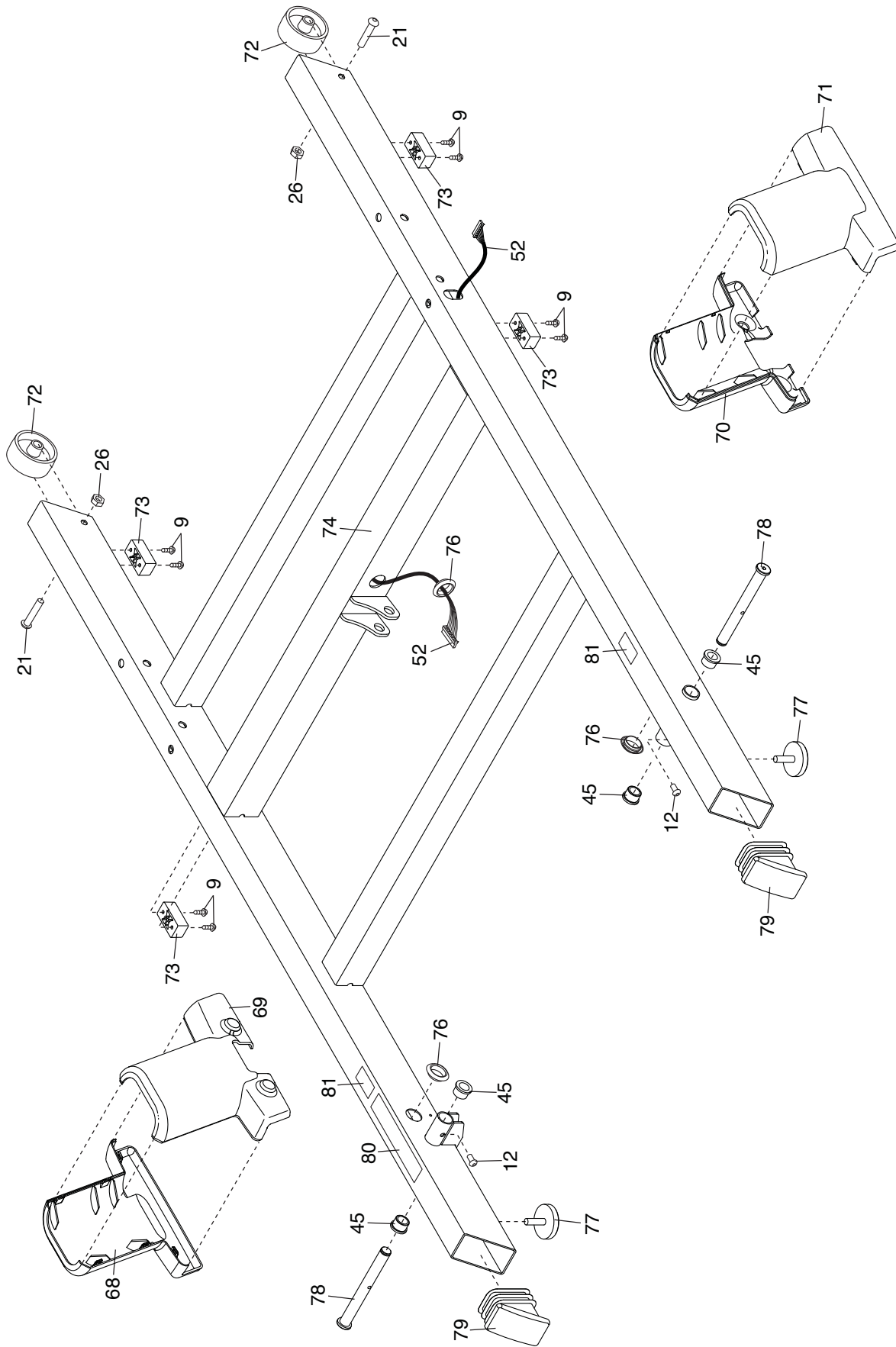

EXPLODED DRAWING D

Model No. NTL24019.0 R1218B

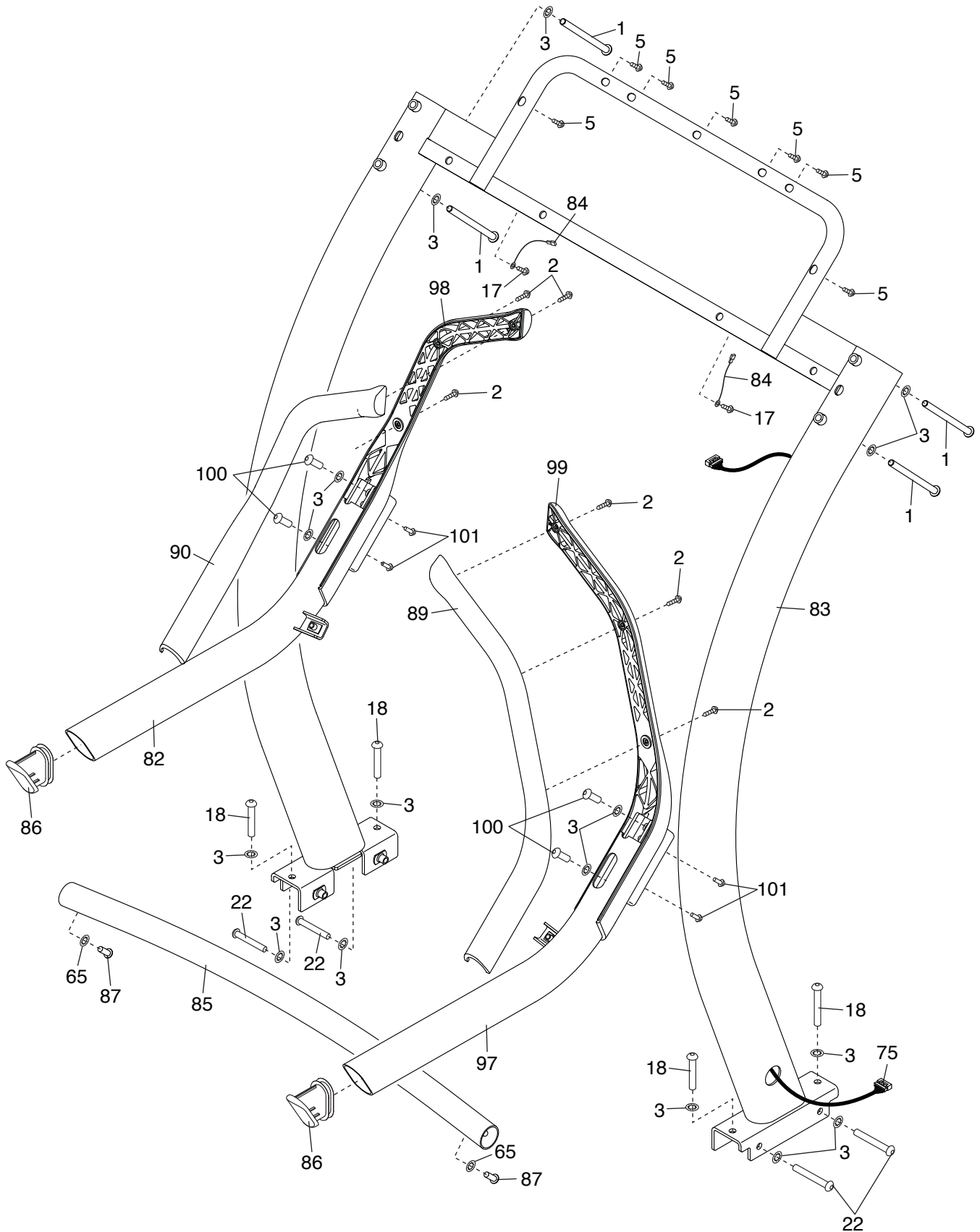

EXPLODED DRAWING E

Model No. NTL24019.0 R1218B

