

EXPLODED DRAWING A

Model No. NTL29019.0 R0119A

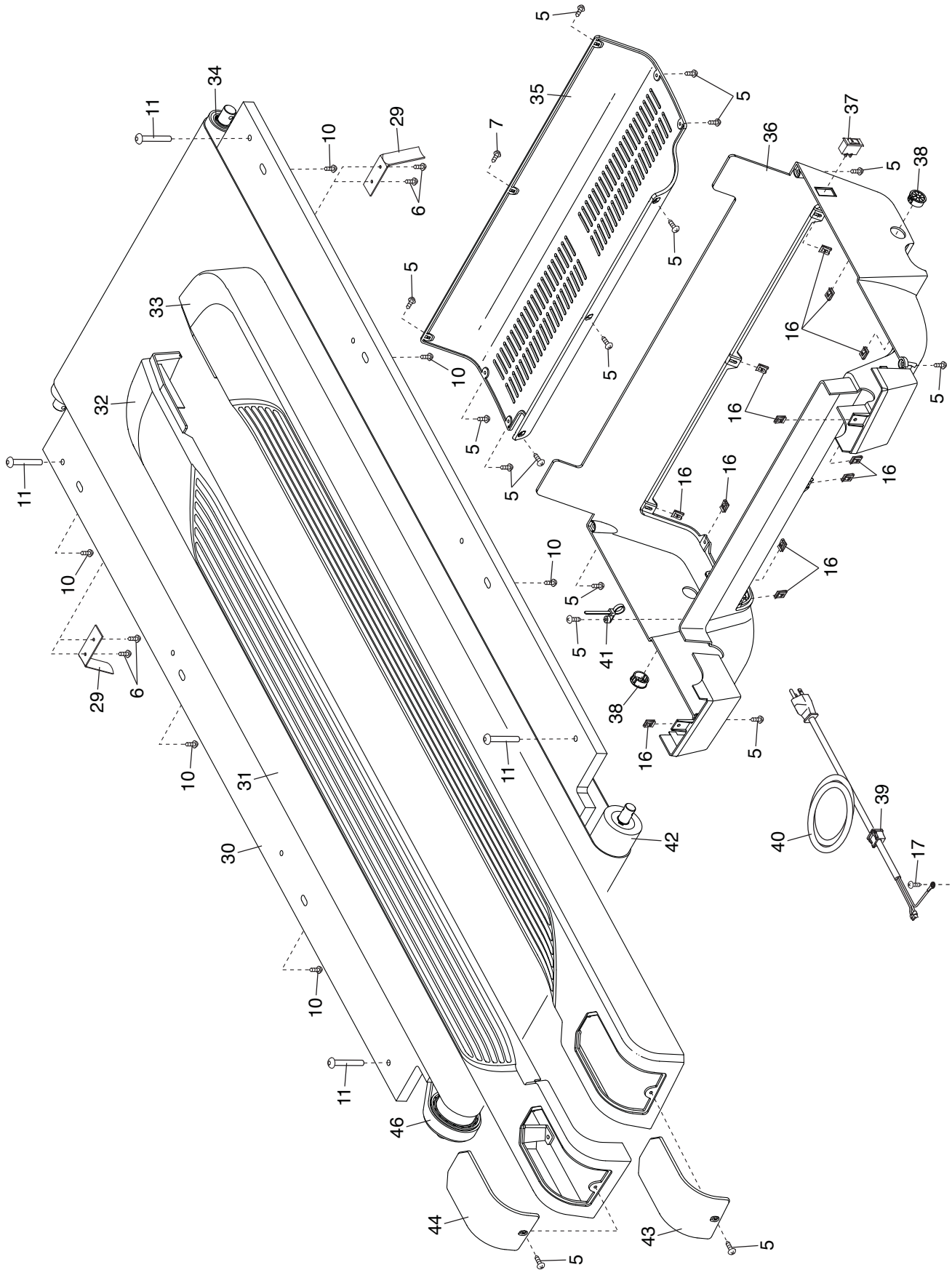

EXPLODED DRAWING B

Model No. NTL29019.0 R0119A

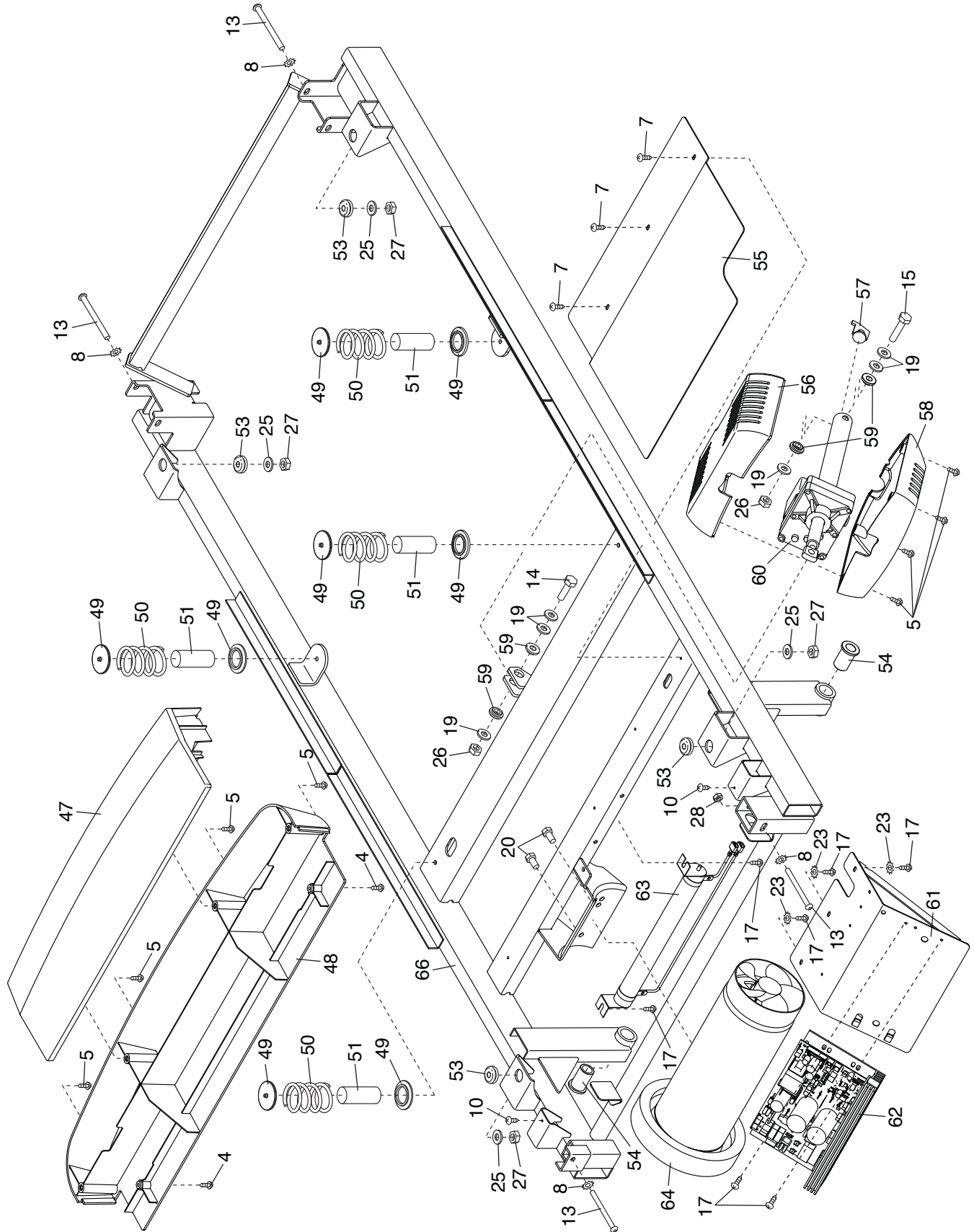

EXPLODED DRAWING C

Model No. NTL29019.0 R0119A

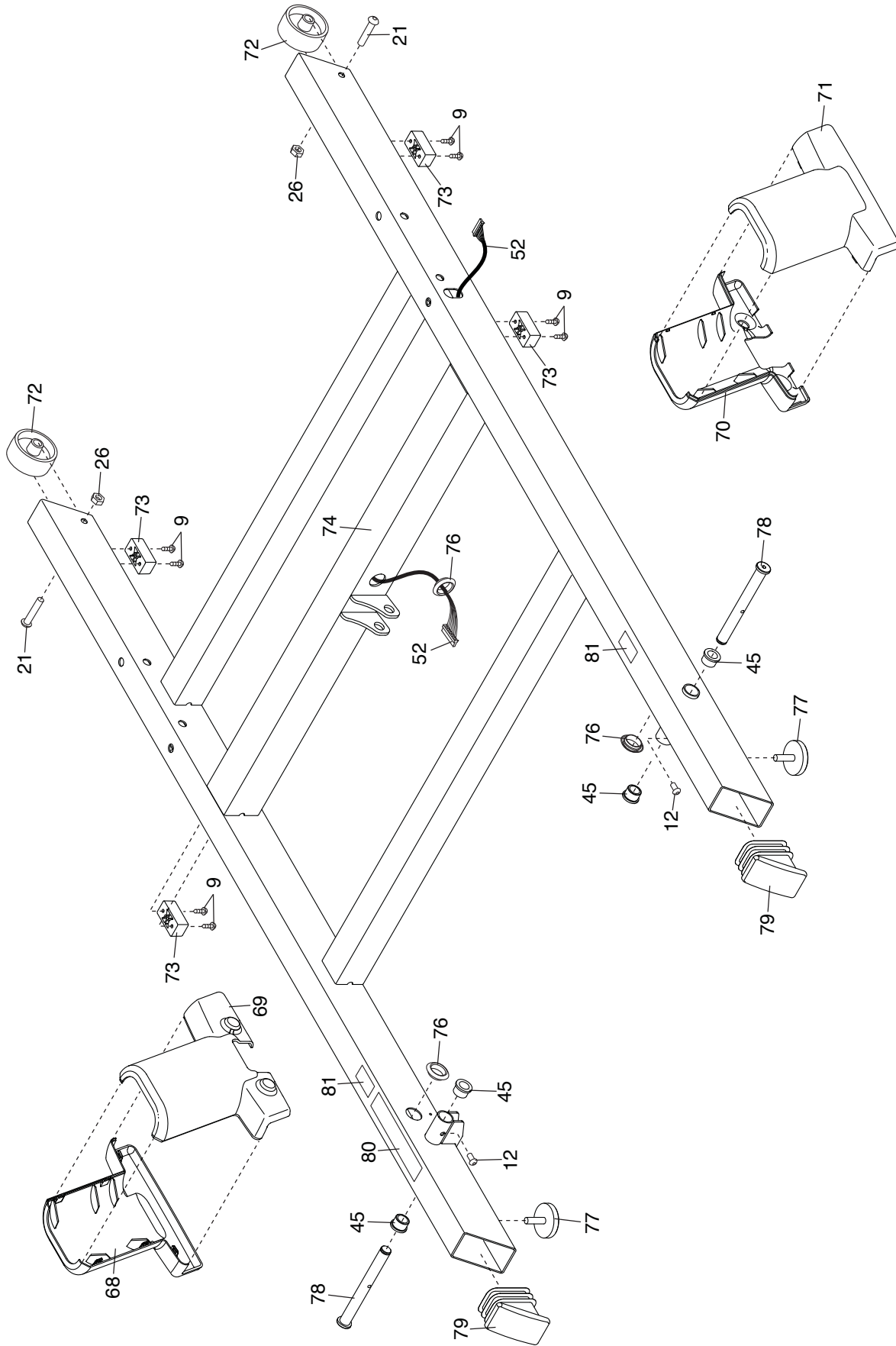

EXPLODED DRAWING D

Model No. NTL29019.0 R0119A

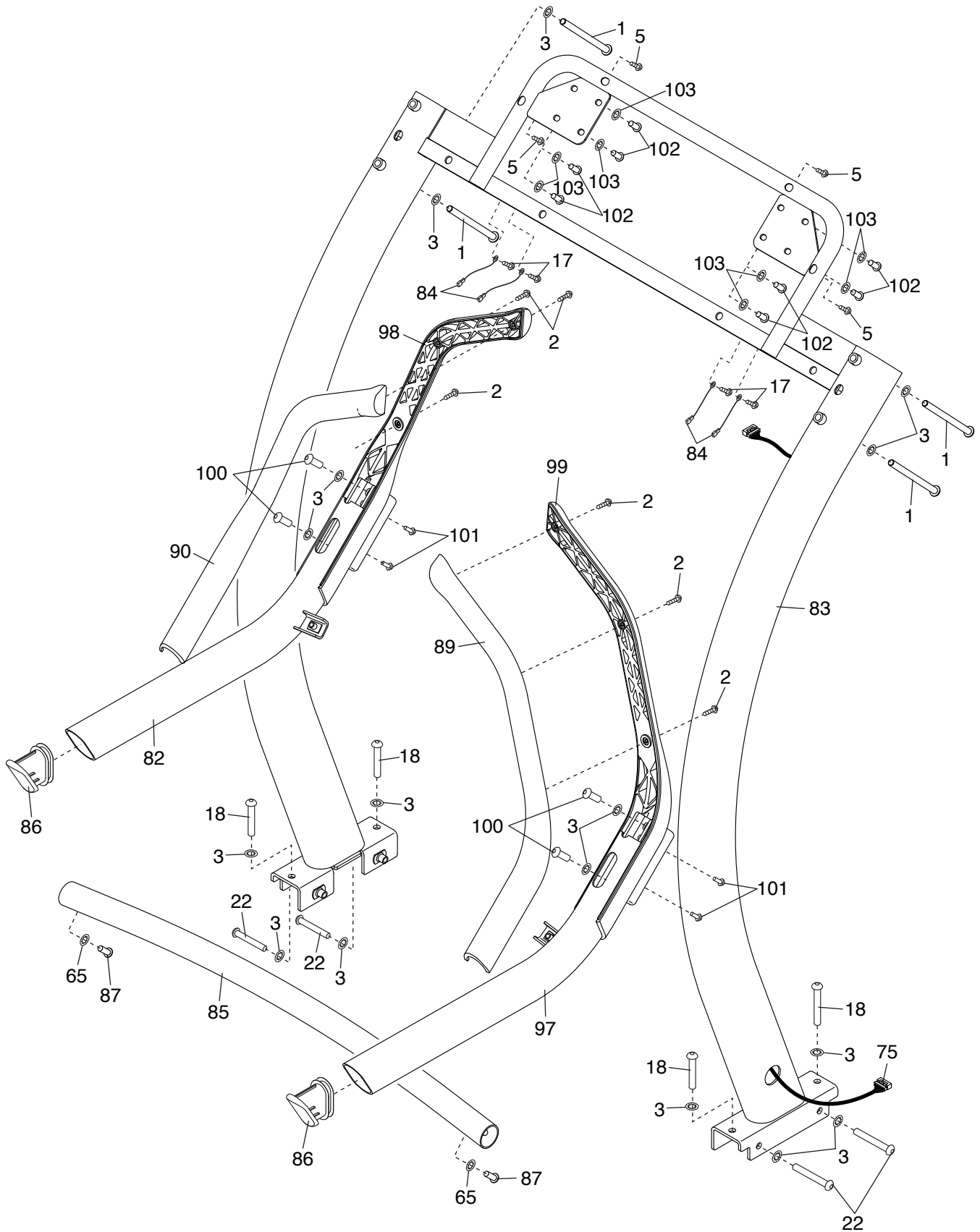

EXPLODED DRAWING E

Model No. NTL29019.0 R0119A

