

# EXPLODED DRAWING A

Model No. NTL29221.2 R1120A

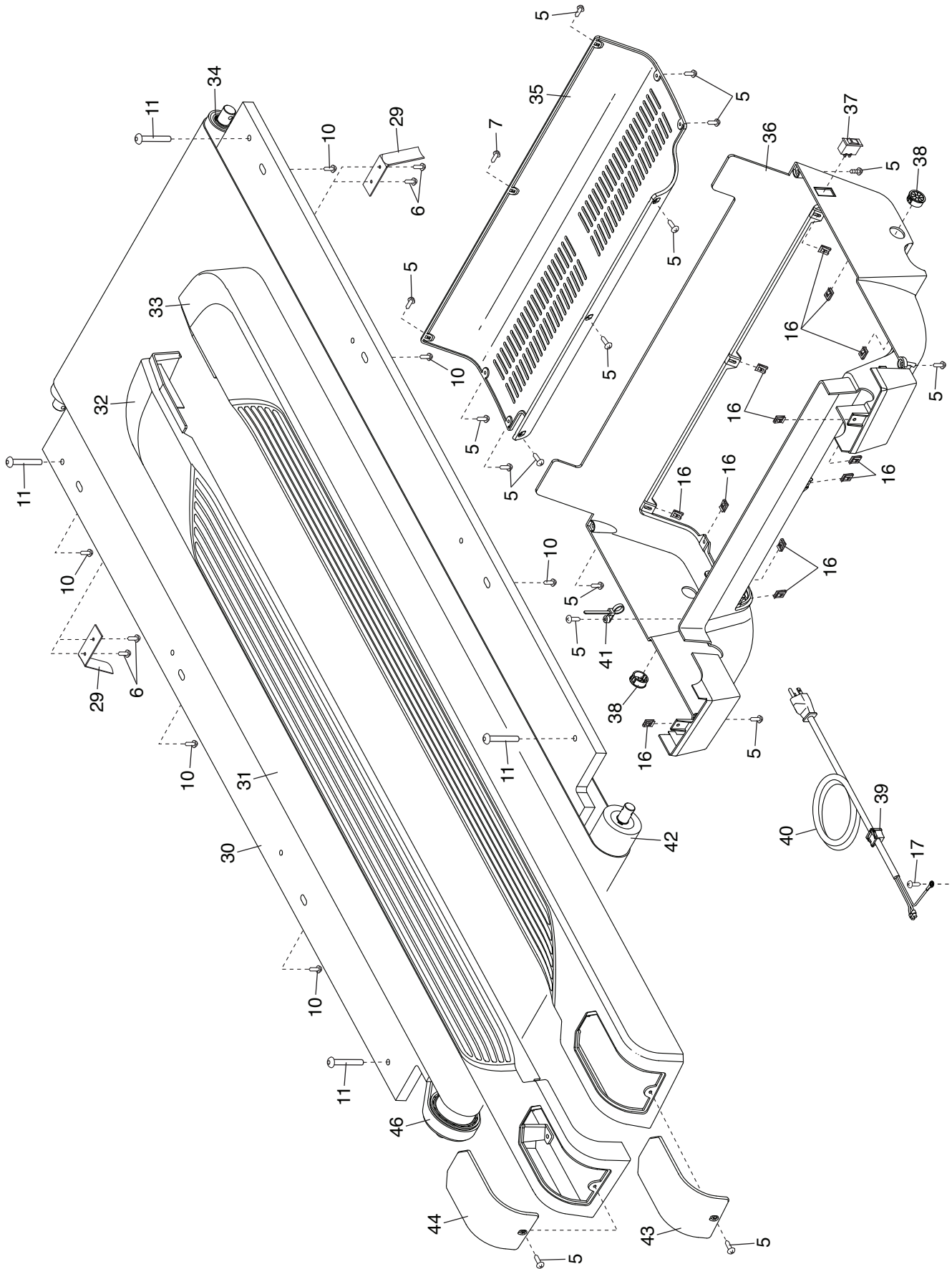

# EXPLODED DRAWING B

Model No. NTL29221.2 R1120A

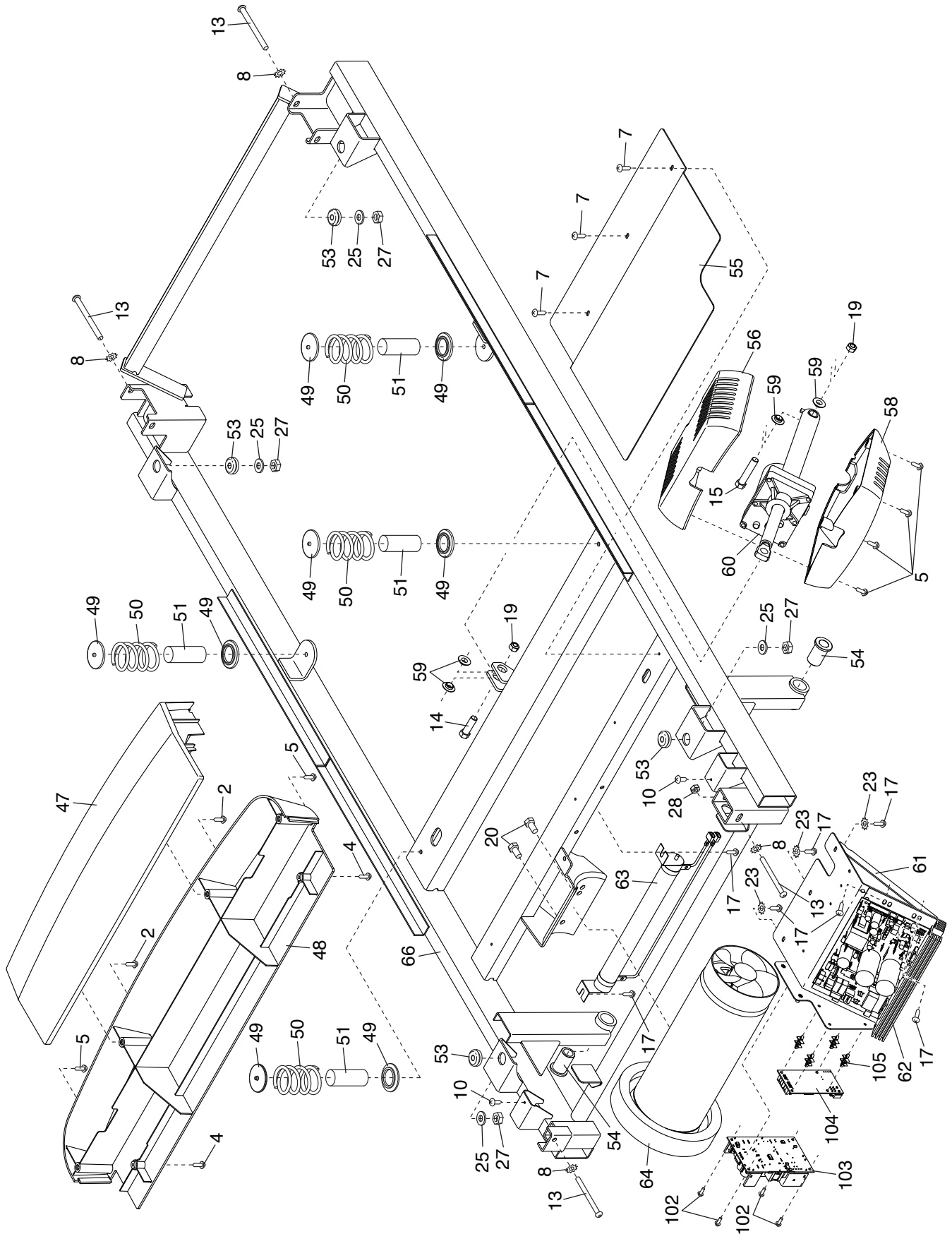



# EXPLODED DRAWING D

Model No. NTL29221.2 R1120A

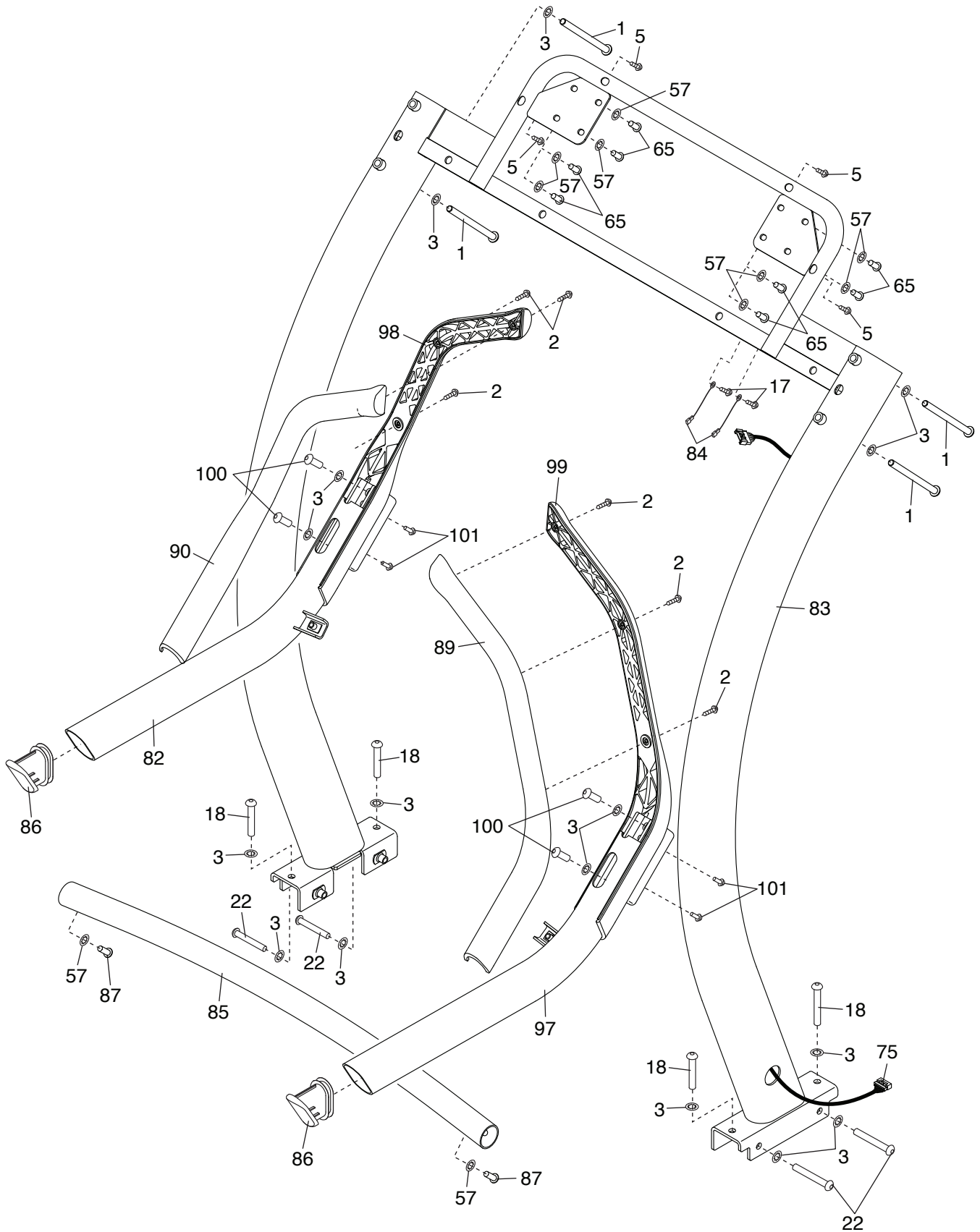

# EXPLODED DRAWING E

Model No. NTL29221.2 R1120A

