

EXPLODED DRAWING A

Model No. NTL39221.1 R1022A

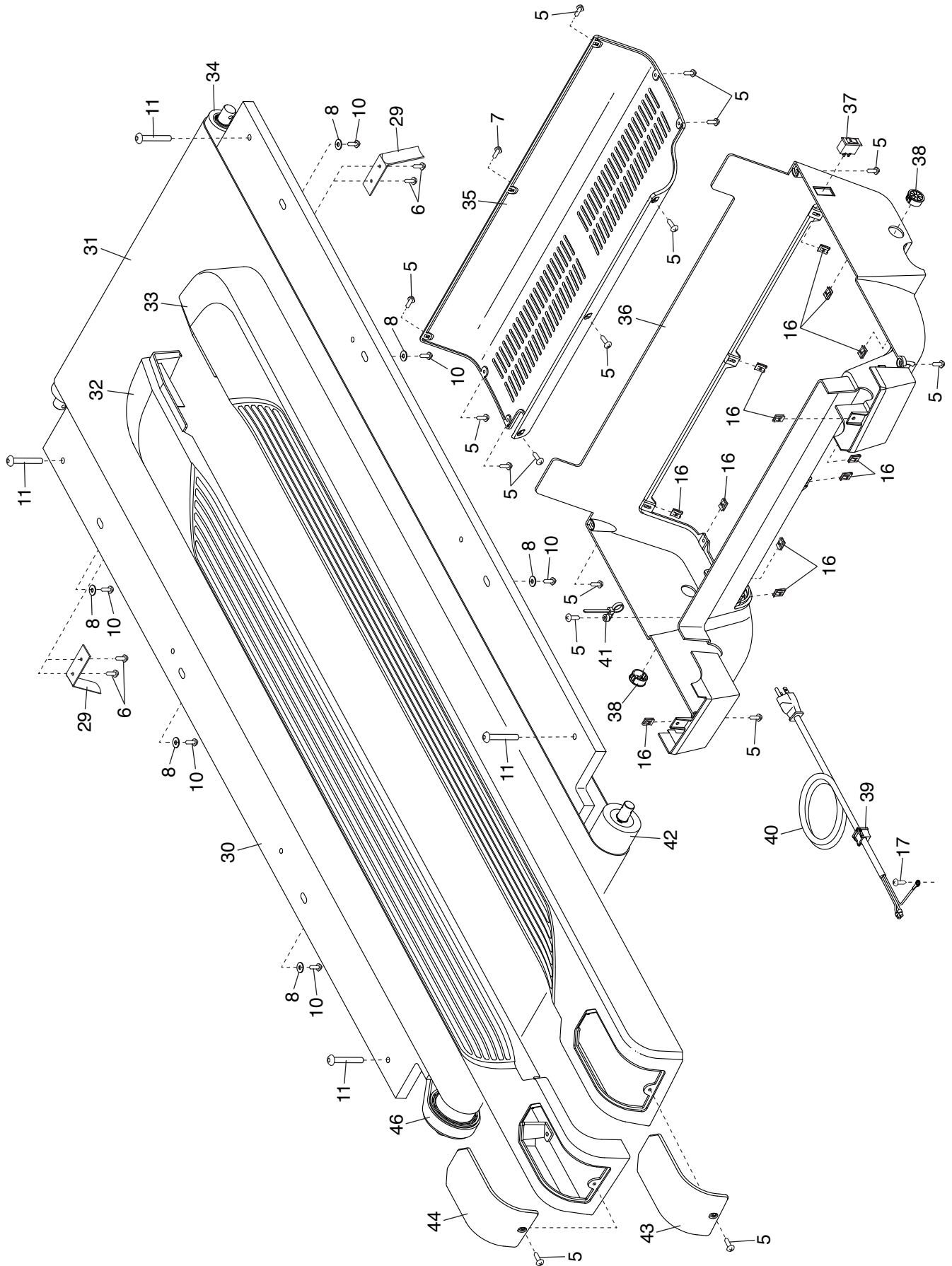

EXPLODED DRAWING B

Model No. NTL39221.1 R1022A

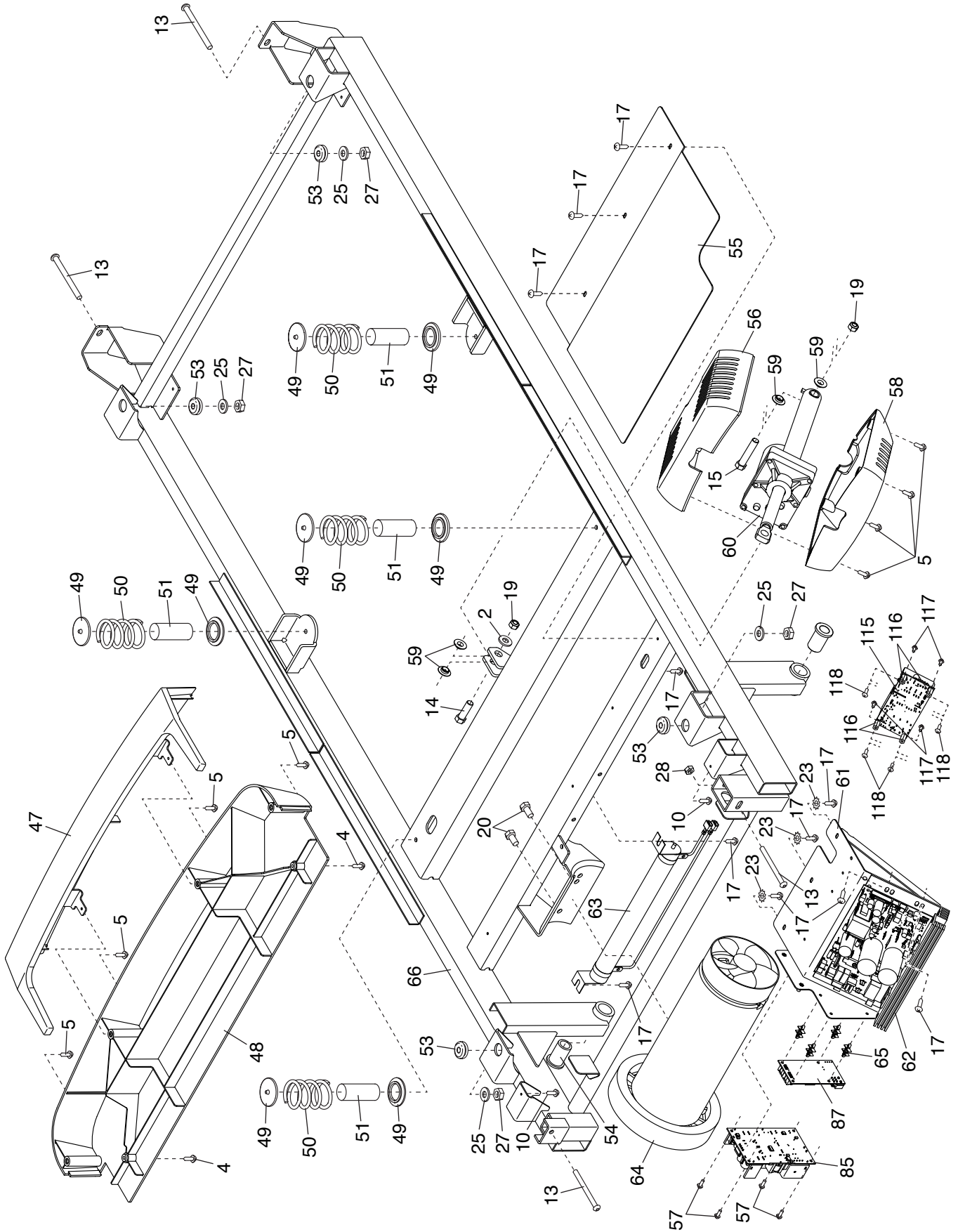

EXPLODED DRAWING C

Model No. NTL39221.1 R1022A

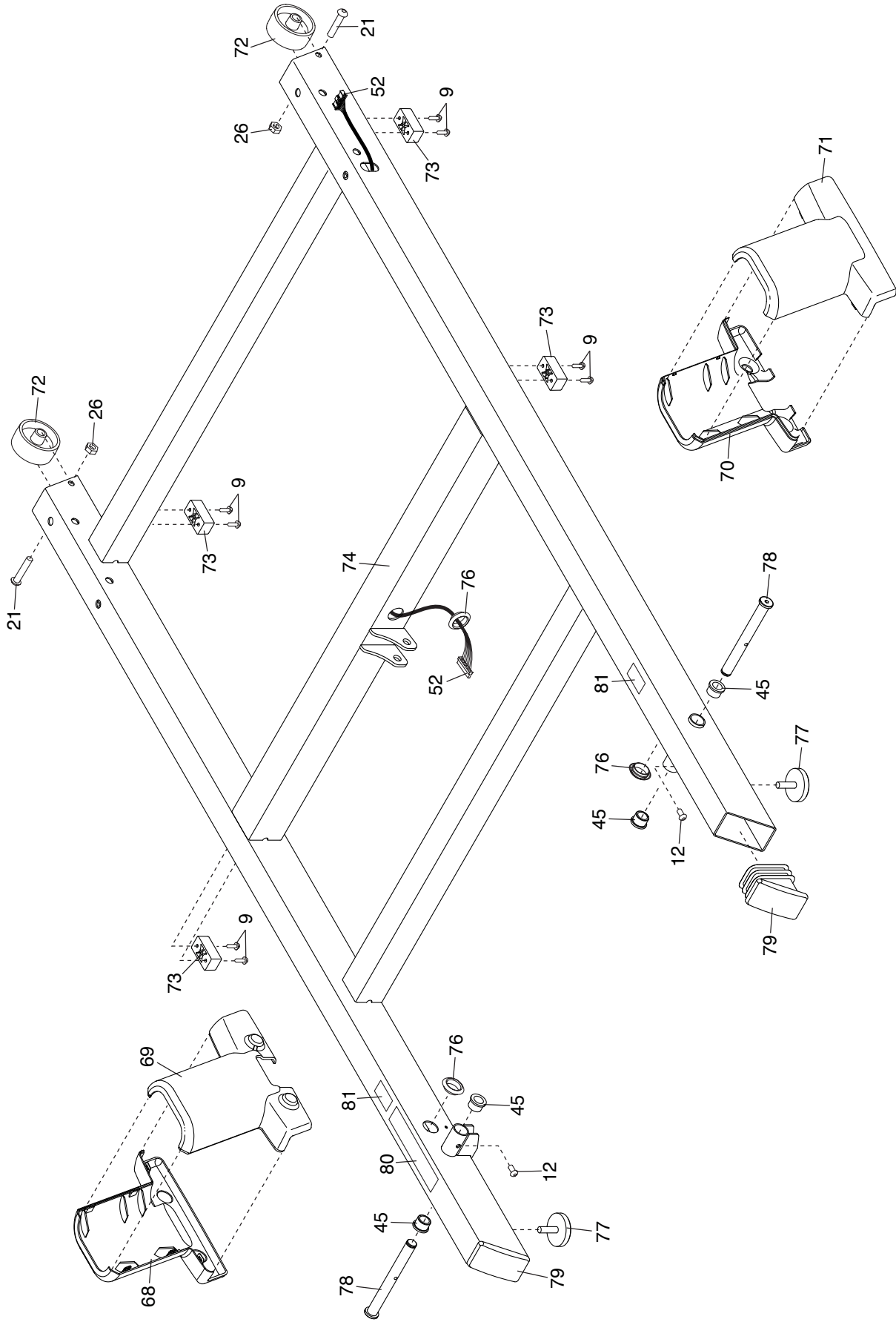

EXPLODED DRAWING D

Model No. NTL39221.1 R1022A

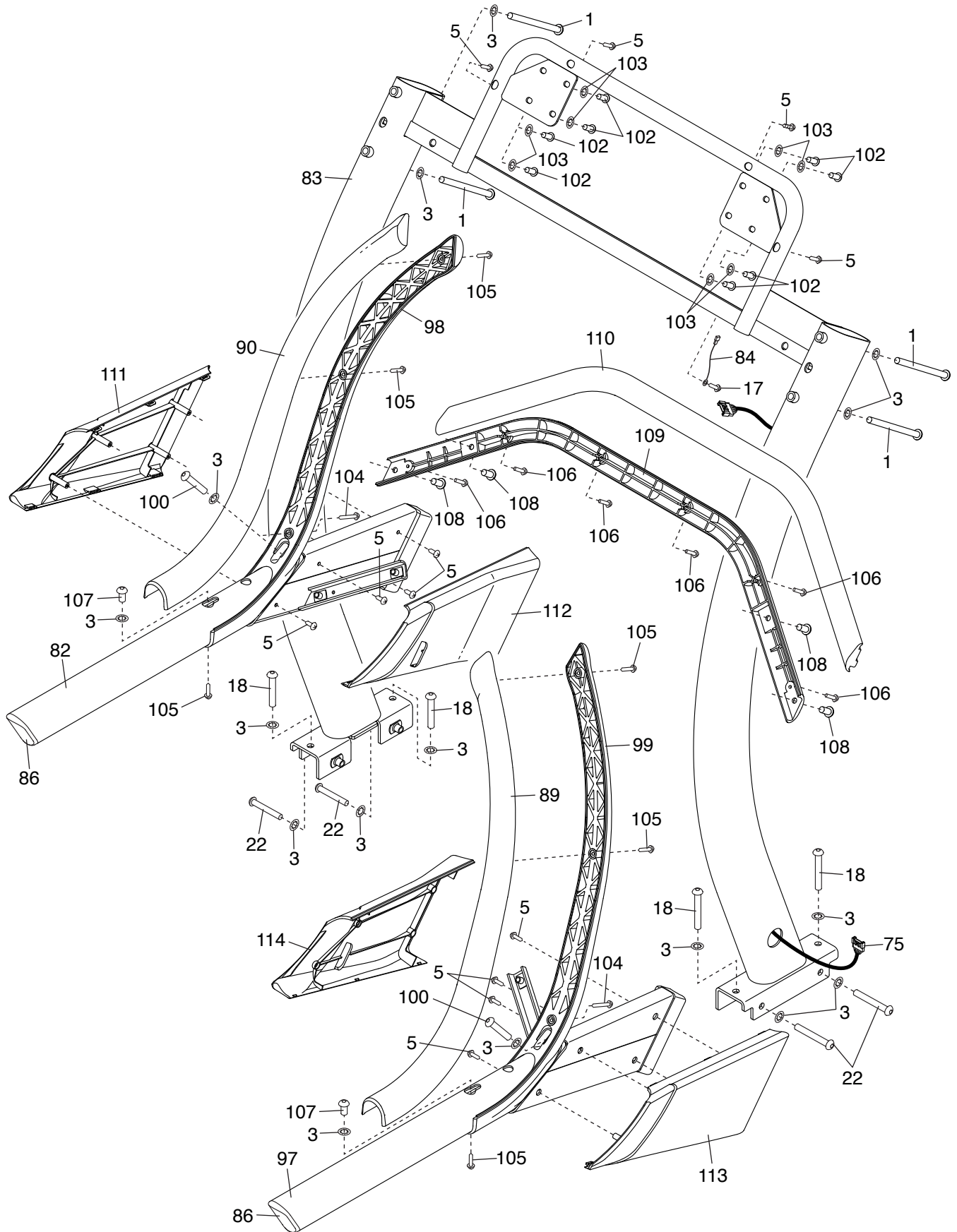

EXPLODED DRAWING E

Model No. NTL39221.1 R1022A

