

EXPLODED DRAWING A

Model No. NTL39222.2 R0922A

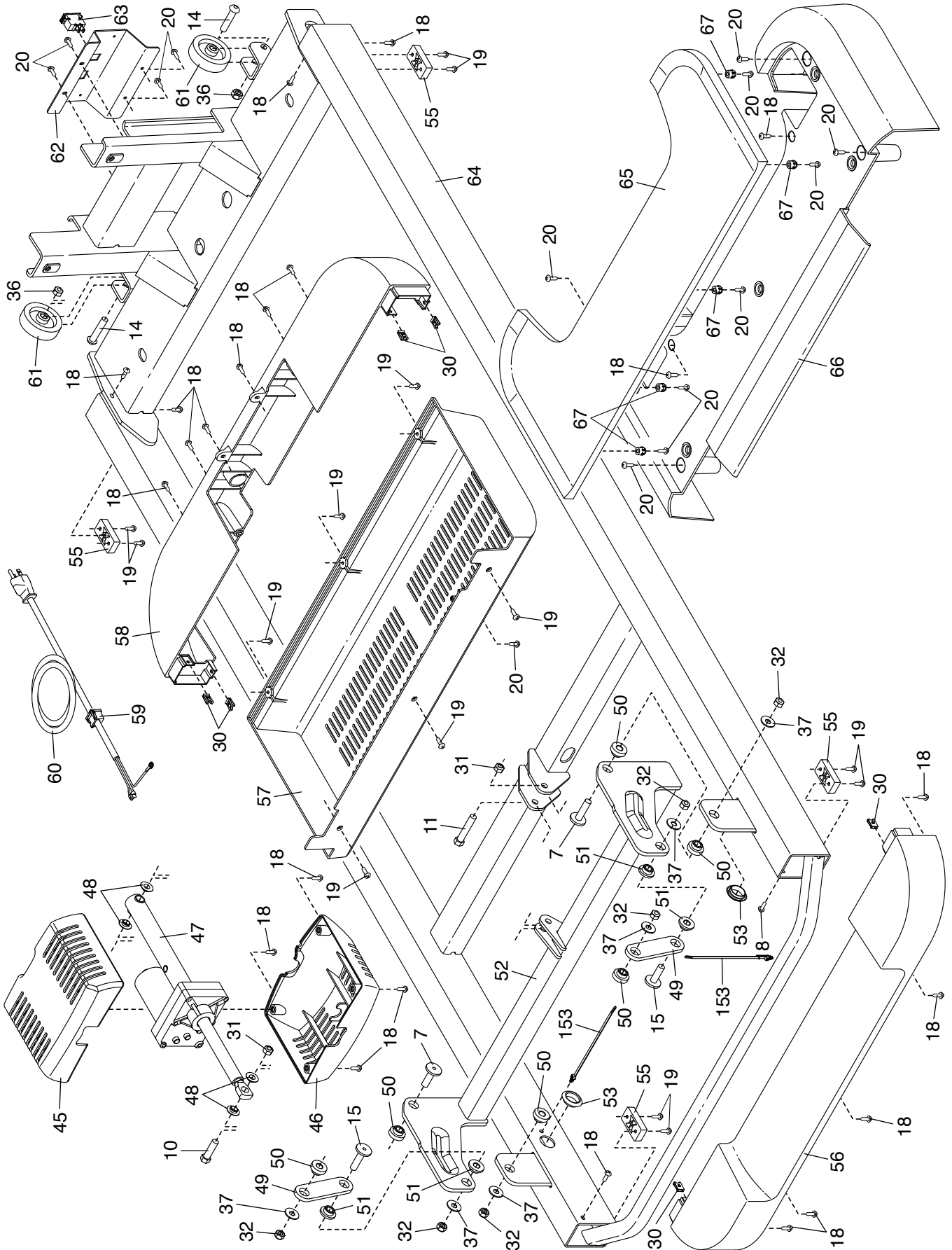

EXPLODED DRAWING B

Model No. NTL39222.2 R0922A

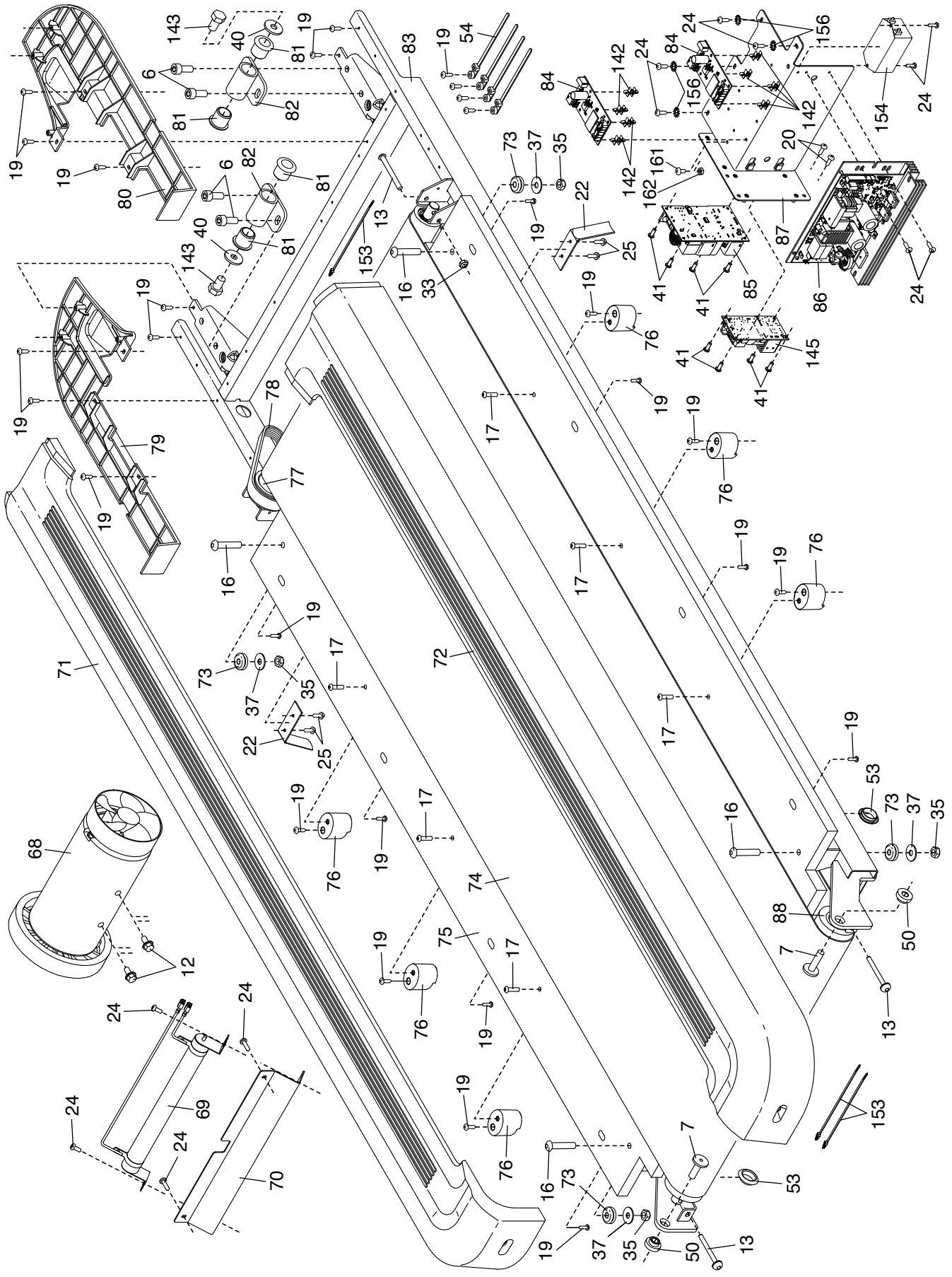

EXPLODED DRAWING C

Model No. NTL39222.2 R0922A

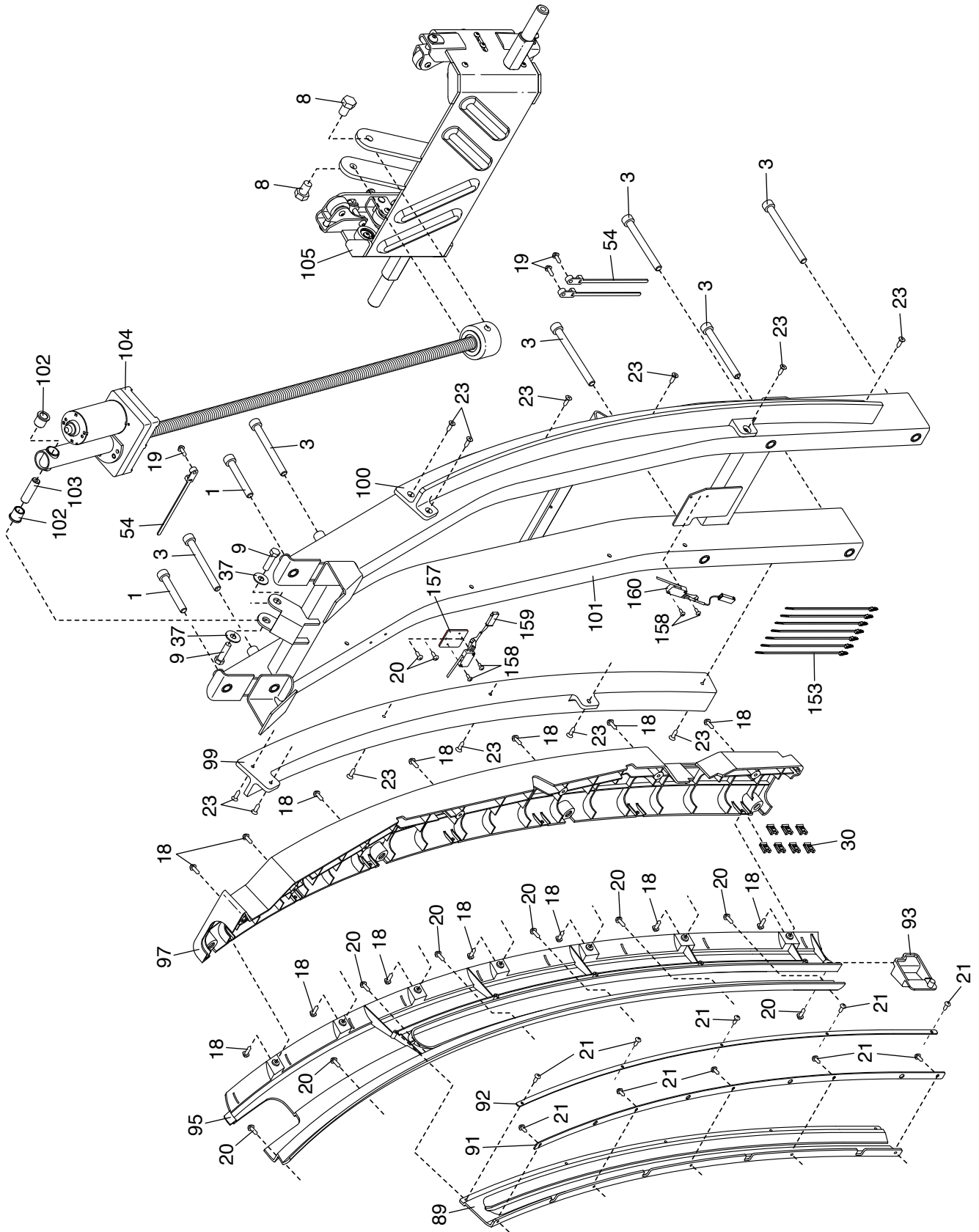

EXPLODED DRAWING D

Model No. NTL39222.2 R0922A

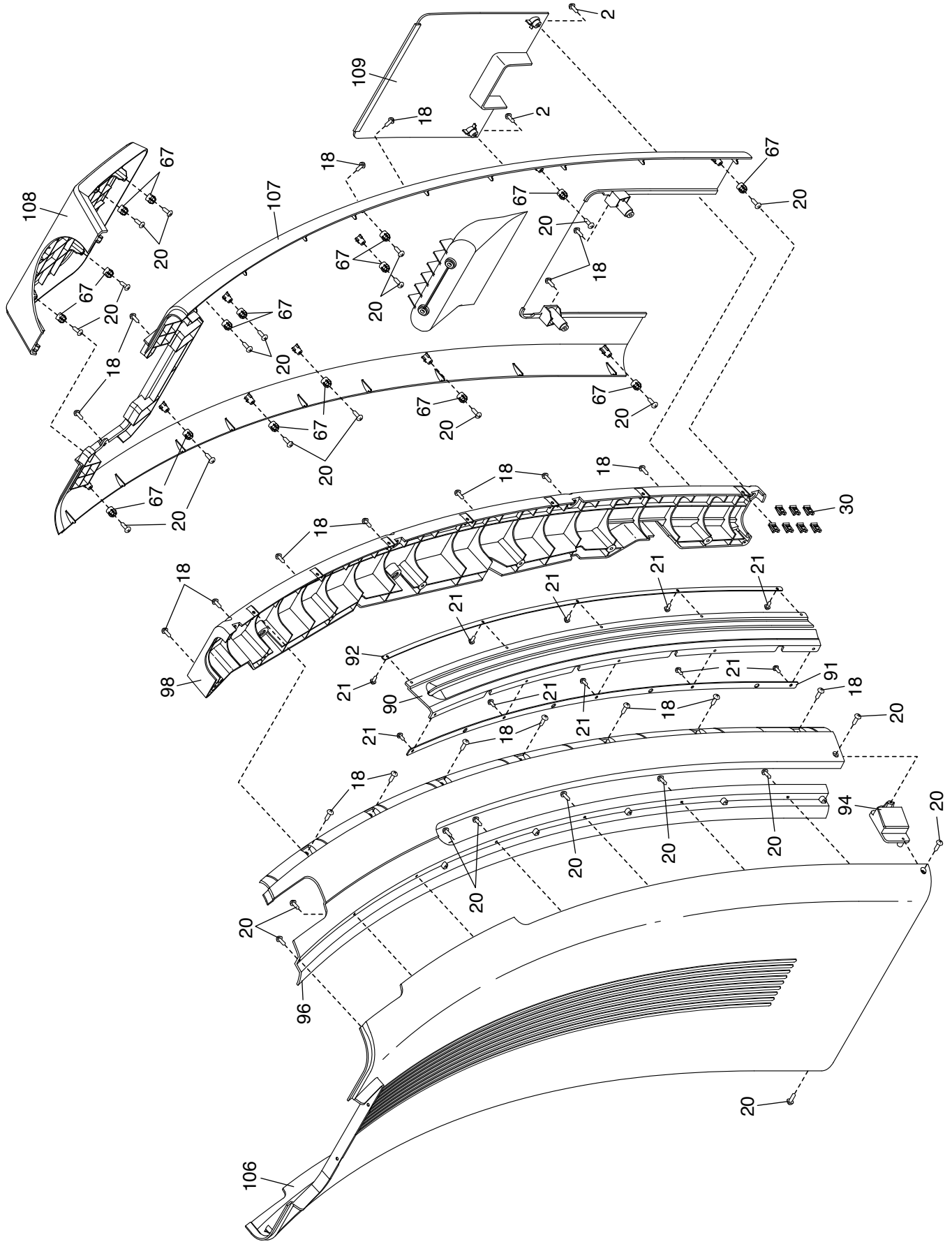

EXPLODED DRAWING E

Model No. NTL39222.2 R0922A

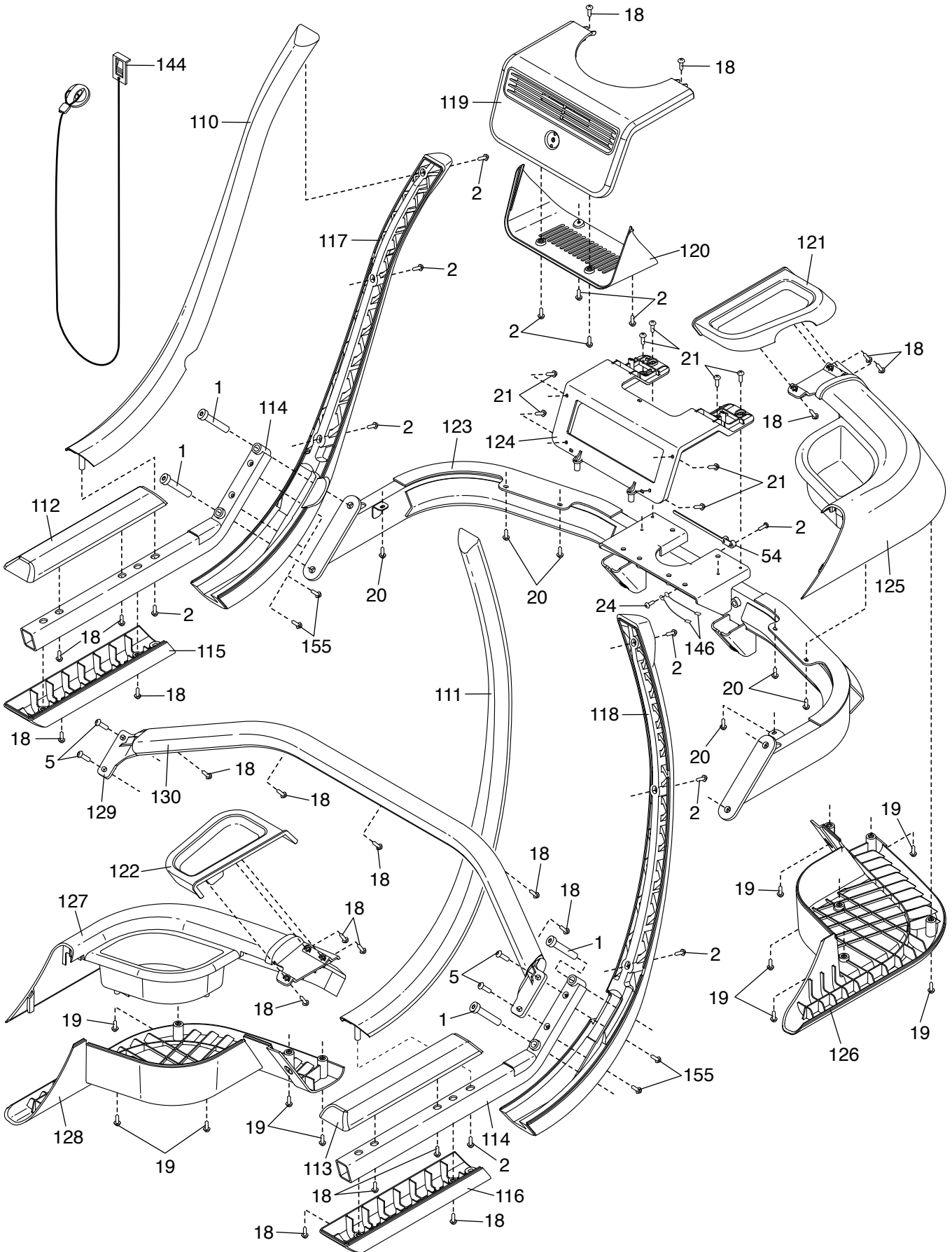

EXPLODED DRAWING F

Model No. NTL39222.2 R0922A

