

EXPLODED DRAWING A

Model No. NTL59417.5 R0418A

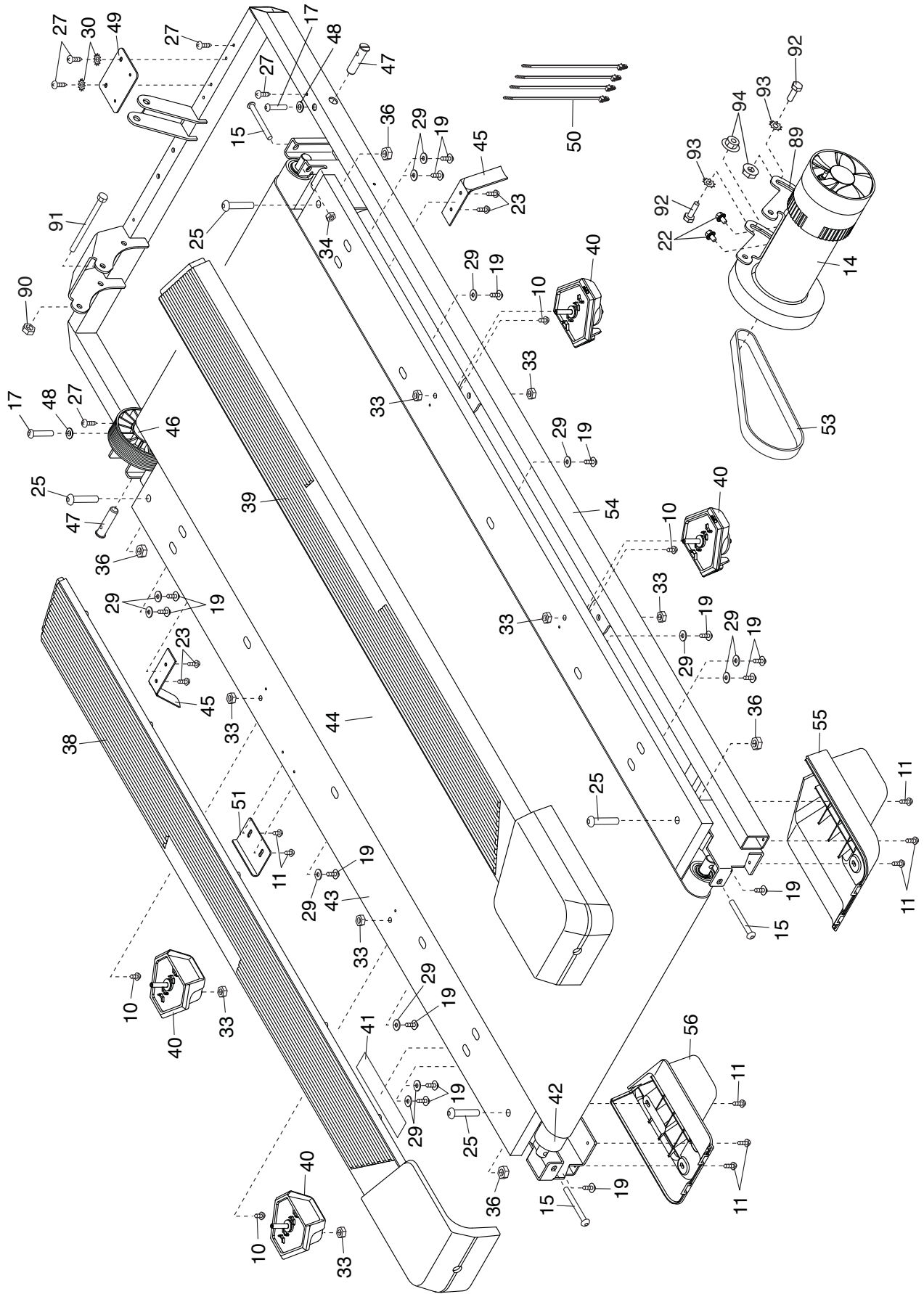

EXPLODED DRAWING B

Model No. NTL59417.5 R0418A

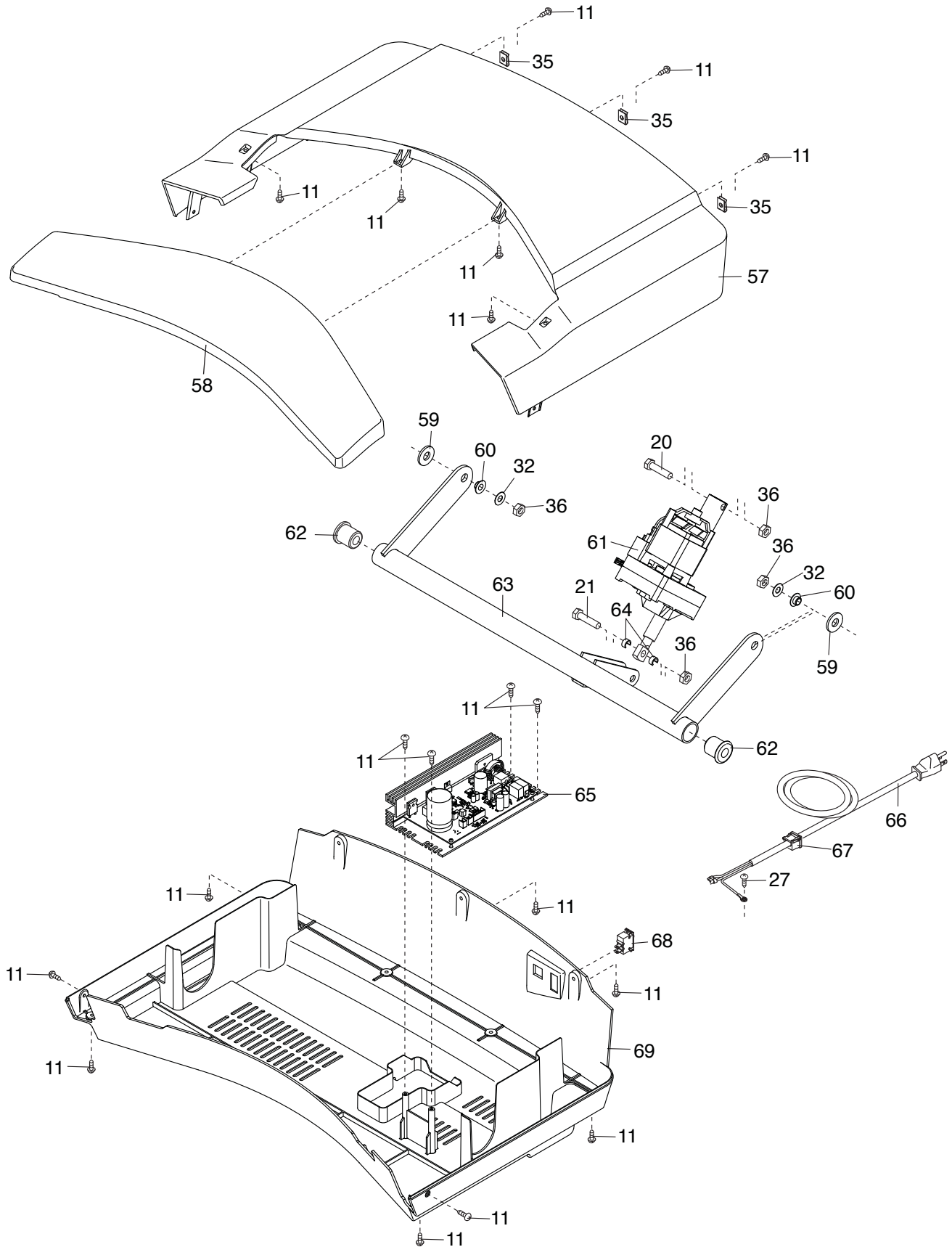

EXPLODED DRAWING D

Model No. NTL59417.5 R0418A

