

EXPLODED DRAWING A—Model No. NTL61009.1

R0110A

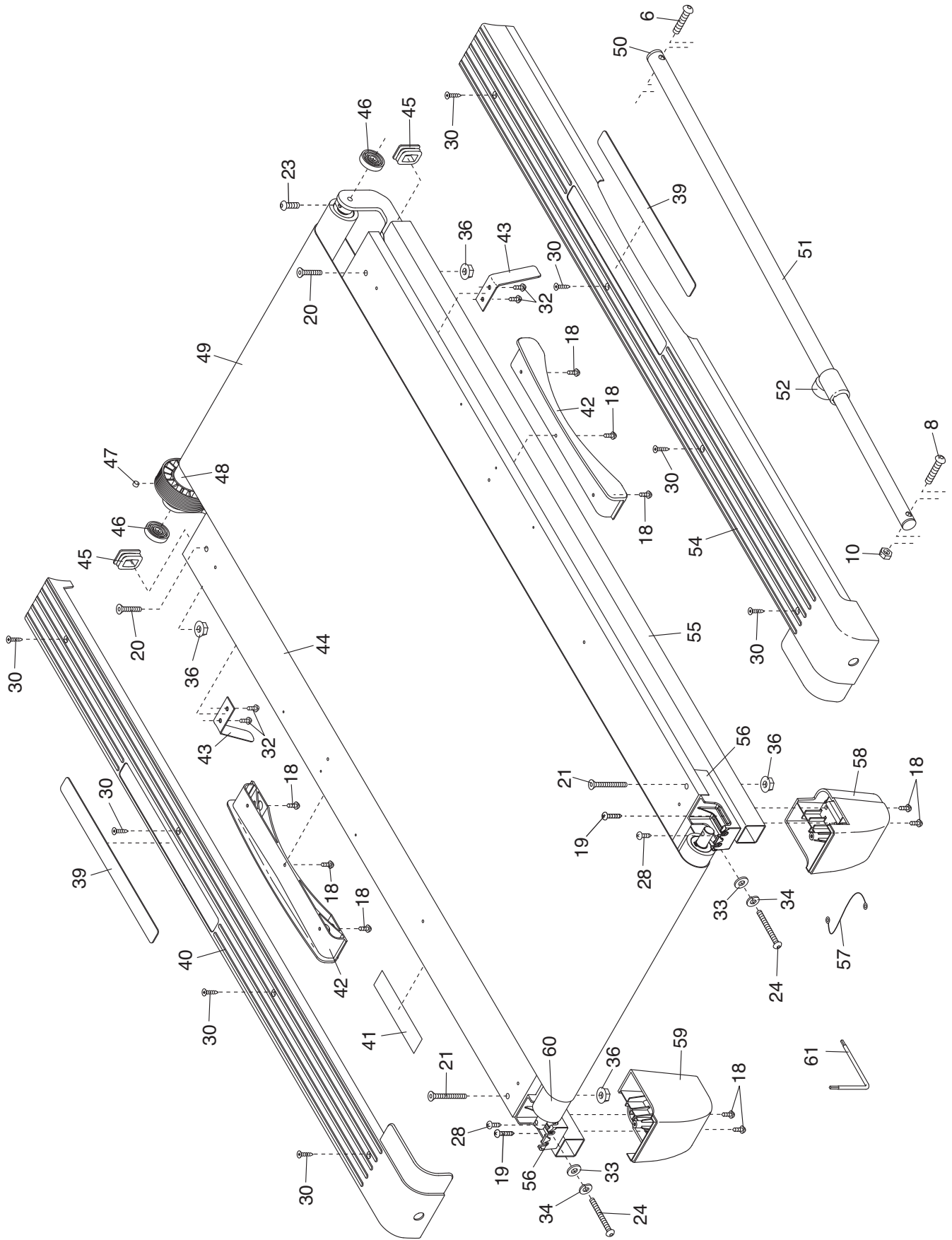

EXPLODED DRAWING B—Model No. NTL61009.1

R0110A

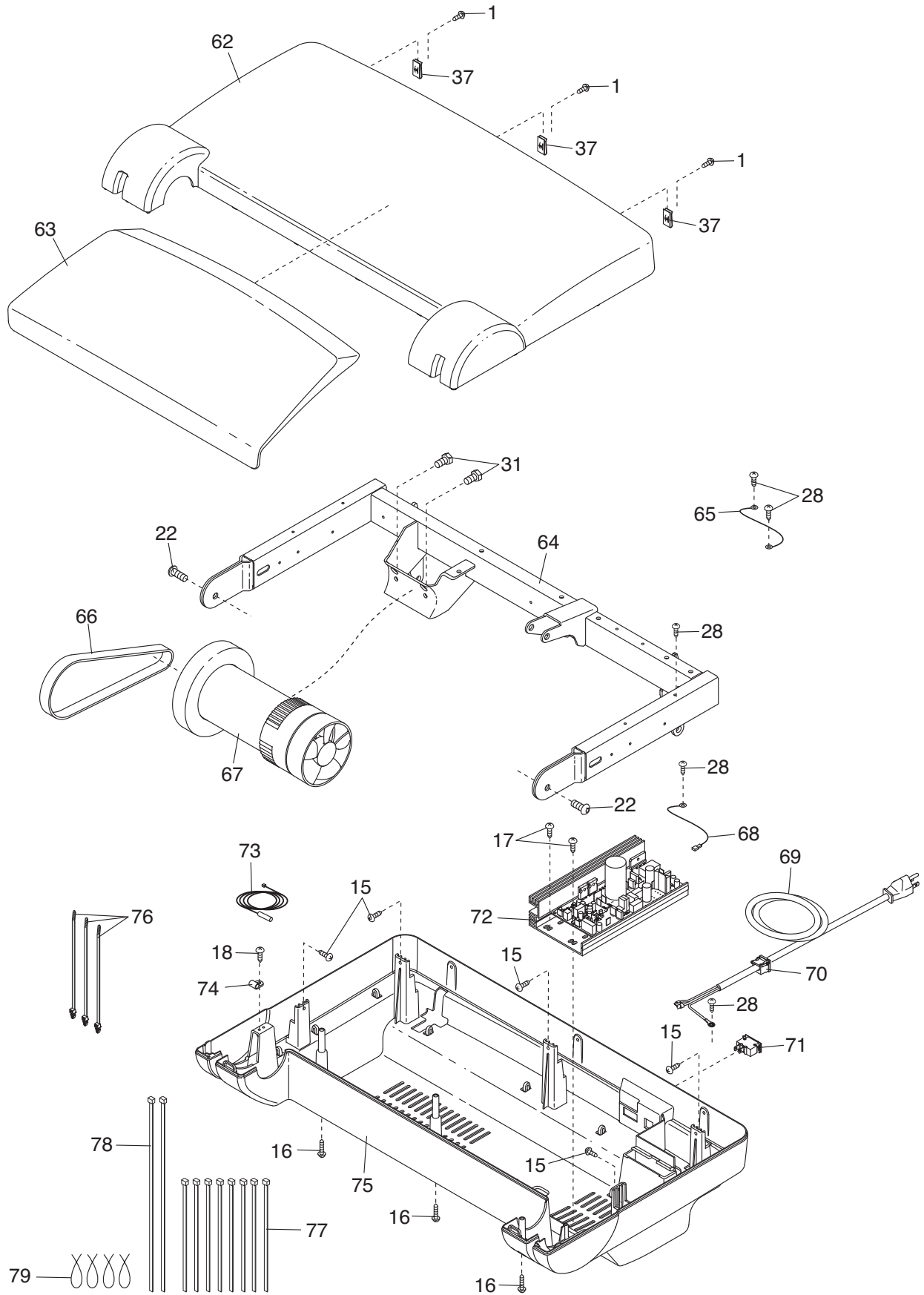

EXPLODED DRAWING C—Model No. NTL61009.1

R0110A

