

# EXPLODED DRAWING A

Model No. NTL61011.2 R0612A

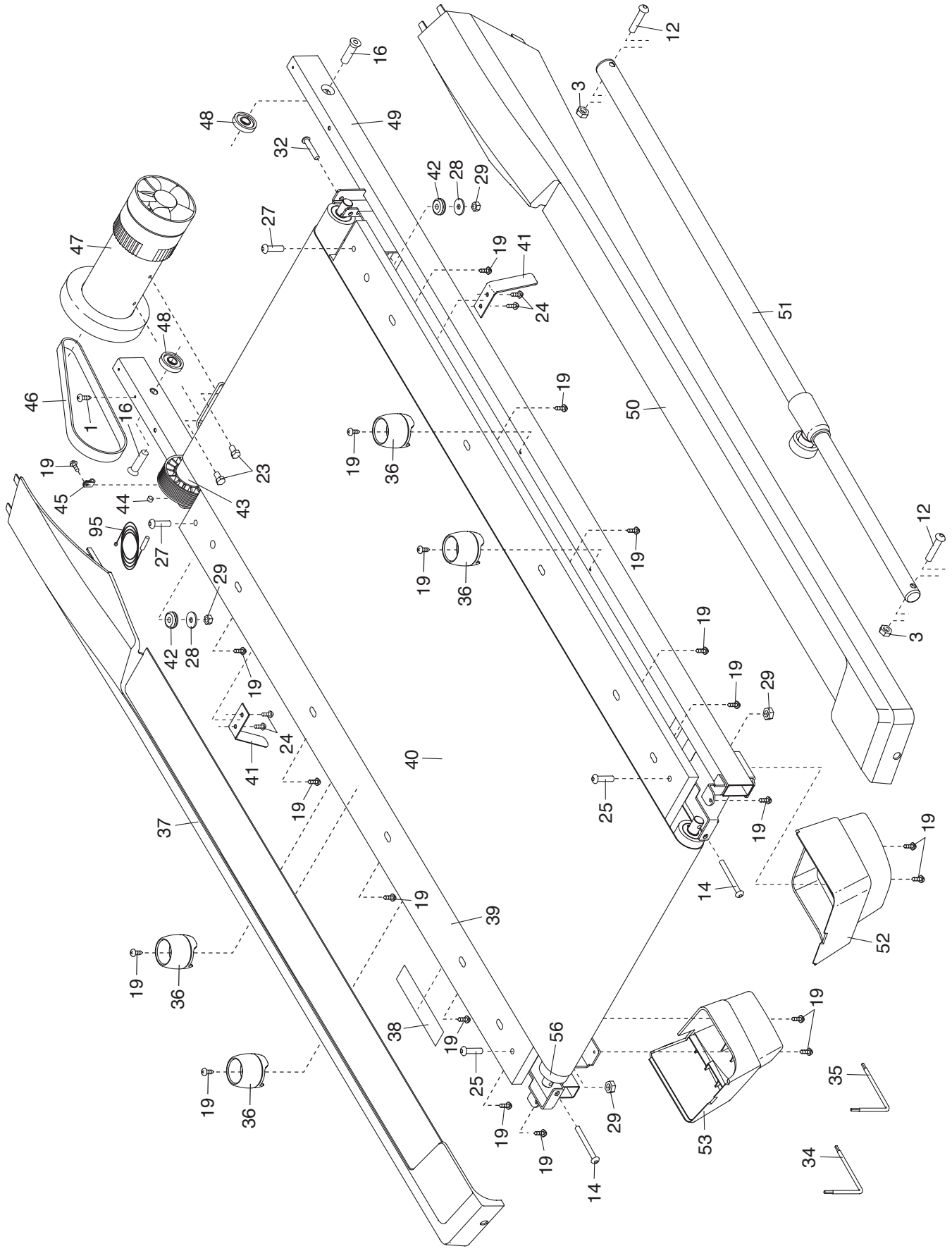

# EXPLODED DRAWING B

Model No. NTL61011.2 R0612A

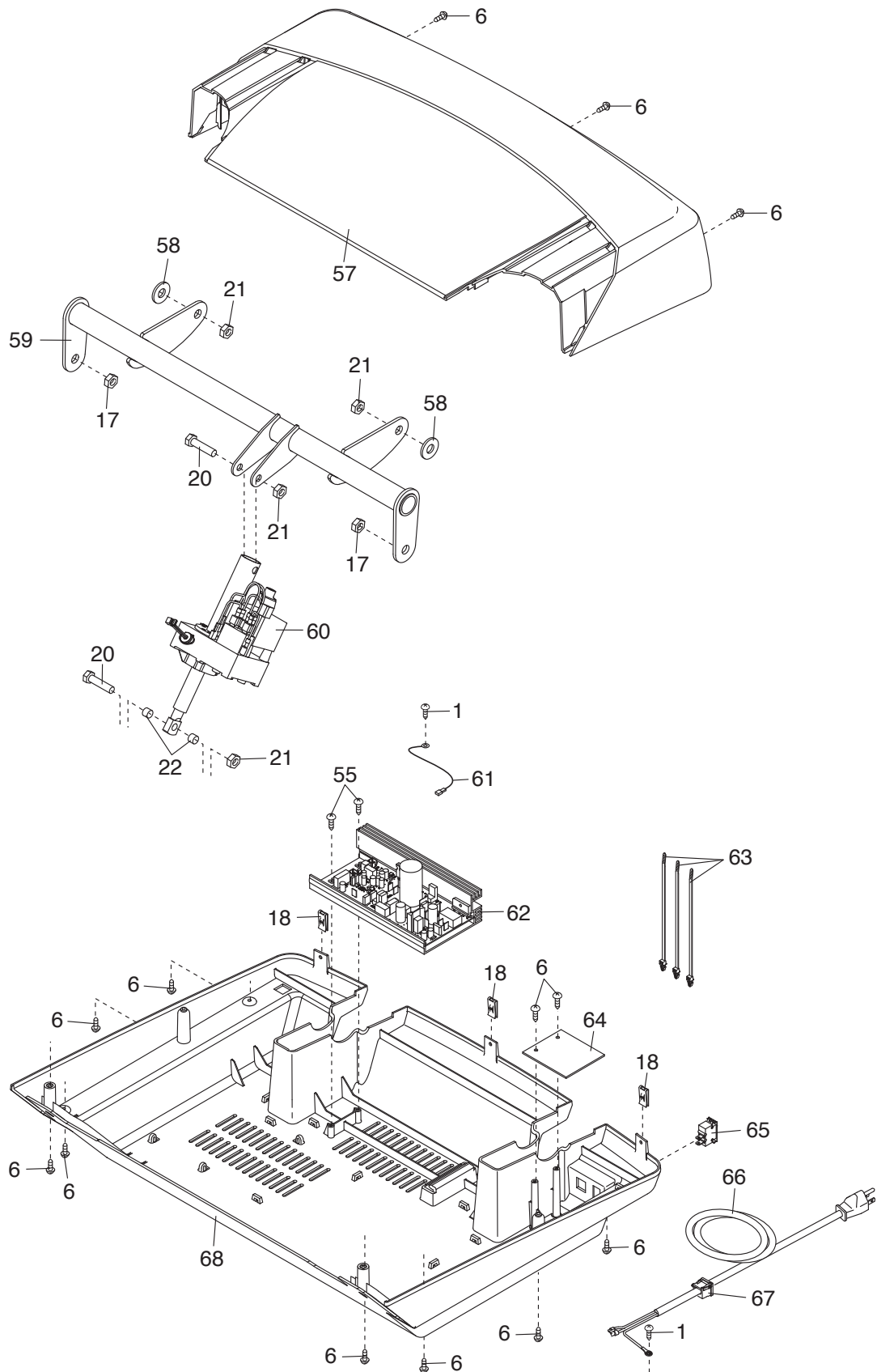

# EXPLODED DRAWING C

Model No. NTL61011.2 R0612A

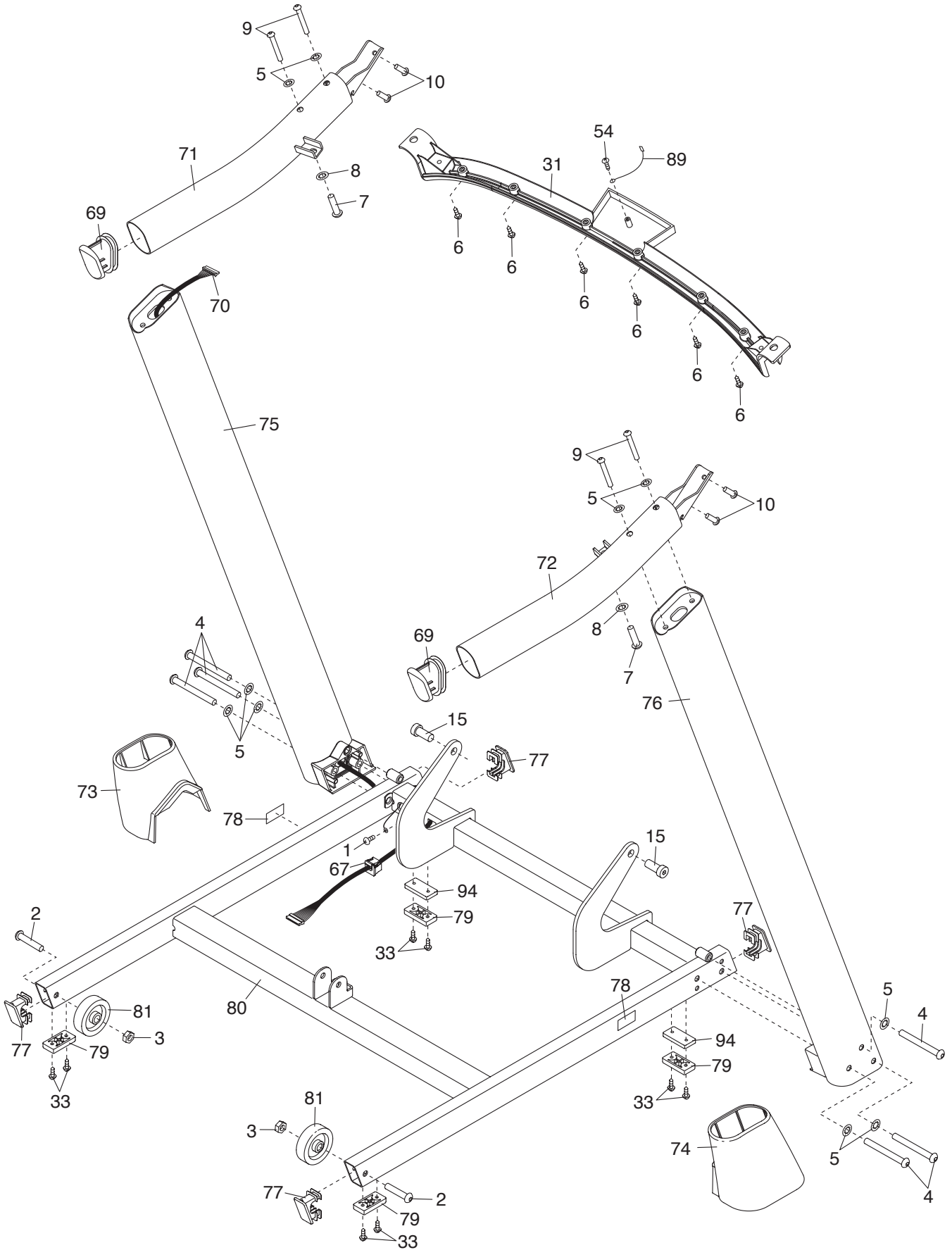

# EXPLODED DRAWING D

Model No. NTL61011.2 R0612A

