

# EXPLODED DRAWING A

Model No. NTL61011.3 R0513A

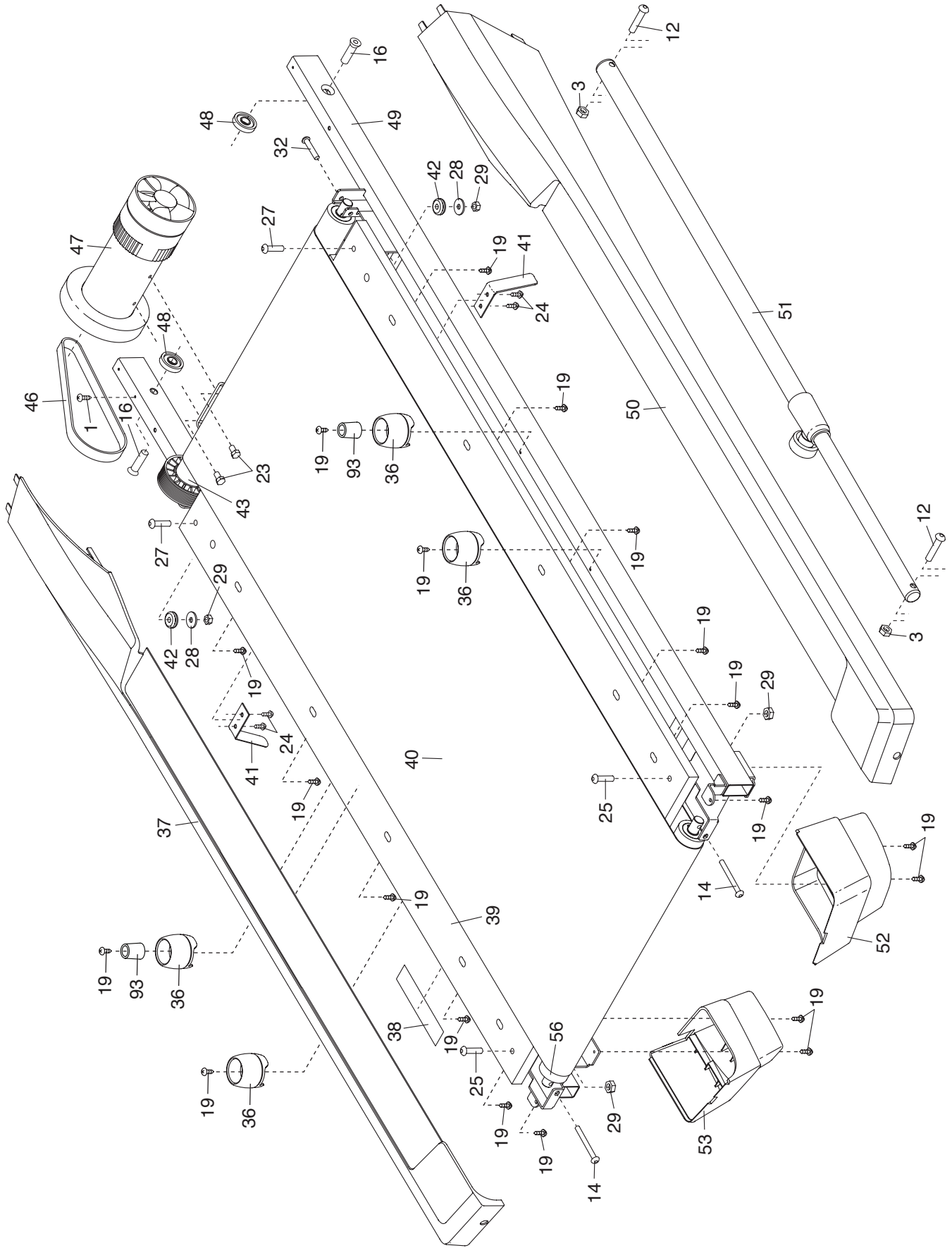

# EXPLODED DRAWING B

Model No. NTL61011.3 R0513A

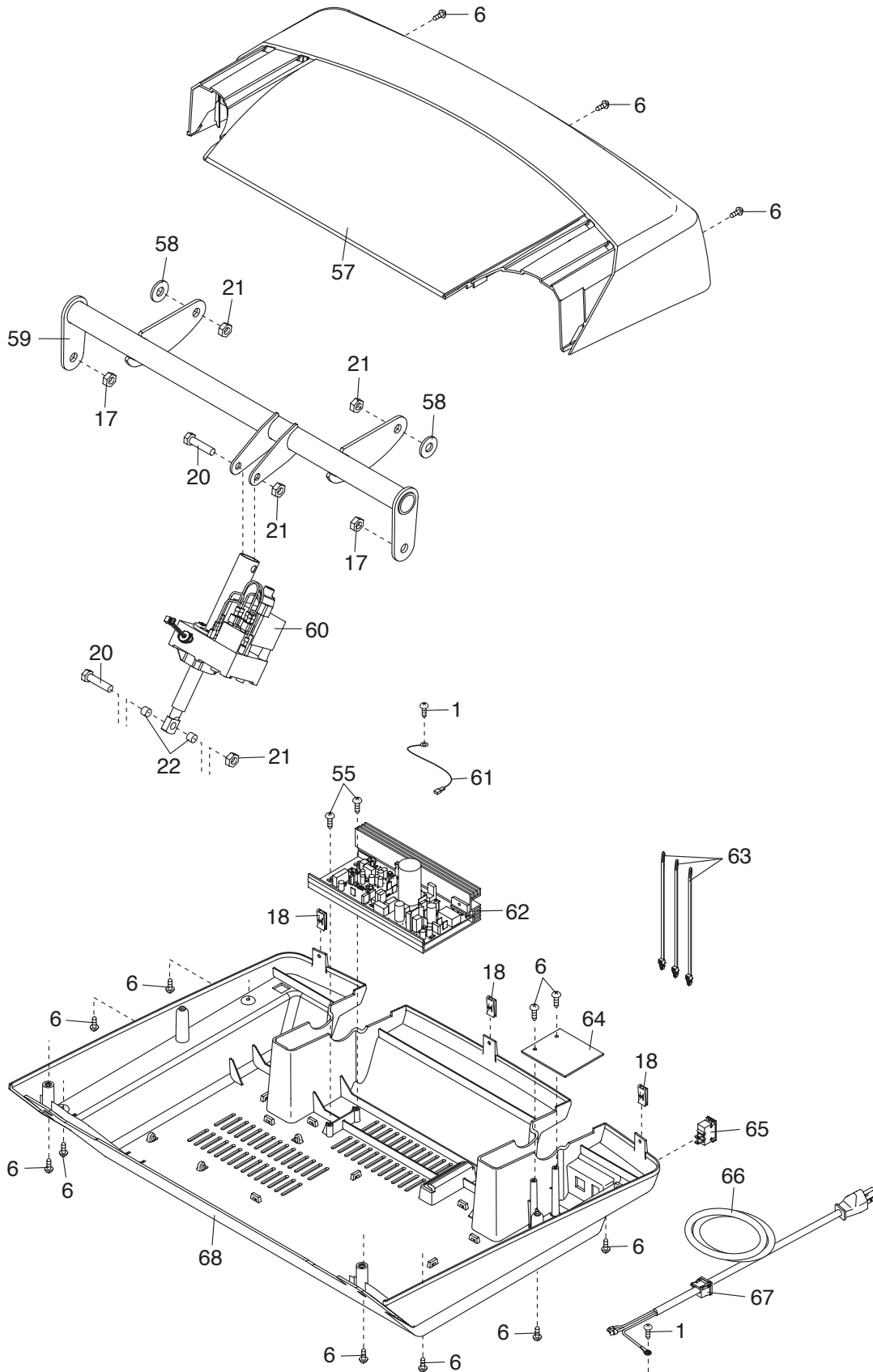

# EXPLODED DRAWING C

Model No. NTL61011.3 R0513A

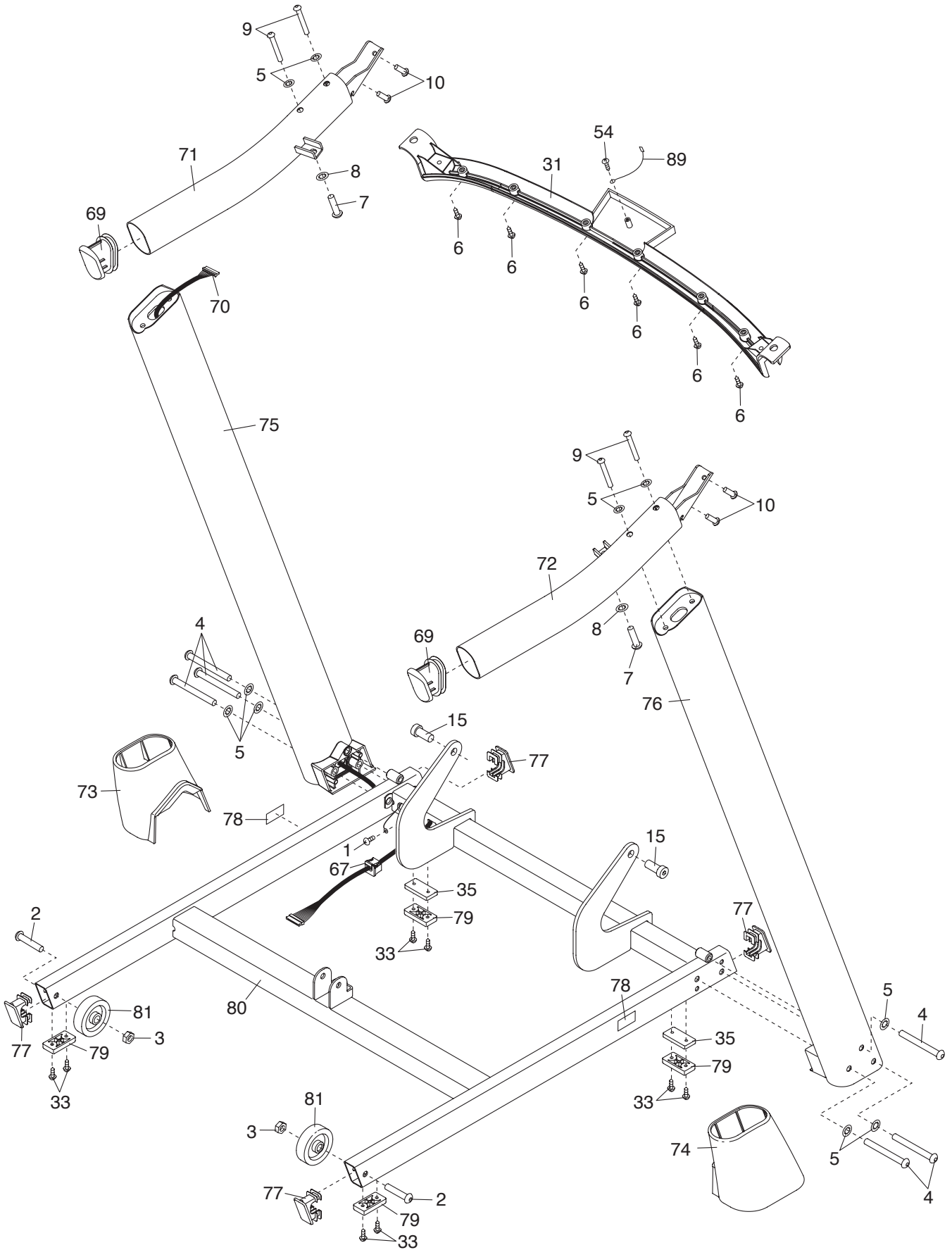

# EXPLODED DRAWING D

Model No. NTL61011.3 R0513A

