

EXPLODED DRAWING A

Model No. NTRW19422.4 R0222A

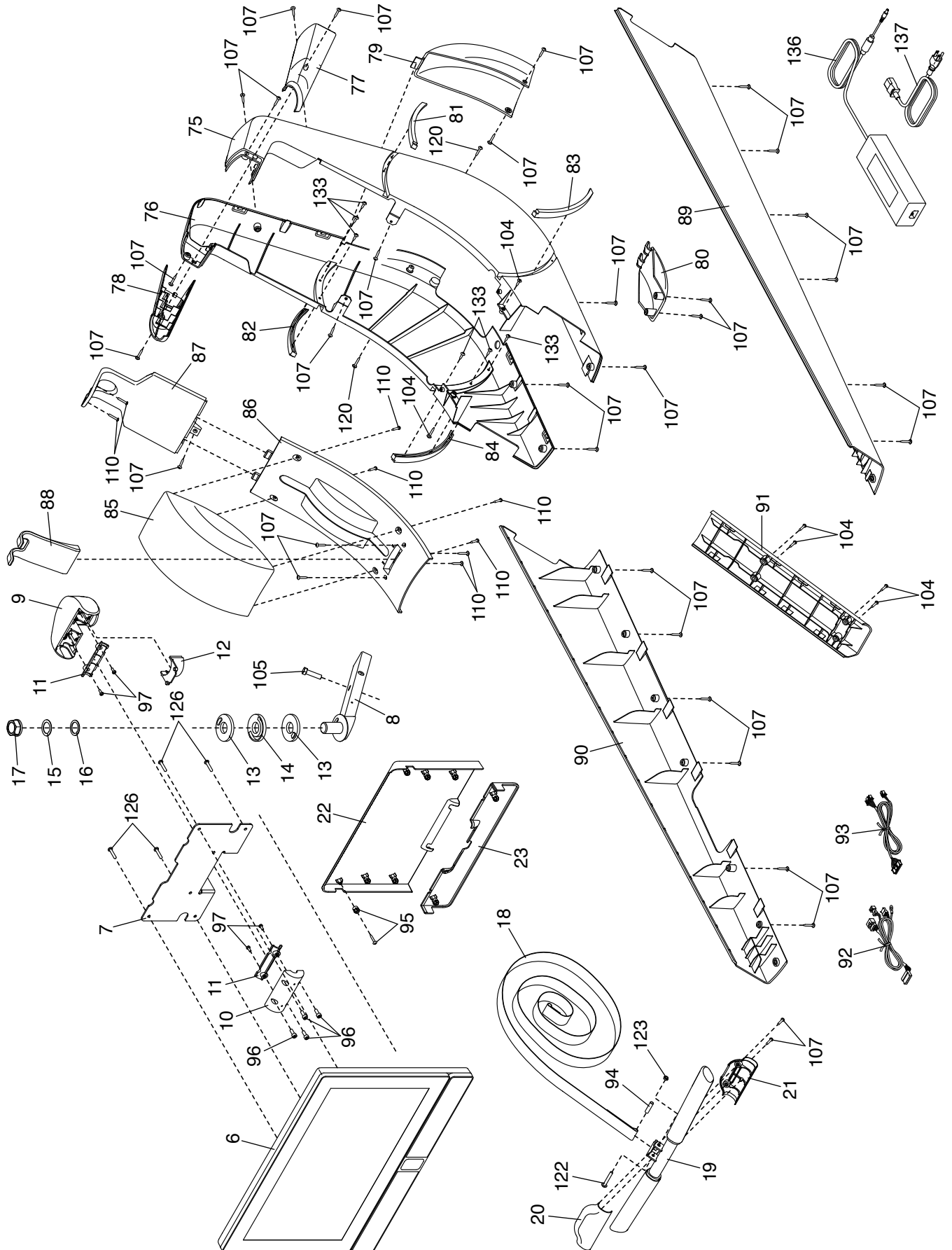

EXPLODED DRAWING B

Model No. NTRW19422.4 R0222A

