

EXPLODED DRAWING A

Model No. NTRW19423.1 R1122A

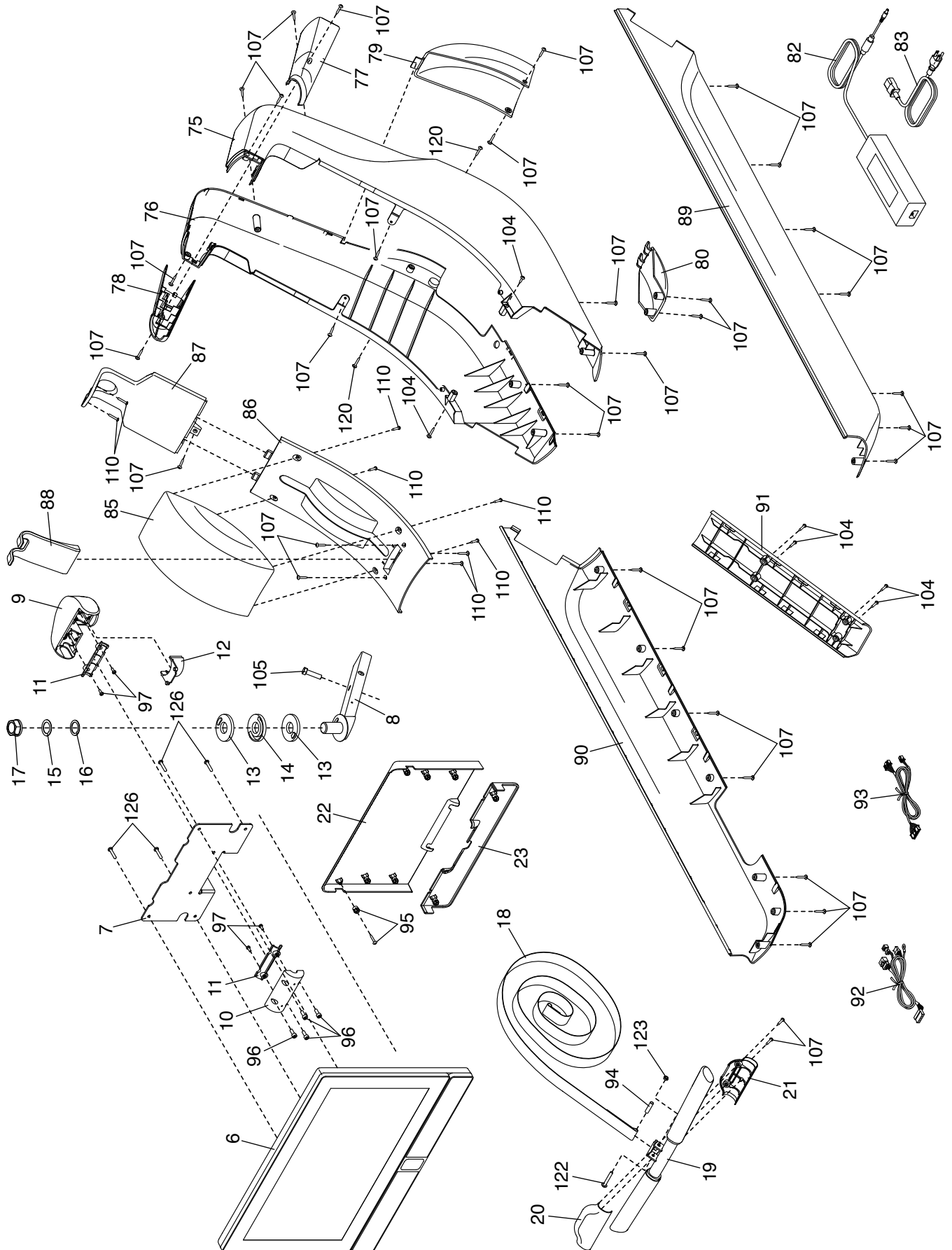

EXPLODED DRAWING B

Model No. NTRW19423.1 R1122A

