

EXPLODED DRAWING—Model No. NTTL11991

R0100A

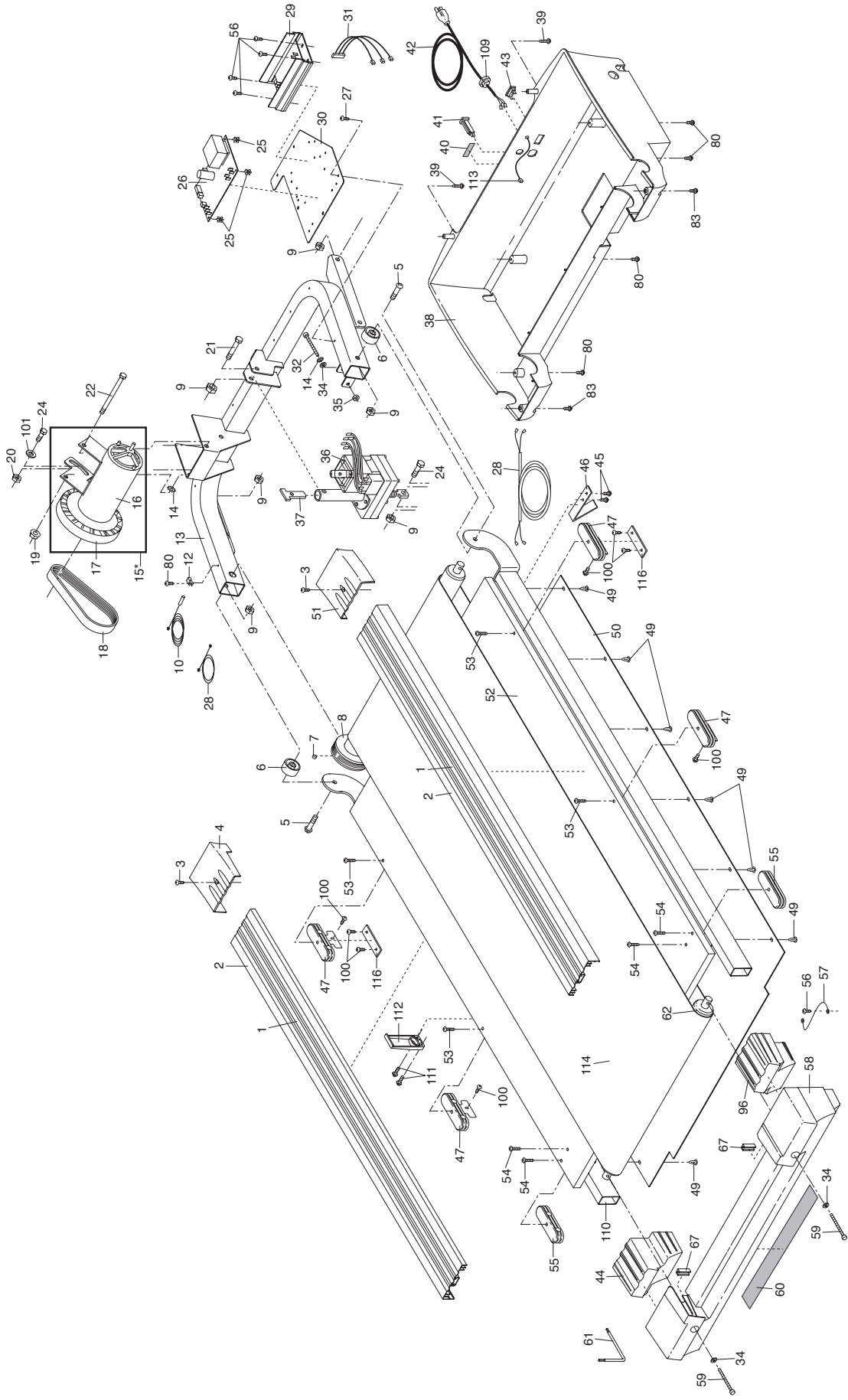

EXPLODED DRAWING—Model No. NTTL11991

R0100A

