

EXPLODED DRAWING B—Model No. PATL41106.0

R0906A

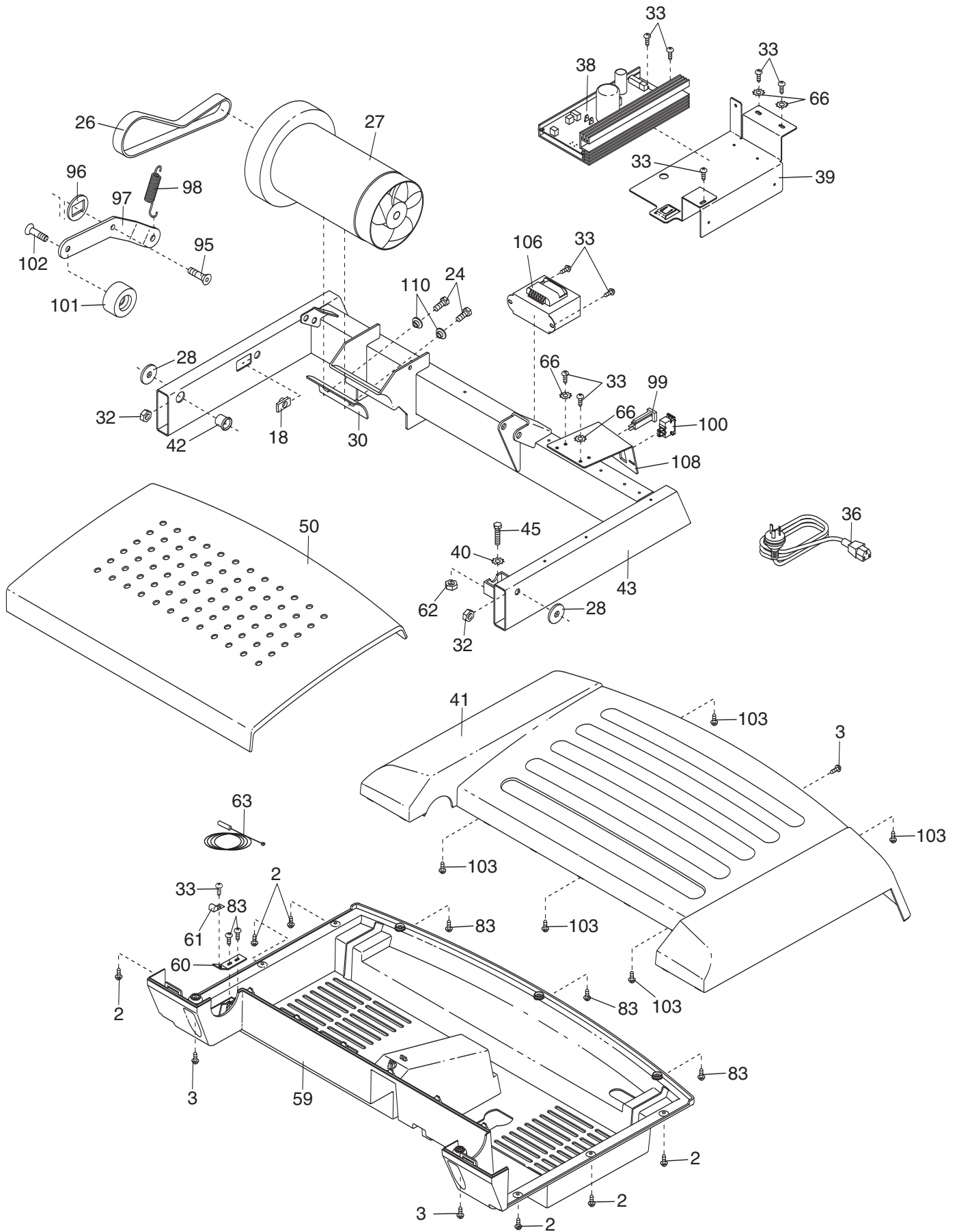

EXPLODED DRAWING C—Model No. PATL41106.0

R0906A

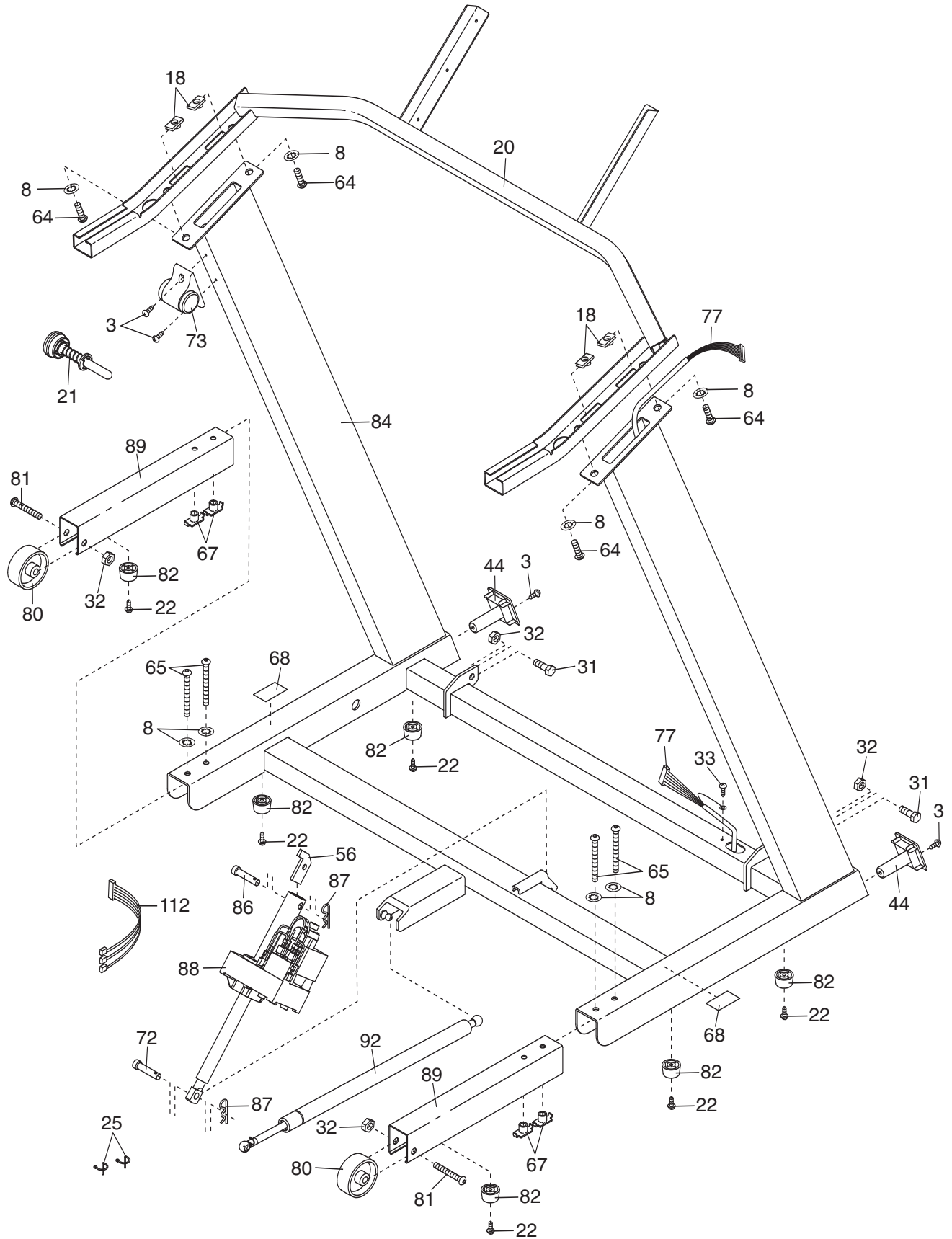

EXPLODED DRAWING D—Model No. PATL41106.0

R0906A

