

EXPLODED DRAWING B

Model No. PETL10714.0 R0114A

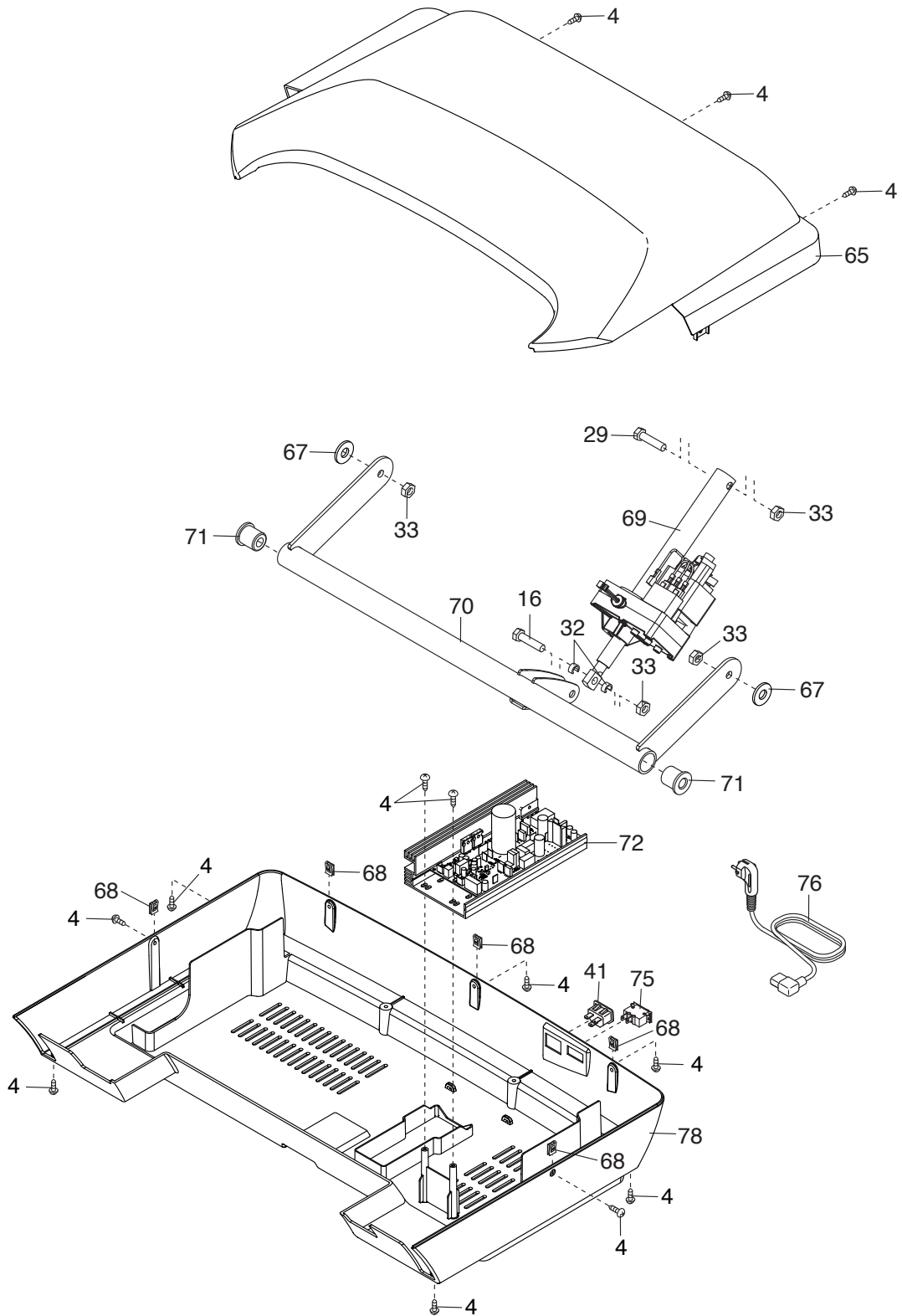

EXPLODED DRAWING C

Model No. PETL10714.0 R0114A

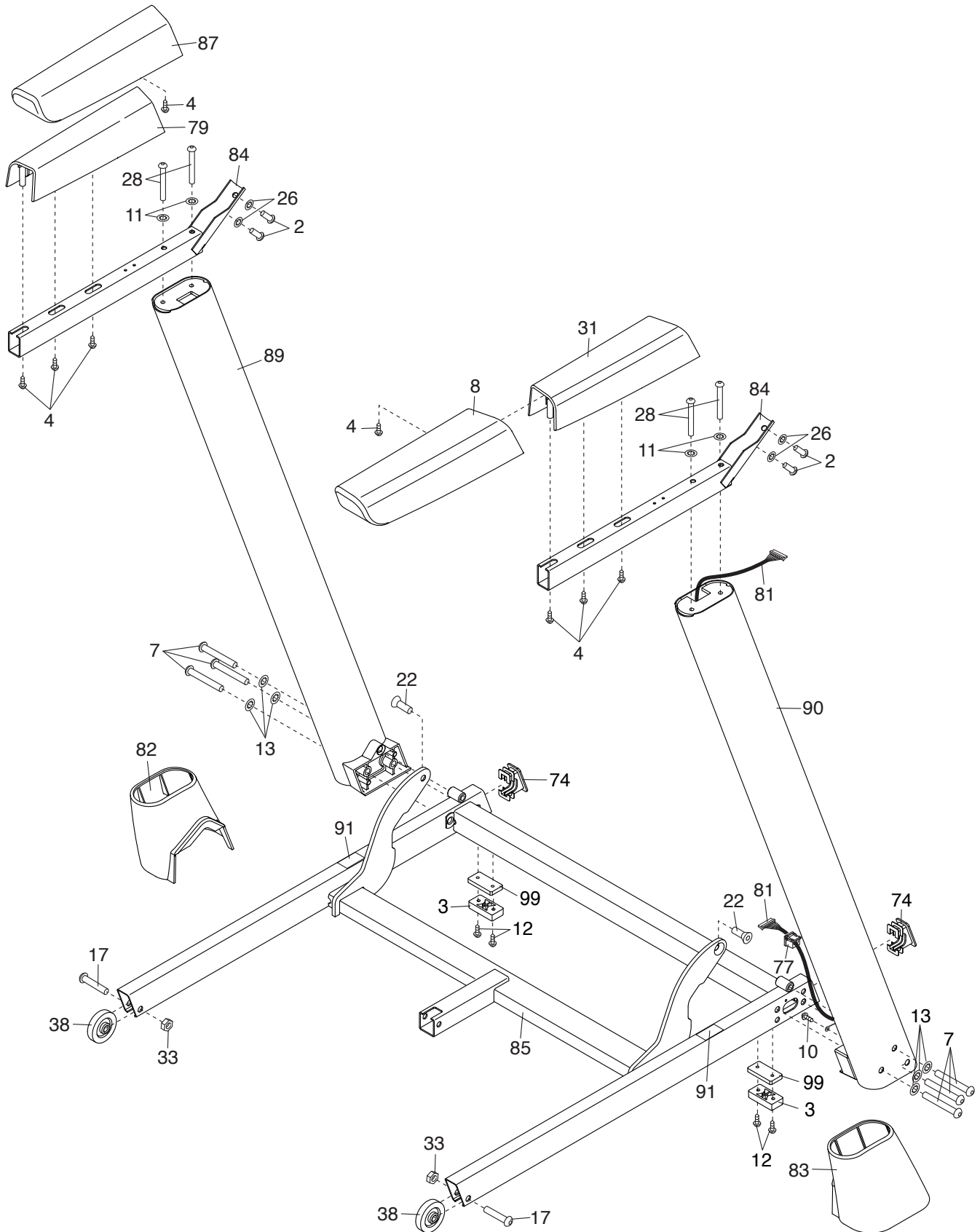

EXPLODED DRAWING D

Model No. PETL10714.0 R0114A

