

EXPLODED DRAWING A

Model No. PETL11711.1 R0112A

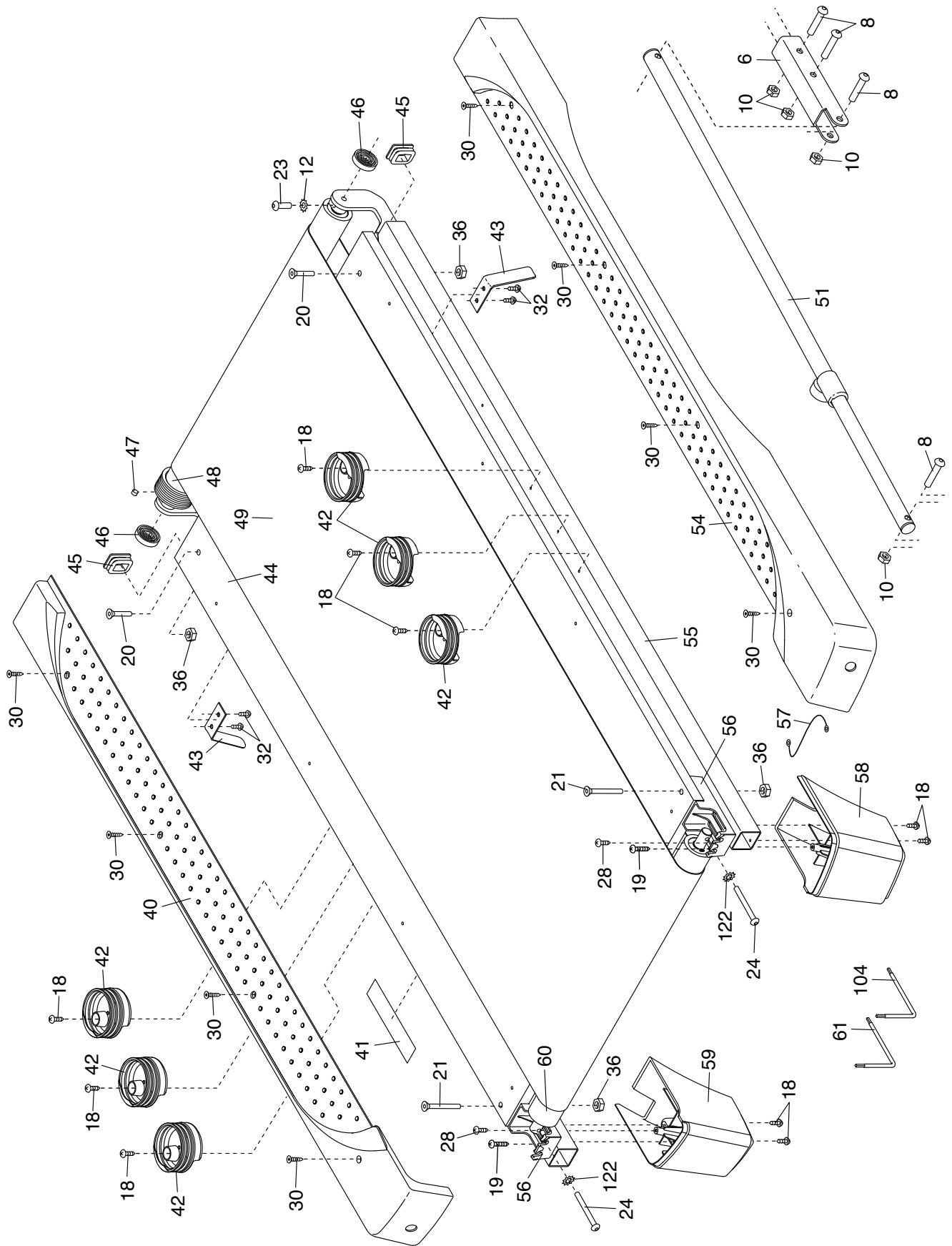

EXPLODED DRAWING B

Model No. PETL11711.1 R0112A

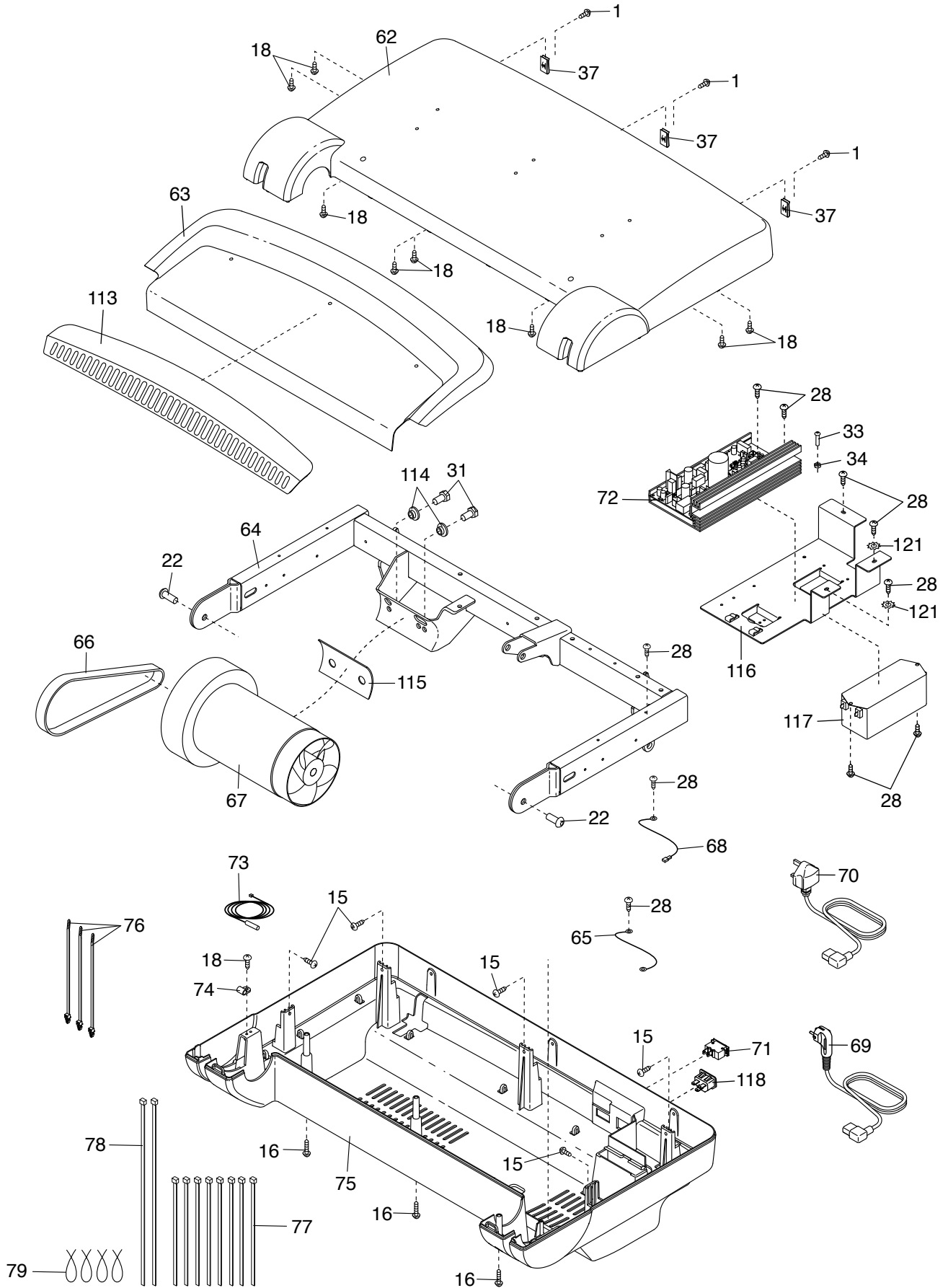

EXPLODED DRAWING C

Model No. PETL11711.1 R0112A

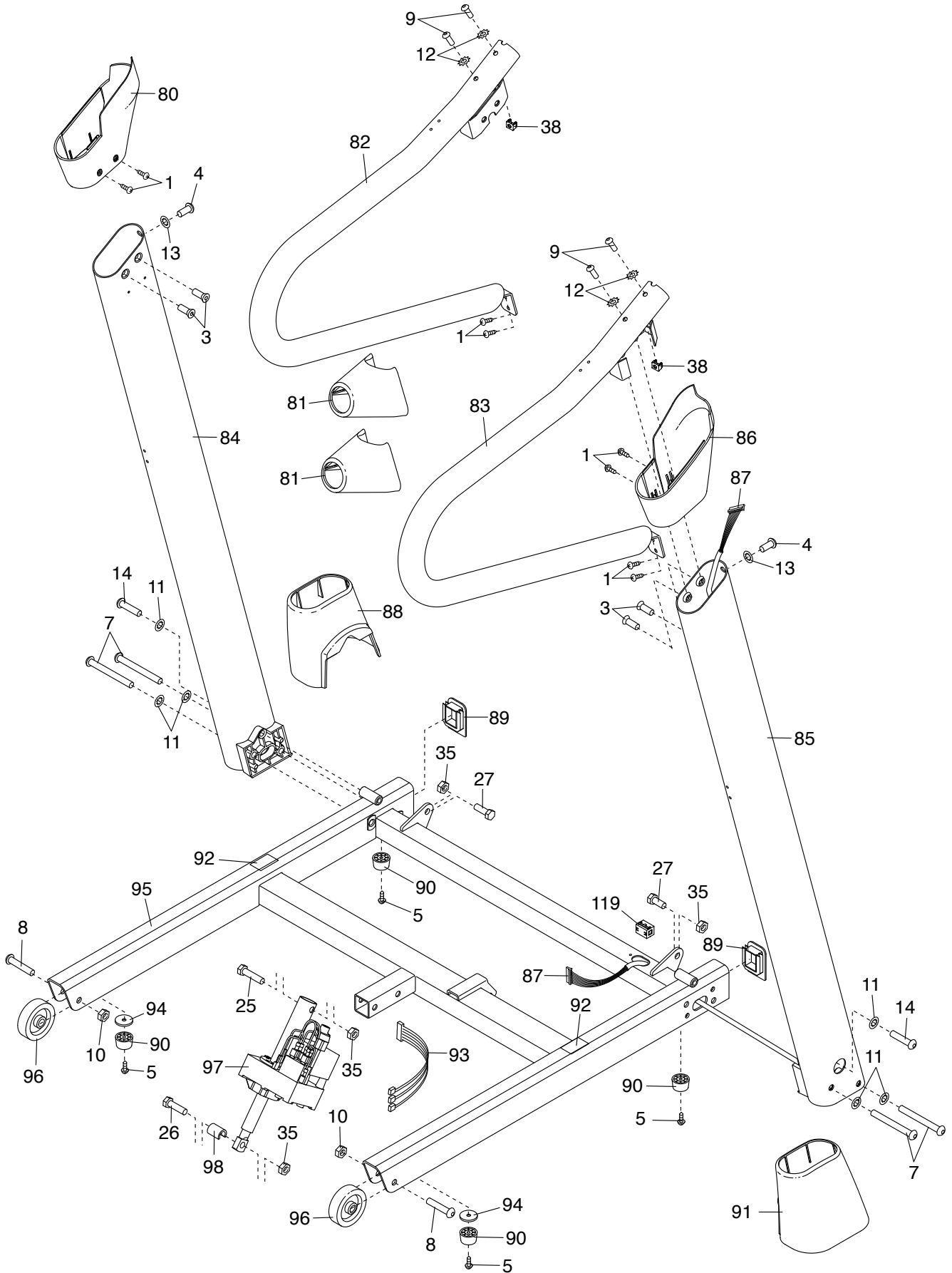

EXPLODED DRAWING D

Model No. PETL11711.1 R0112A

