

EXPLODED DRAWING A

Model No. PETL12711.0 R0511A

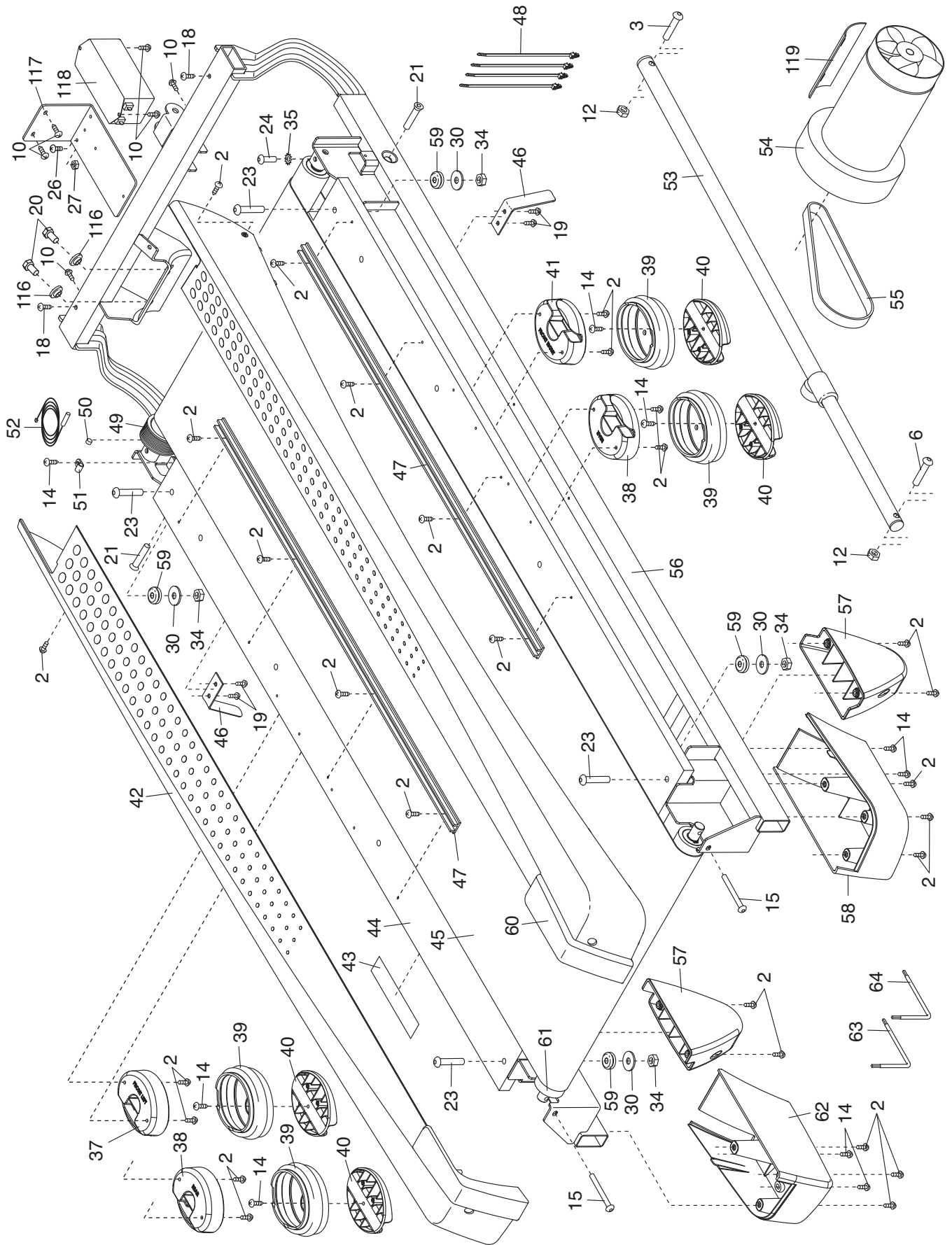

EXPLODED DRAWING B

Model No. PETL12711.0 R0511A

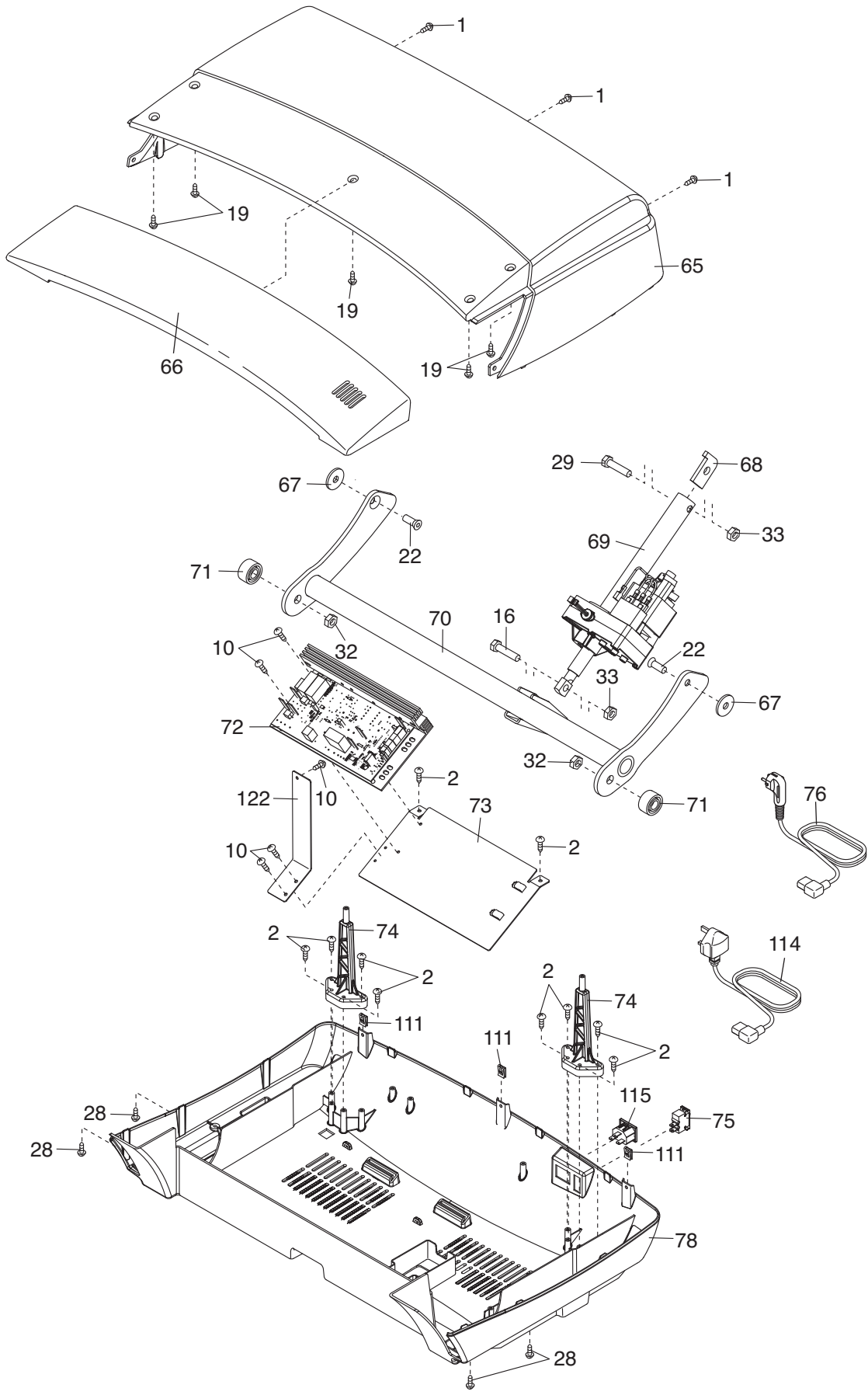

EXPLODED DRAWING C

Model No. PETL12711.0 R0511A

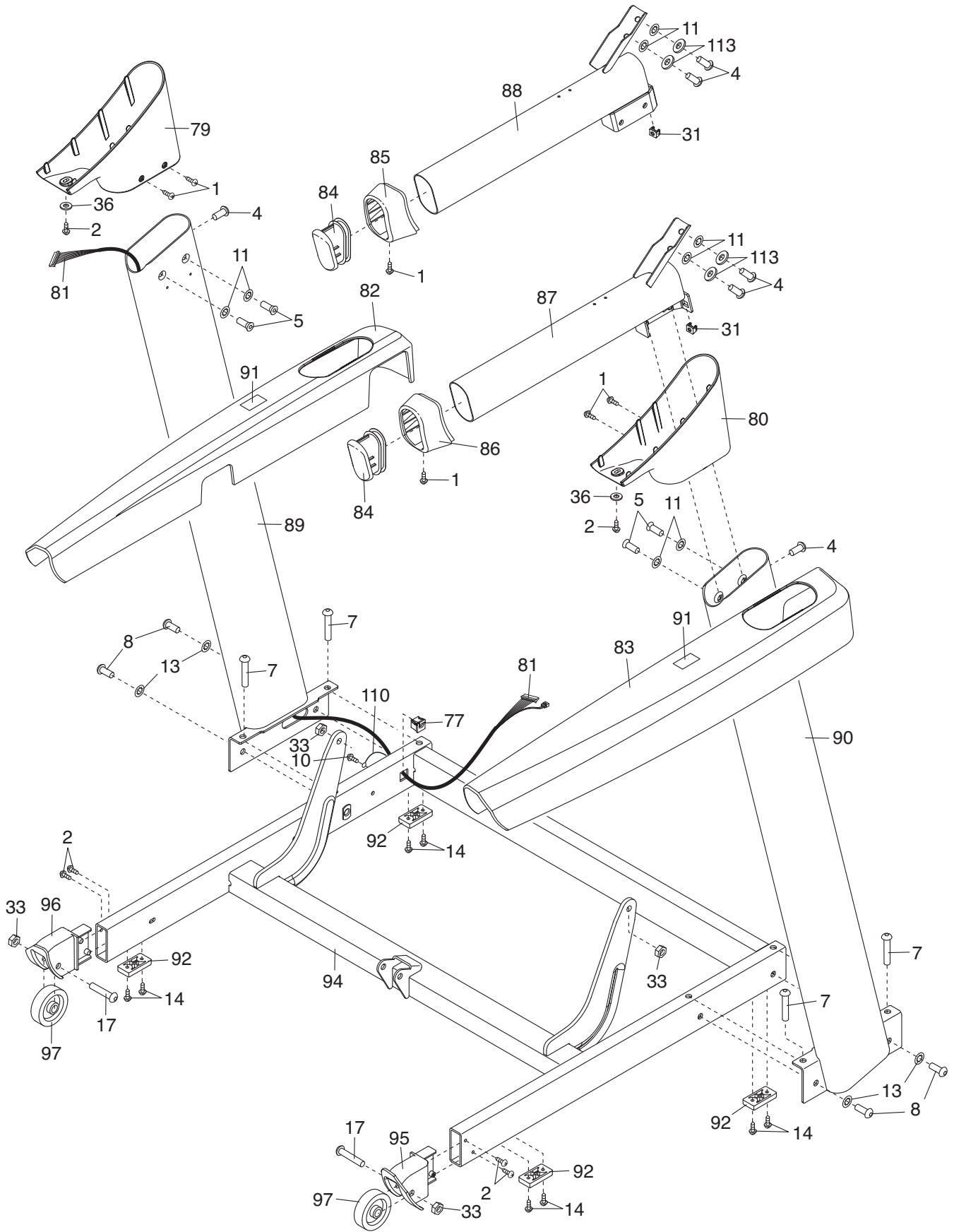

EXPLODED DRAWING D

Model No. PETL12711.0 R0511A

