

EXPLODED DRAWING A

Model No. PETL12713.0 R0513B

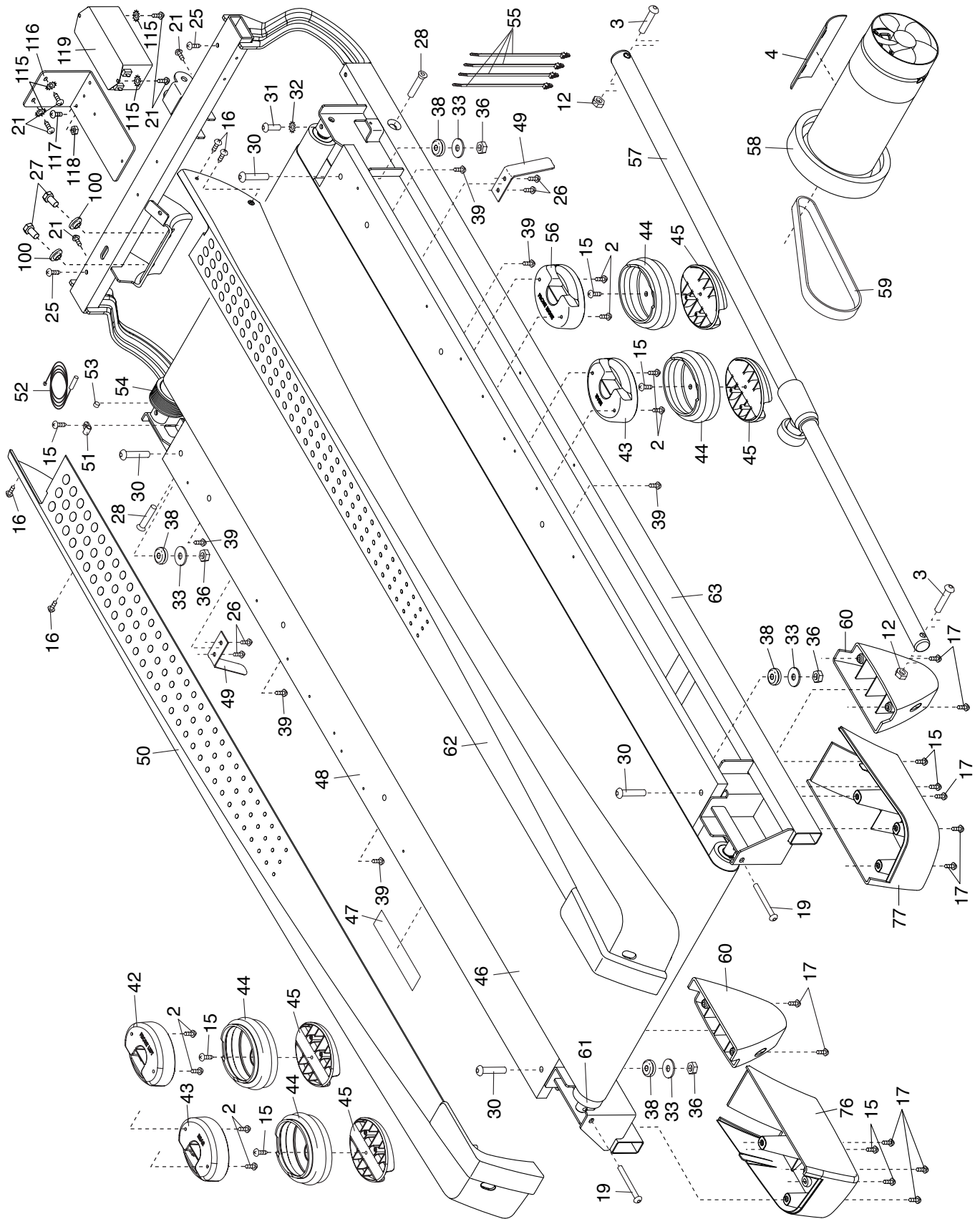

EXPLODED DRAWING B

Model No. PETL12713.0 R0513B

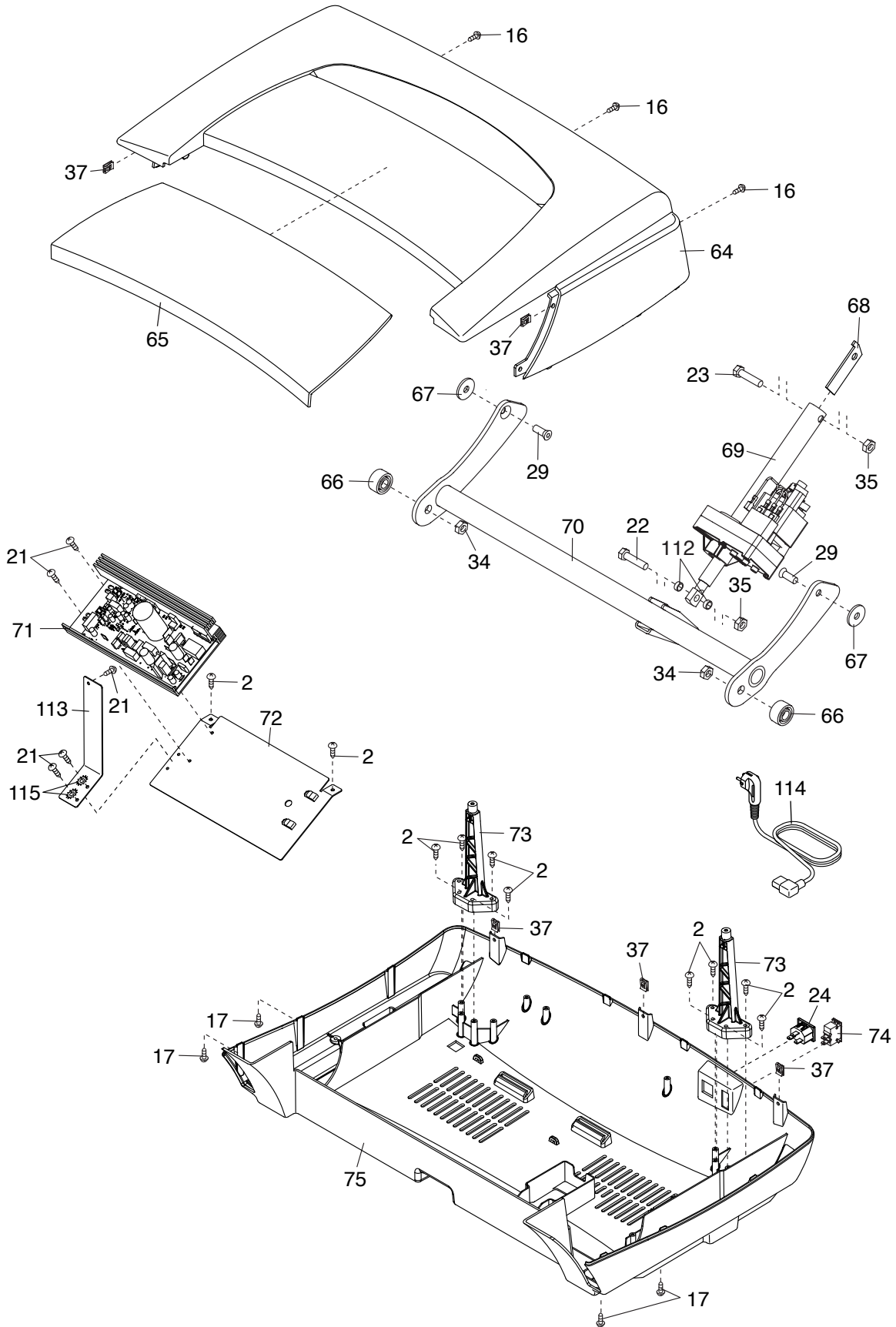

EXPLODED DRAWING D

Model No. PETL12713.0 R0513B

