

EXPLODED DRAWING A

Model No. PETL12714.0 R0114A

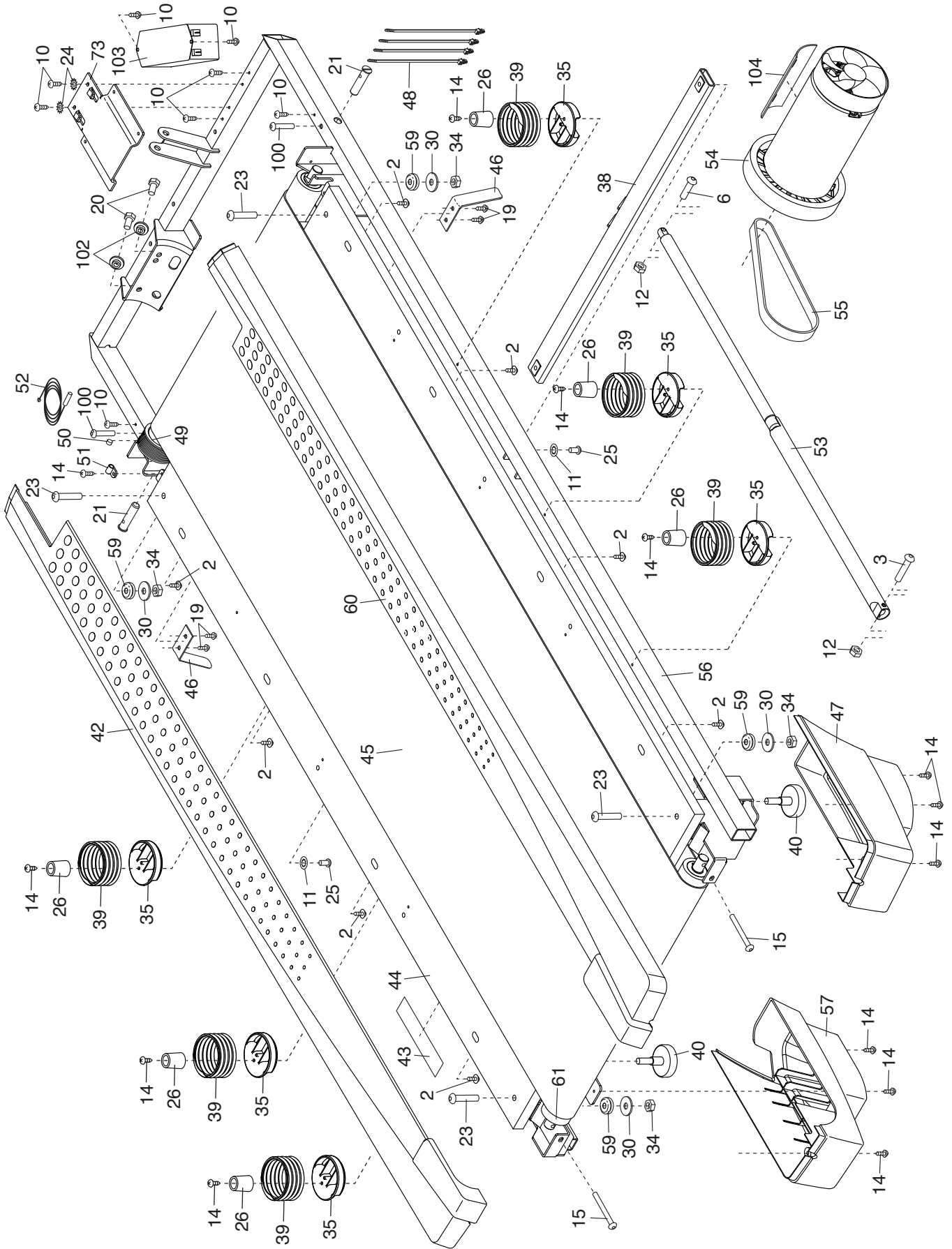

EXPLODED DRAWING B

Model No. PETL12714.0 R0114A

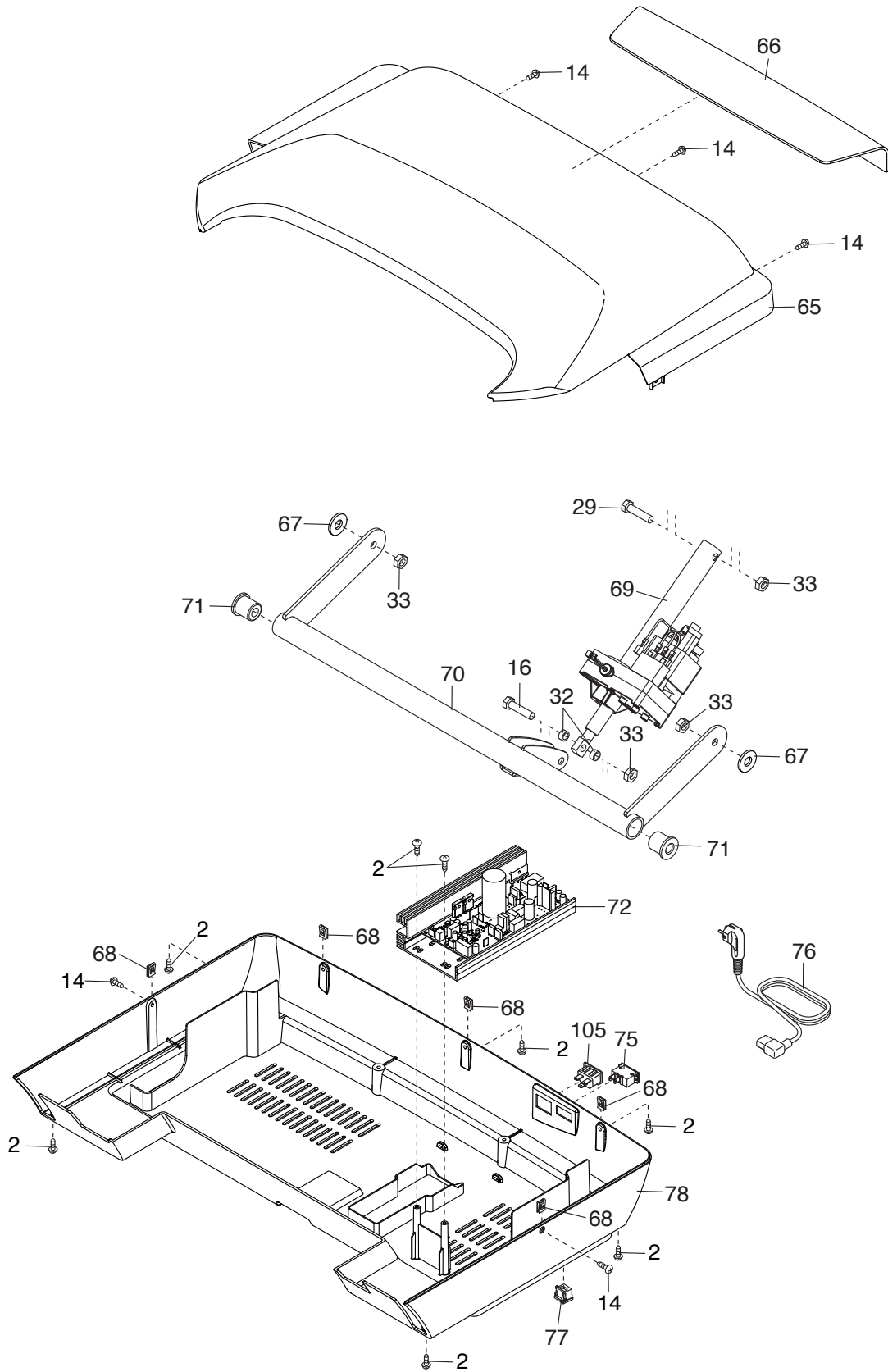

EXPLODED DRAWING C

Model No. PETL12714.0 R0114A

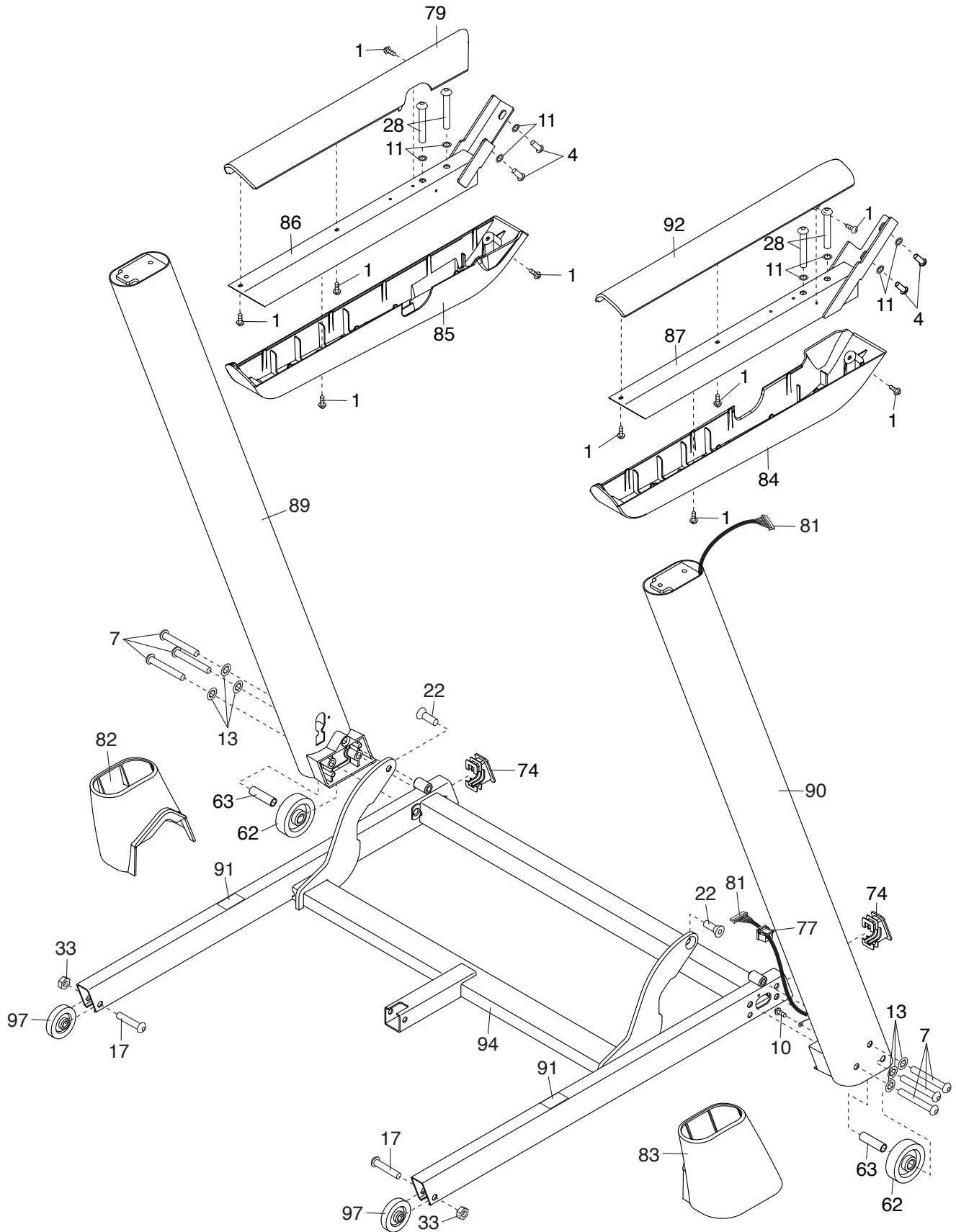

EXPLODED DRAWING D

Model No. PETL12714.0 R0114A

