

# EXPLODED DRAWING A

Model No. PETL12714.1 R0514A

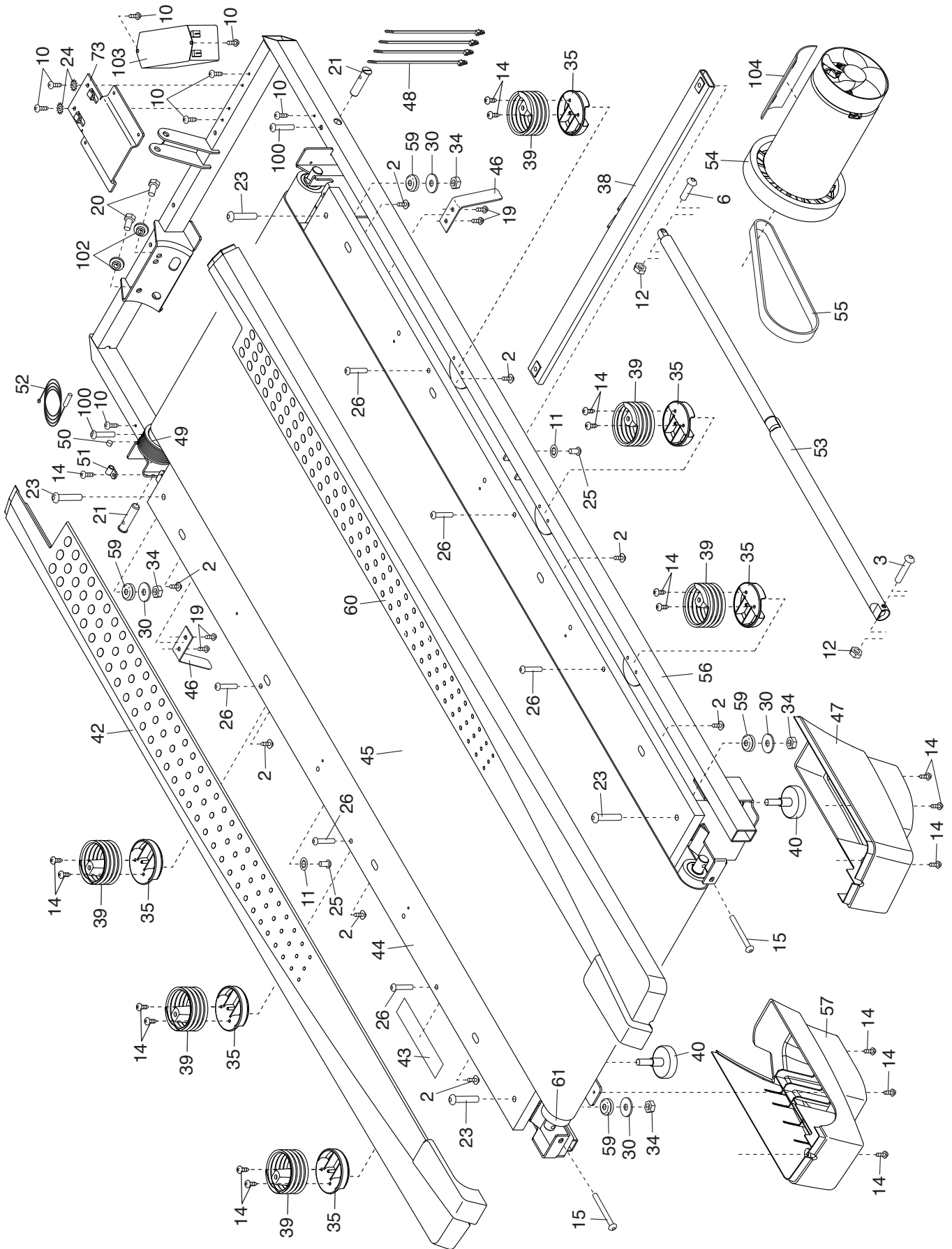

# EXPLODED DRAWING B

Model No. PETL12714.1 R0514A

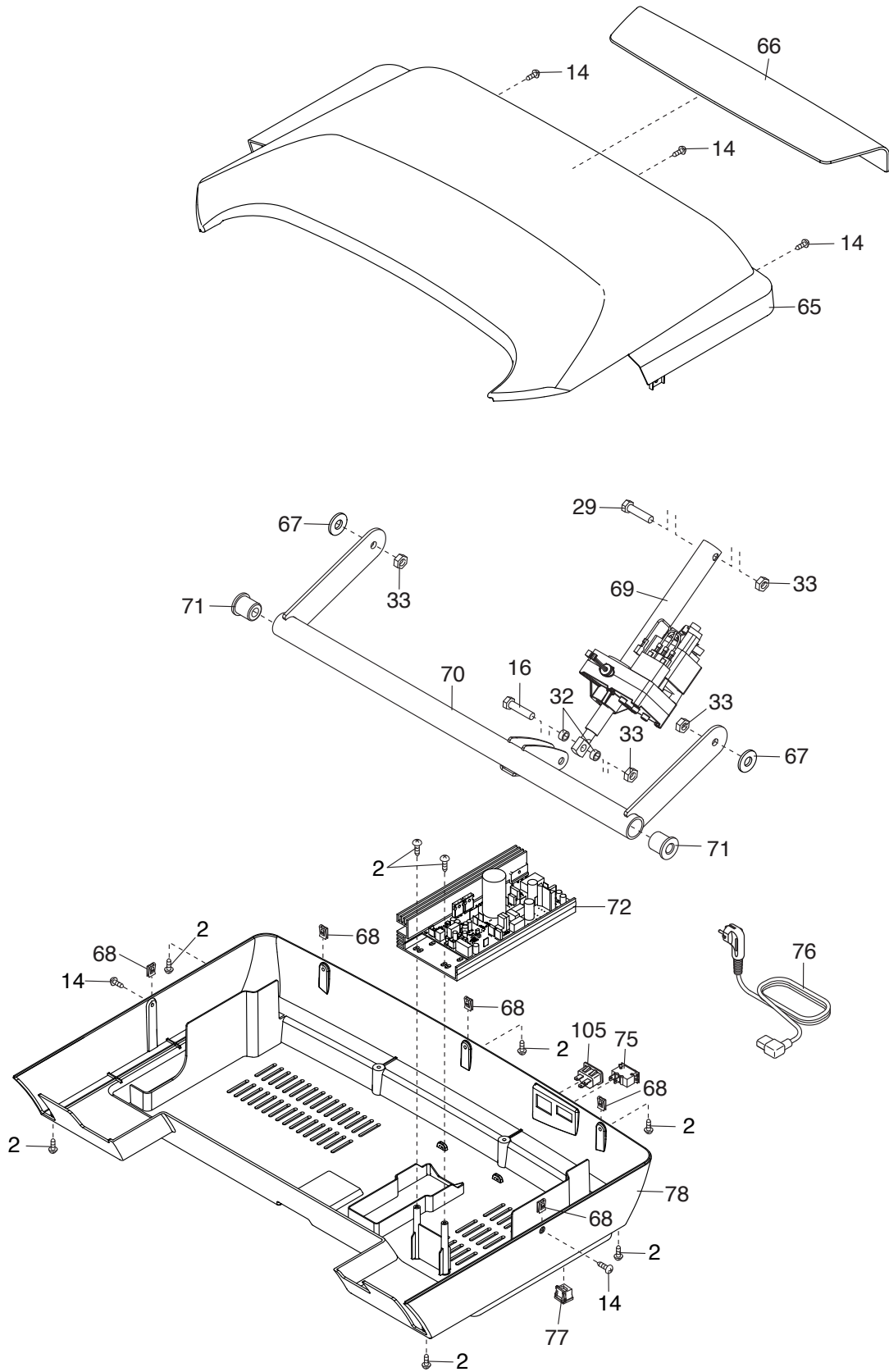

# EXPLODED DRAWING C

Model No. PETL12714.1 R0514A

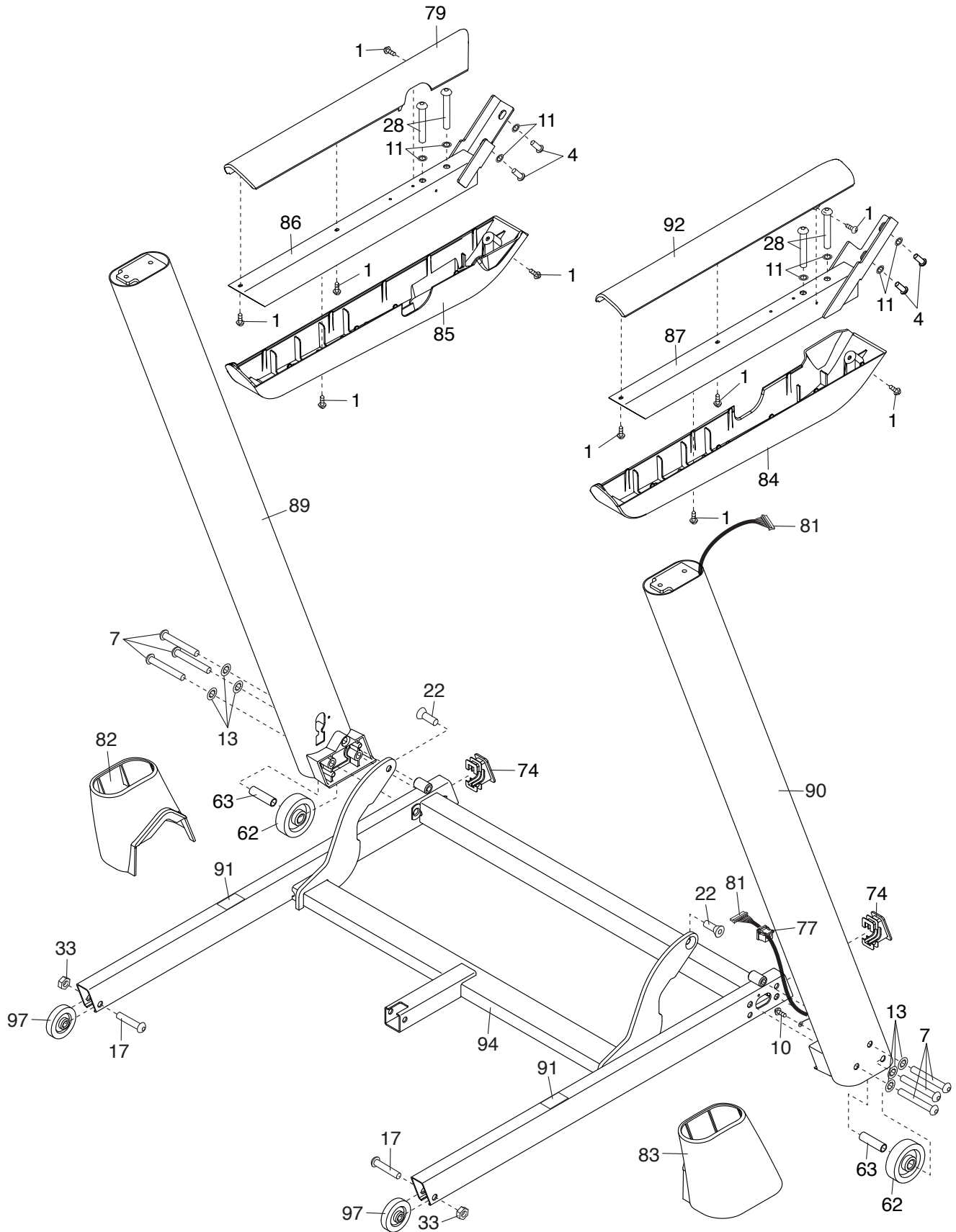

# EXPLODED DRAWING D

Model No. PETL12714.1 R0514A

