

EXPLODED DRAWING A

Model No. PETL12714.2 R1014A

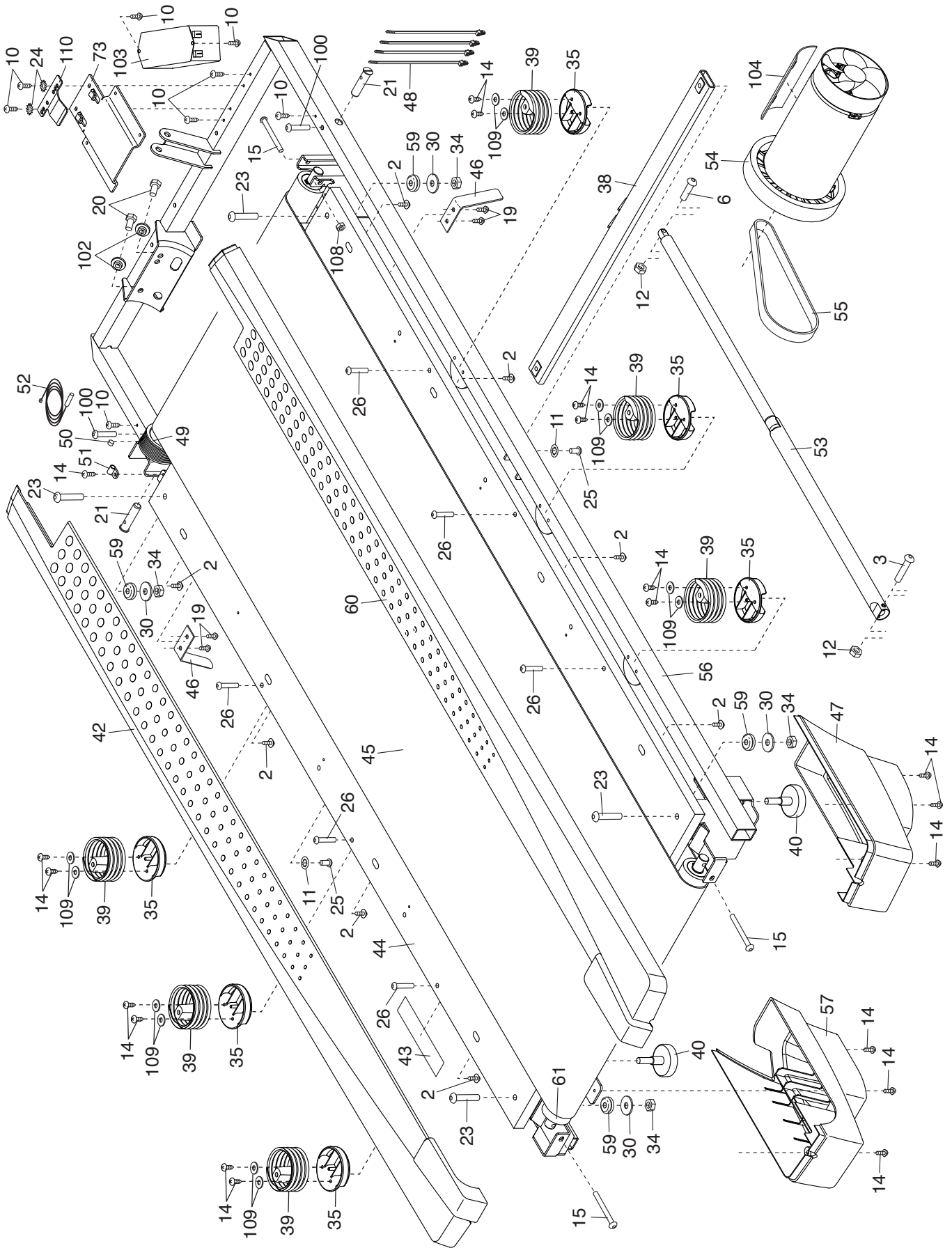

EXPLODED DRAWING B

Model No. PETL12714.2 R1014A

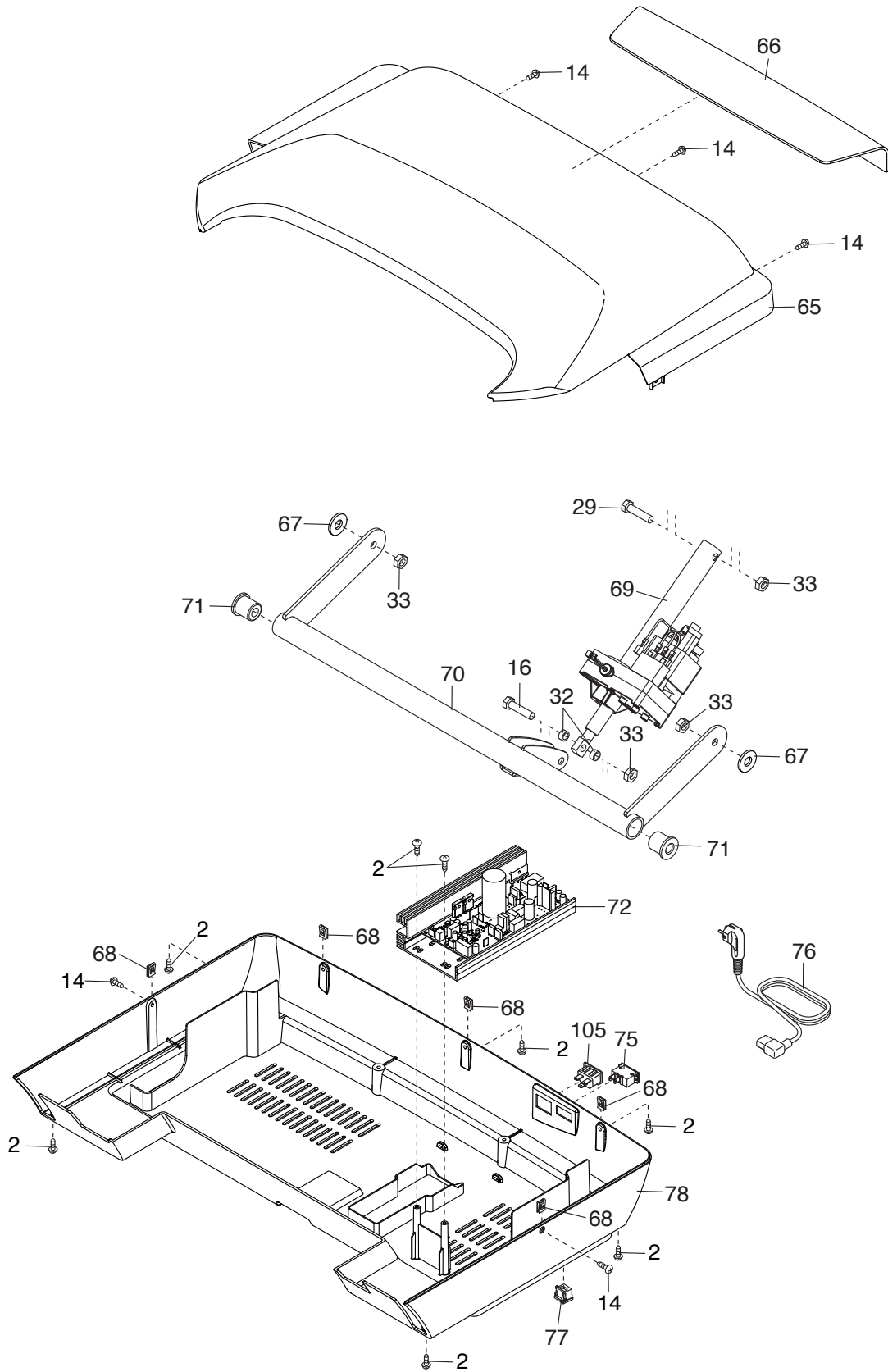

EXPLODED DRAWING C

Model No. PETL12714.2 R1014A

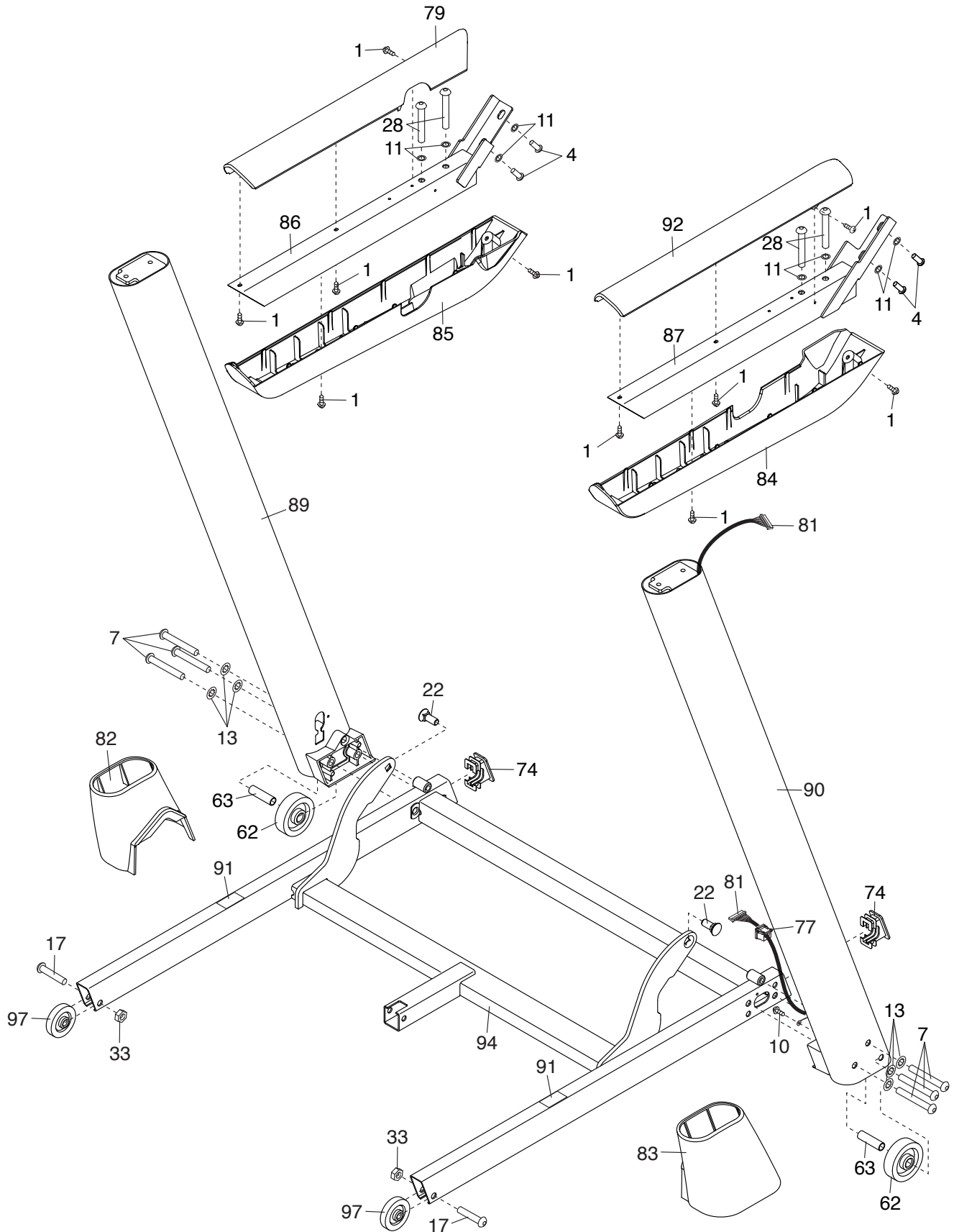

EXPLODED DRAWING D

Model No. PETL12714.2 R1014A

