

# EXPLODED DRAWING A

Model No. PETL13012.1 R0415A

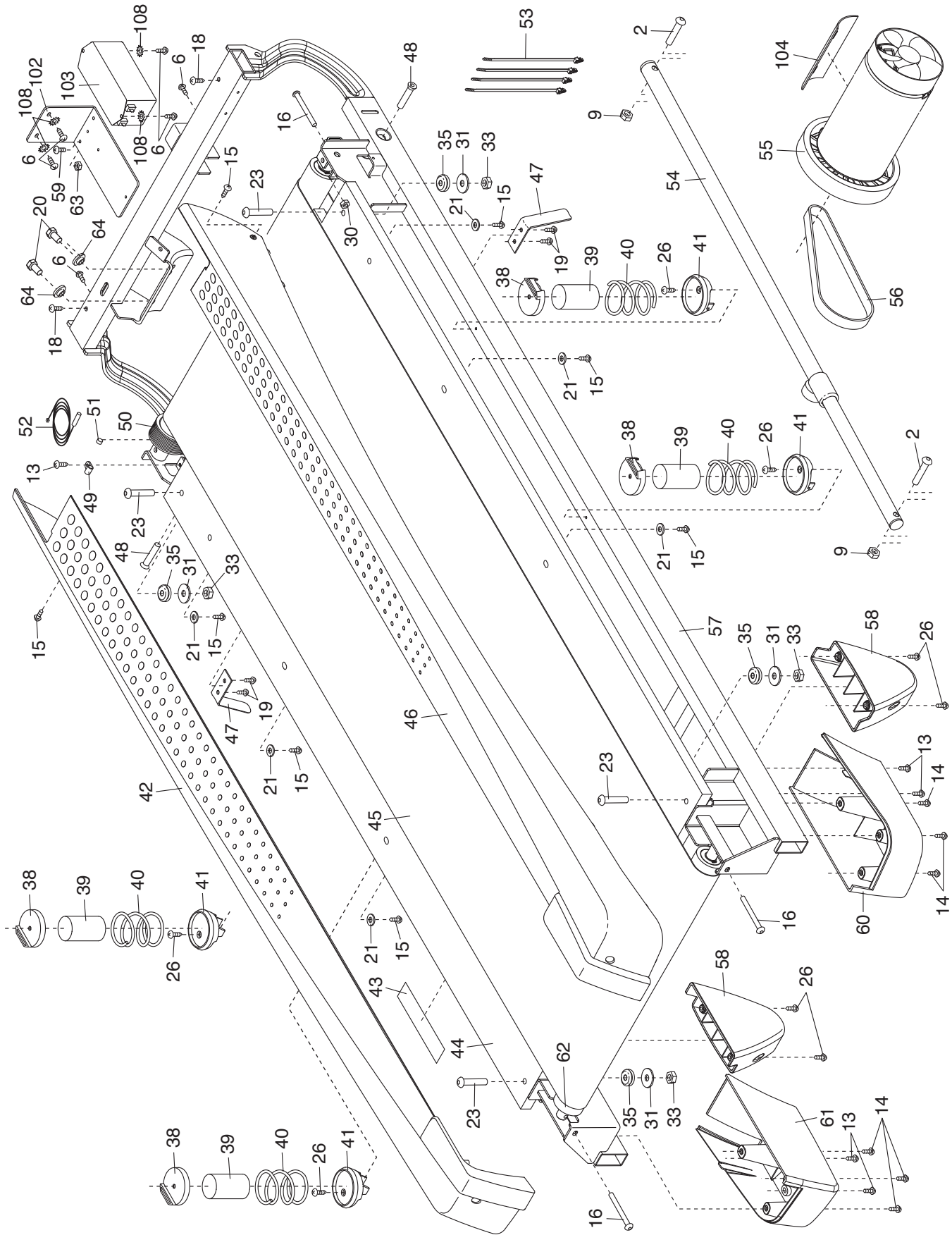

# EXPLODED DRAWING B

Model No. PETL13012.1 R0415A

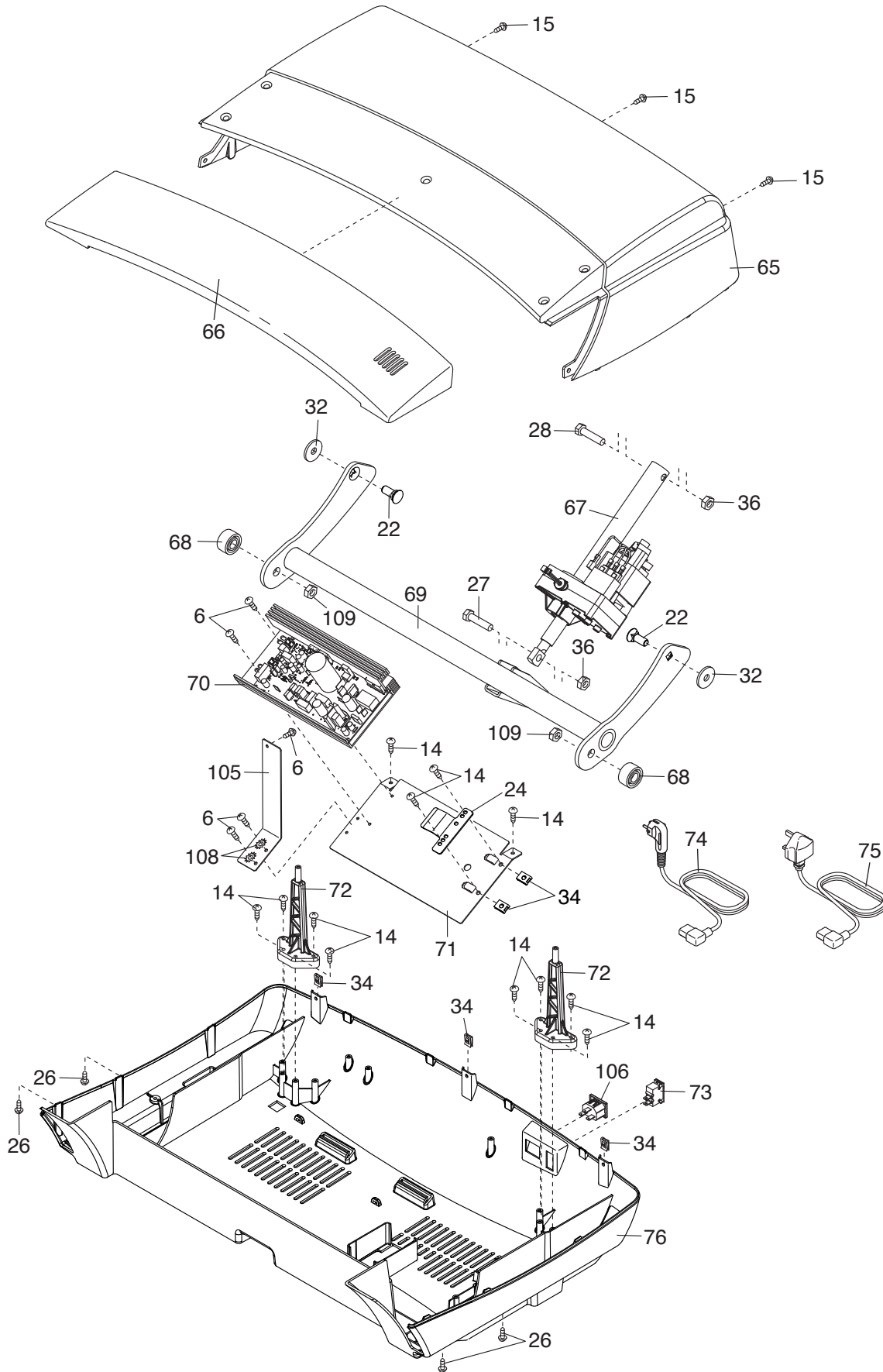

# EXPLODED DRAWING C

Model No. PETL13012.1 R0415A

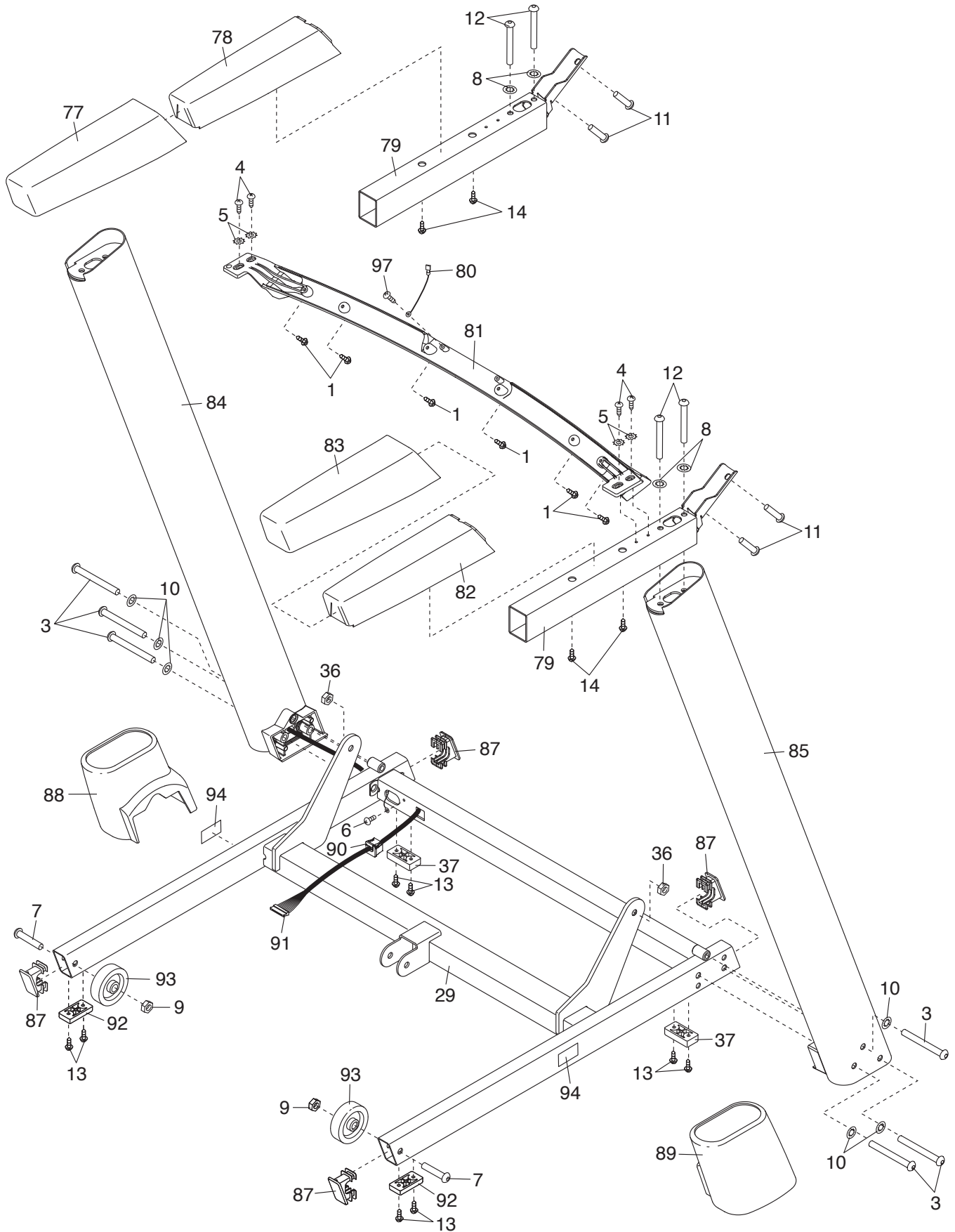

# EXPLODED DRAWING D

Model No. PETL13012.1 R0415A

