

# EXPLODED DRAWING A

Model No. PETL14713.0 R0413A

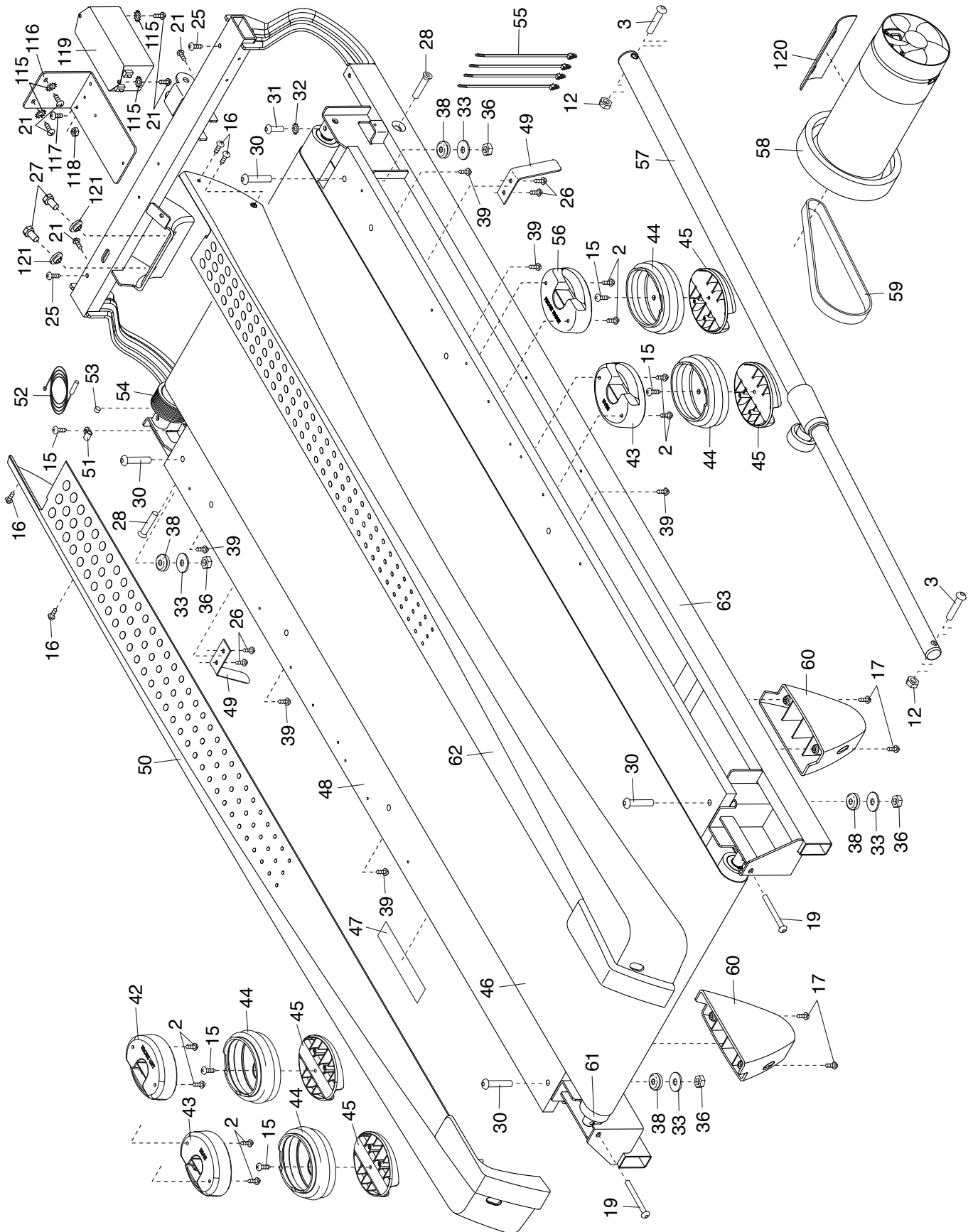

# EXPLODED DRAWING B

Model No. PETL14713.0 R0413A

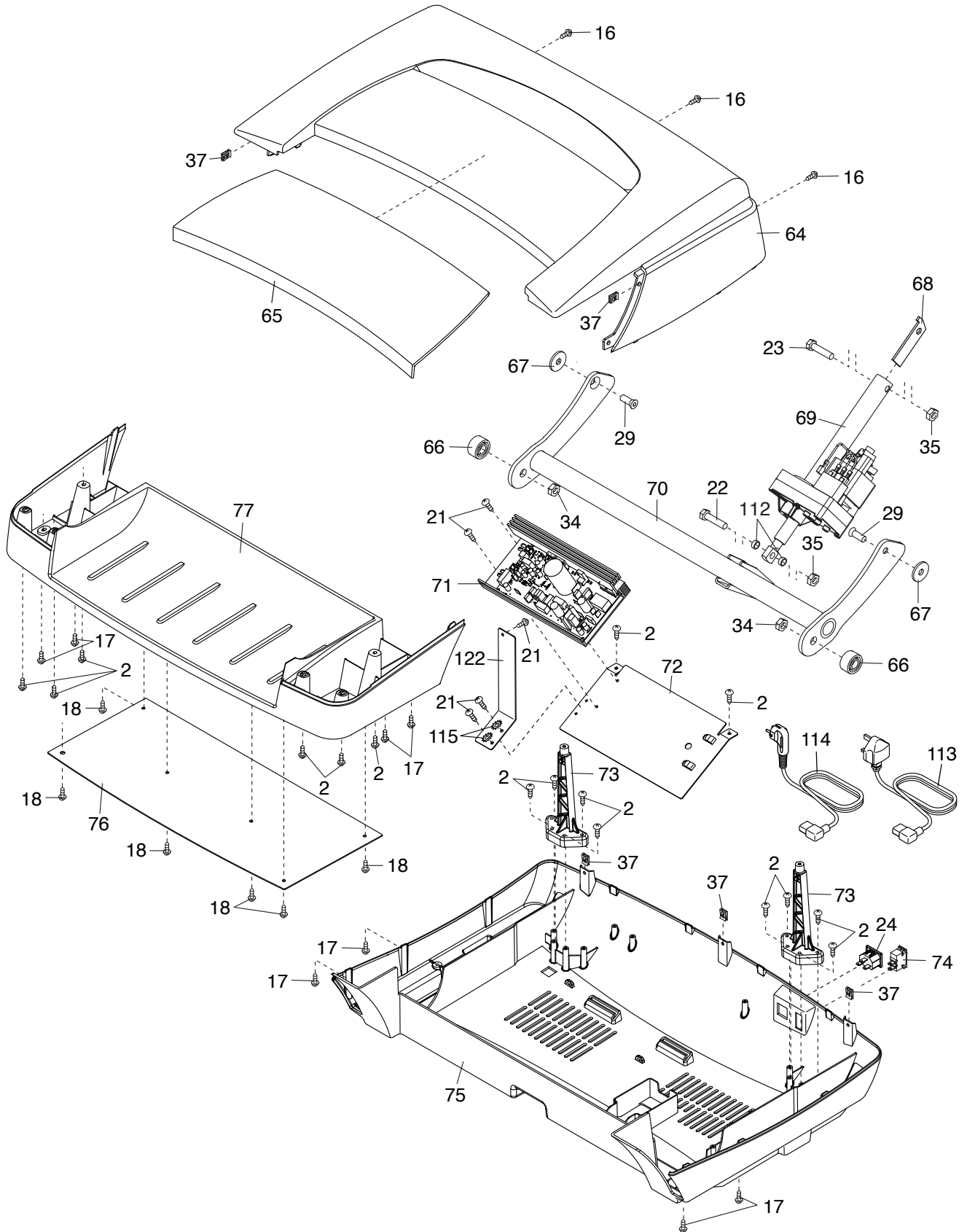

# EXPLODED DRAWING C

Model No. PETL14713.0 R0413A

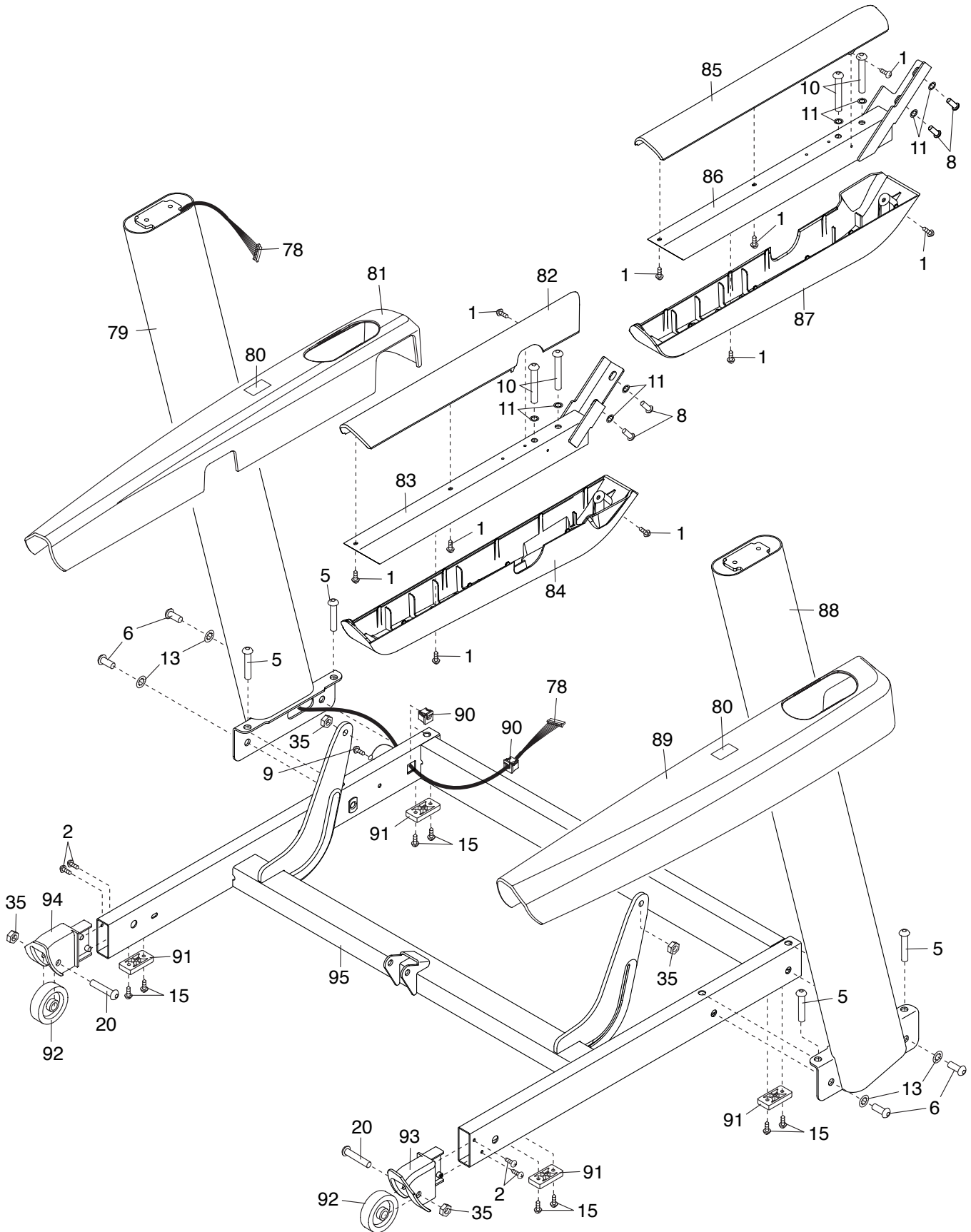

# EXPLODED DRAWING D

Model No. PETL14713.0 R0413A

