

EXPLODED DRAWING A

Model No. PETL14715.0 R0315A

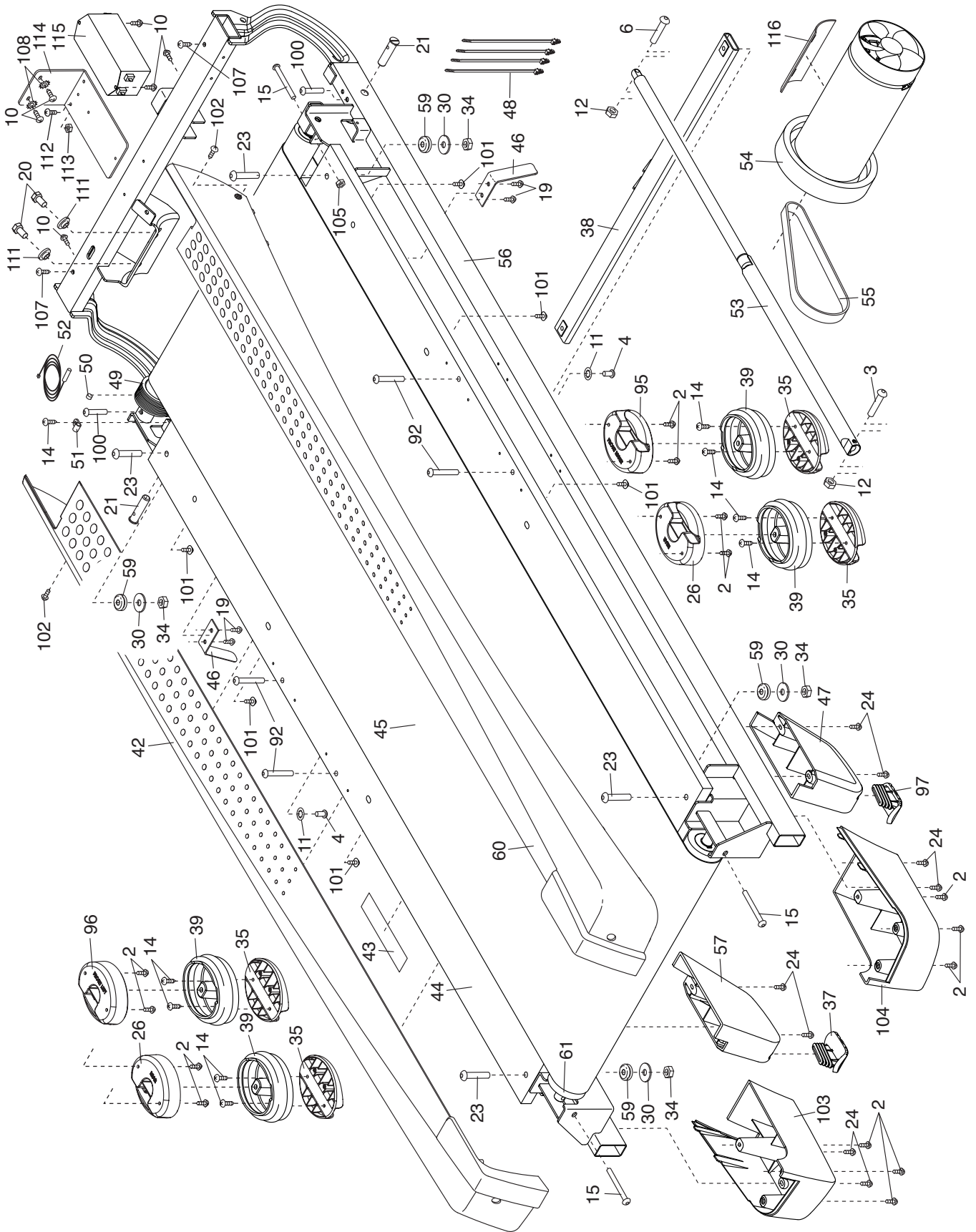

EXPLODED DRAWING B

Model No. PETL14715.0 R0315A

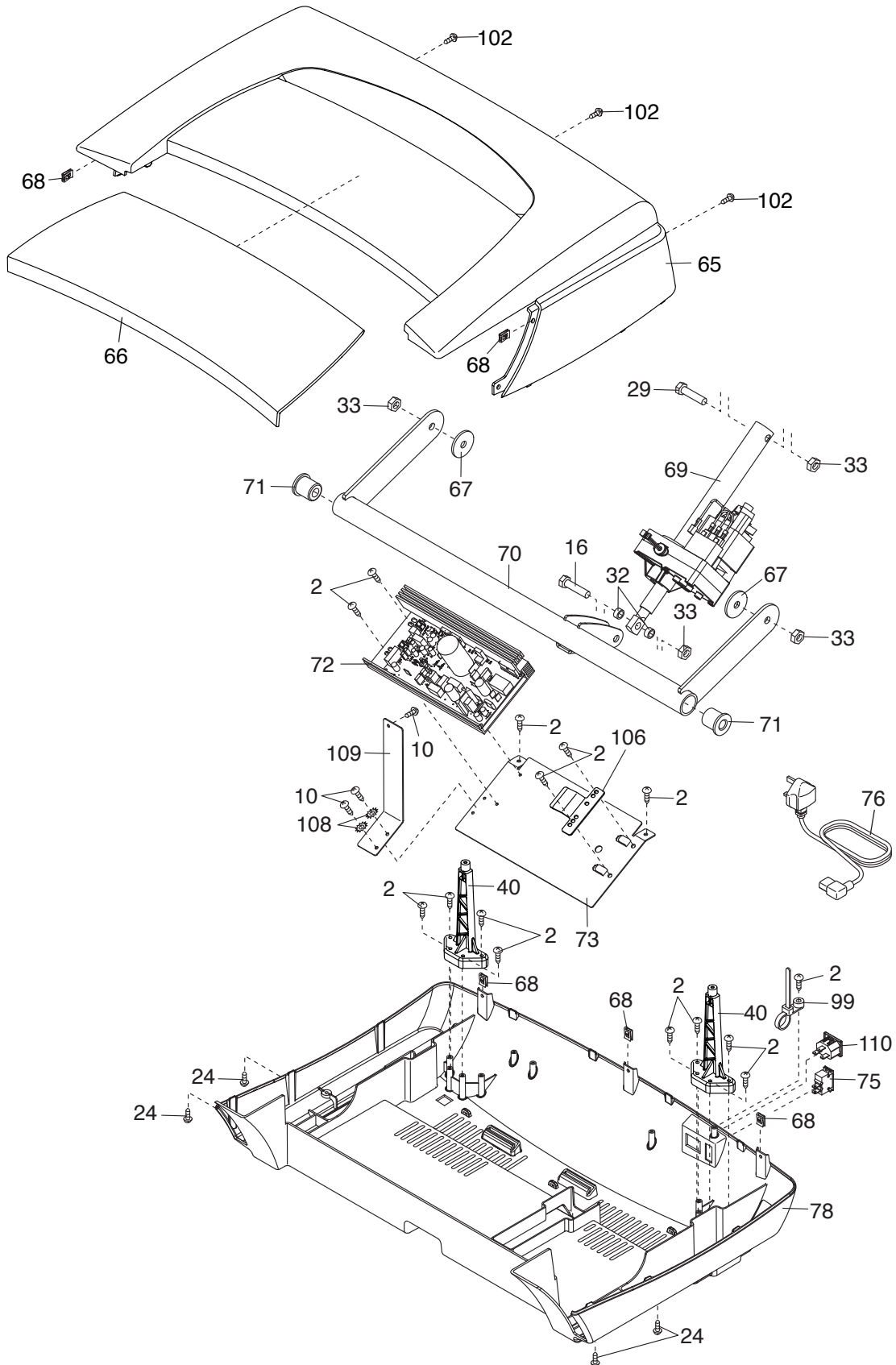

EXPLODED DRAWING C

Model No. PETL14715.0 R0315A

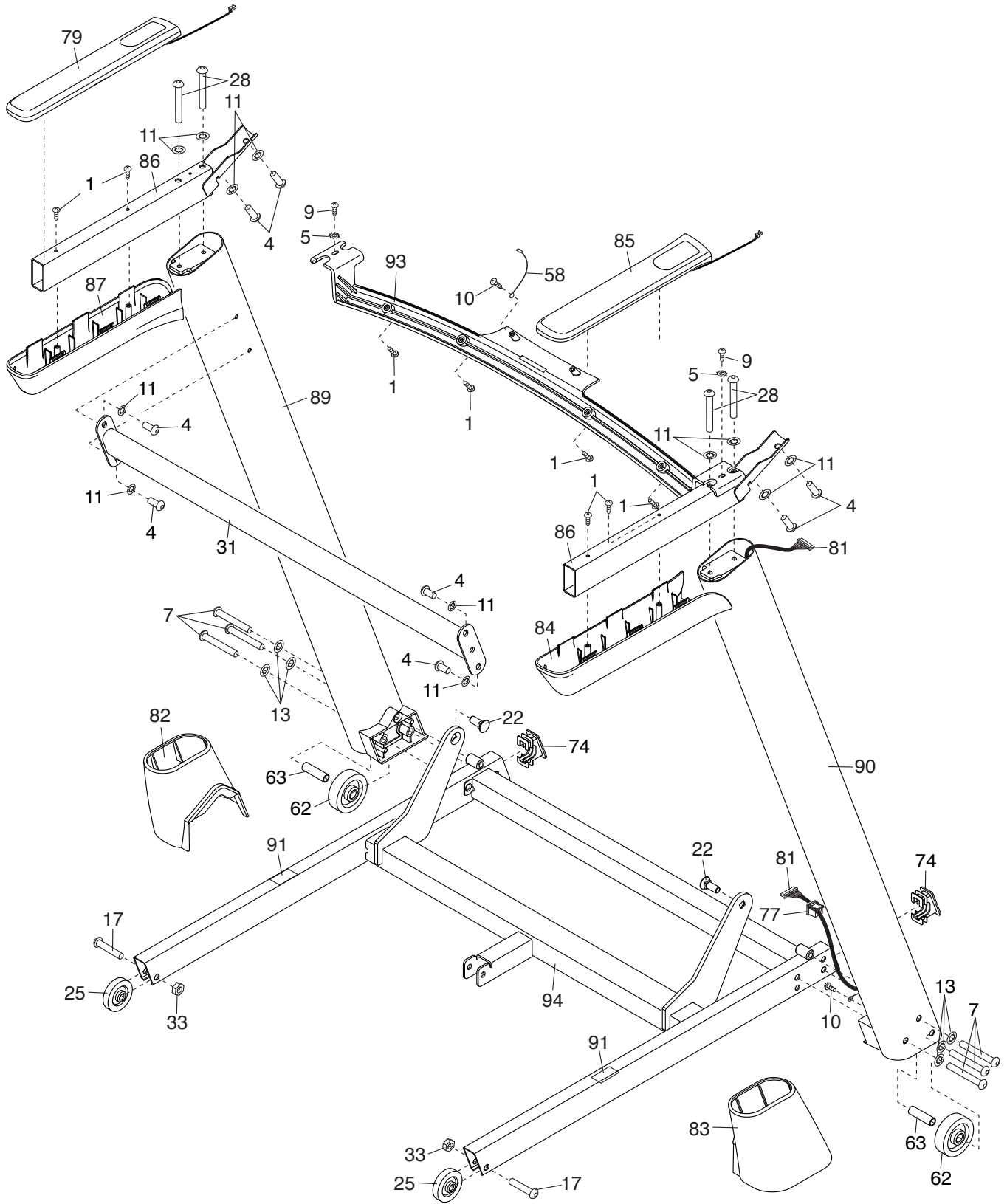

EXPLODED DRAWING D

Model No. PETL14715.0 R0315A

