

EXPLODED DRAWING A

Model No. PETL15618.0 R0618A

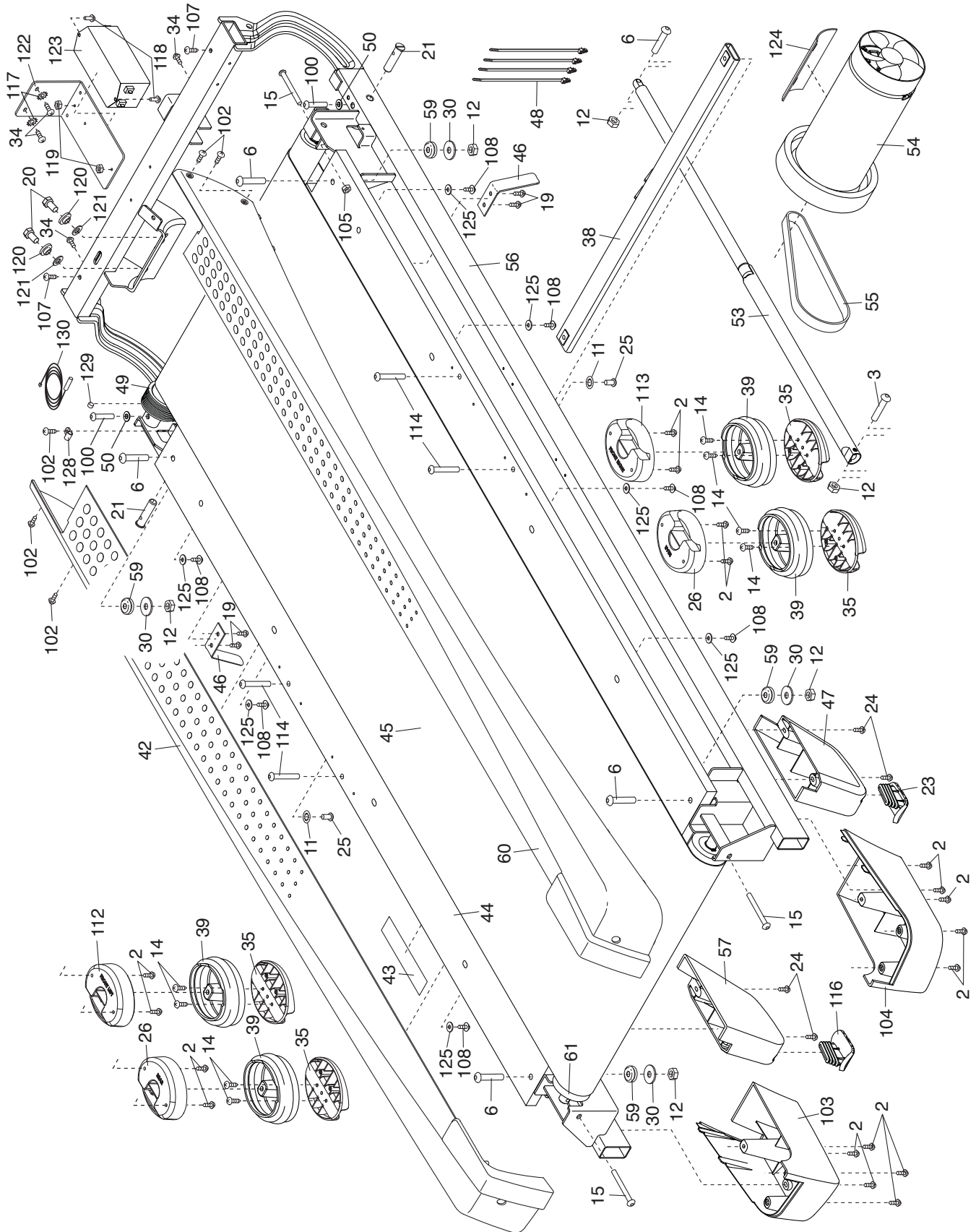

EXPLODED DRAWING B

Model No. PETL15618.0 R0618A

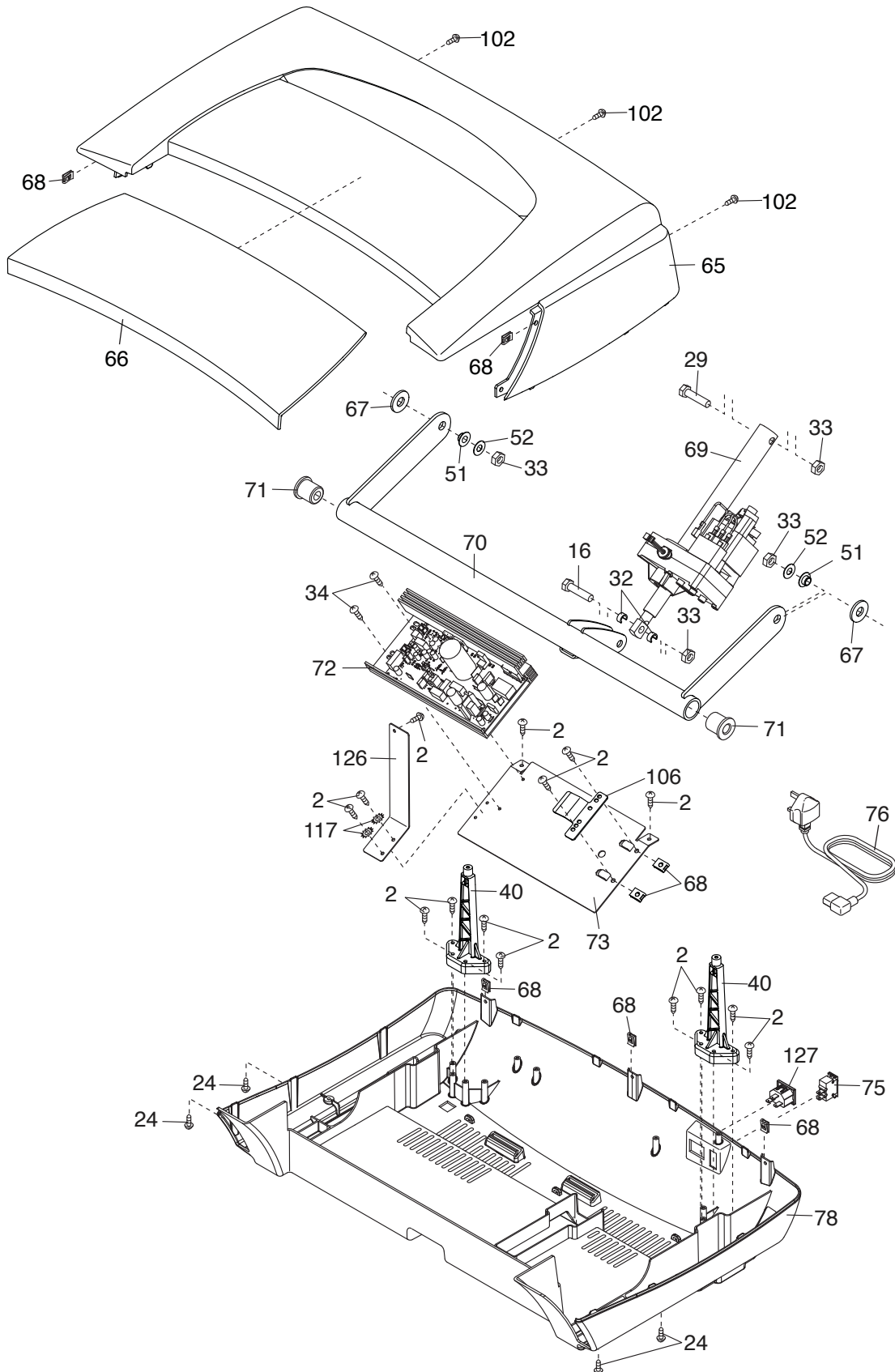

EXPLODED DRAWING C

Model No. PETL15618.0 R0618A

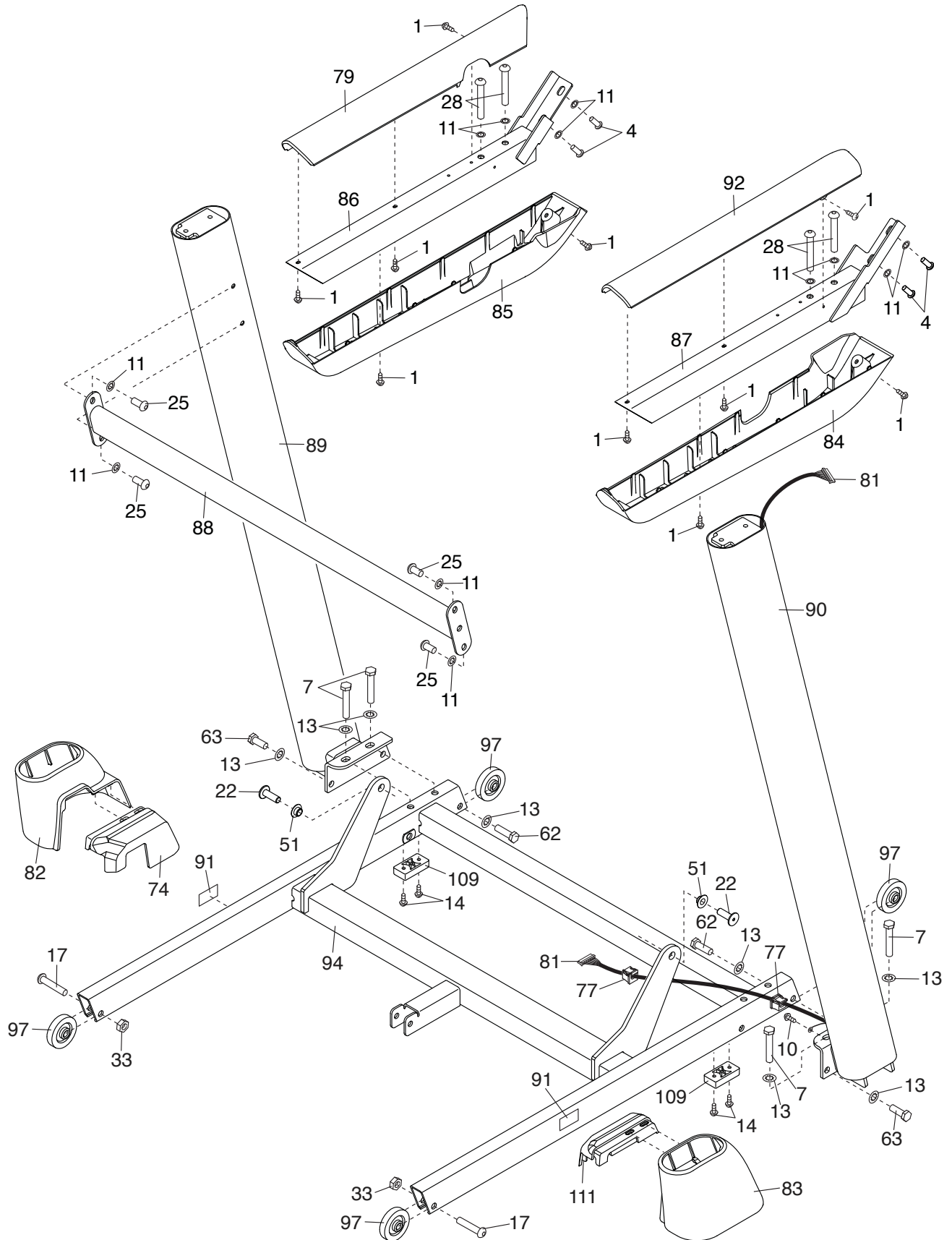

EXPLODED DRAWING D

Model No. PETL15618.0 R0618A

